

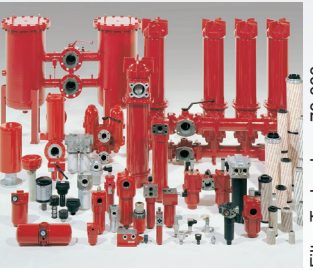

Accumulator Technology 30.000



Filter Technology 70.000



Process Technology 77.000



Filter Systems 79.000

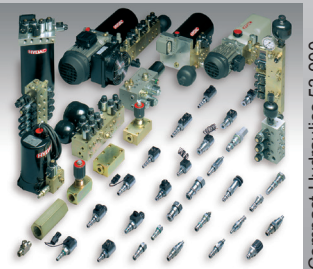

Compact Hydraulics 53.000



Accessories 61.000



Electronics 180.000



Cooling Systems 57.000

**Global Presence.
Local Expertise.
www.hydac.com**

HYDAC INTERNATIONAL

**Components,
Systems and Service
for Grinding Machines**



- HYDAC Head Office
- HYDAC Companies
- HYDAC Sales and Service Partners

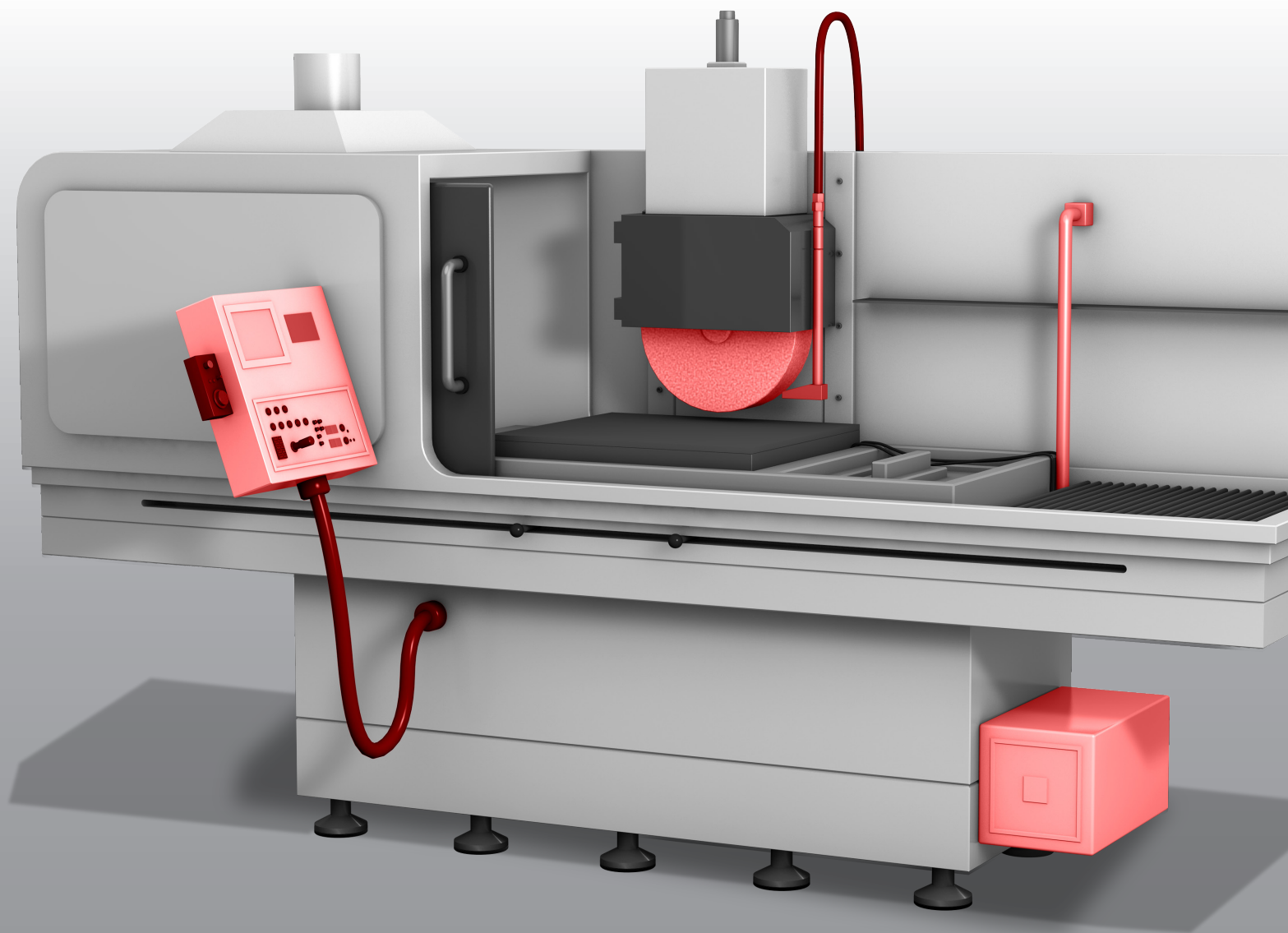

HYDAC INTERNATIONAL

HYDAC International
GMBH
Industriegebiet
66280 Sulzbach/Saar
Germany

Phone:
+49 6897 509-01
Fax:
+49 6897 509-577
E-mail: wzm@hydac.com
Internet: www.hydac.com



E 10.111.6.0/09.15

E 10.111.6.0/09.15

Grinding Machines: From the component to the system. Sensors, hydraulics, cooling and cooling lubricant.

HYDAC Your partner for expertise in grinding machines.

HYDAC has been one of the leading suppliers of fluid technology, hydraulics, electronics and cooling equipment for more than 50 years and has over 8,000 members of staff worldwide.

The breadth and depth of our product range, combined with our recognised expertise in development, manufacturing and service, allow us to provide solutions worldwide for the wide range of requirements in the machine tool industry.

In addition to standard products, HYDAC has a wealth of components specifically developed for use in grinding machines. These have evolved from the fields of hydraulics, cooling, electronics and cooling lubricant management. Intelligent integration of HYDAC products creates innovative and technologically advanced subsystems for use in grinding machines.

Customer benefits:

- Cost optimisation achieved by customised system solutions which use standard components
- Reduction in number of models through standardisation and modular construction
- **Global yet local:** More than 45 overseas companies and over 500 sales and service partners
- **Fluid engineering and service:** Support in technical design, in the case of complaints, commissioning, maintenance and training
- **Customised solutions:** Designs can be tailored to individual customer requirements – made-to-order solutions for your grinding machine

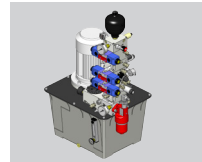

Compact power unit

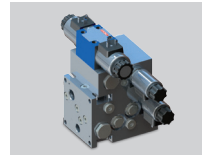

HL stacking system (top) and ML stacking system (bottom)



Fluid/air cooling system FLKS



Refrigeration cooling system RFCS

HYDRAULICS

Power units + controls for:

- Workpiece clamping
- Dressing procedure
- Tailstock traverse
- Lubrication
- Axis clamping
- Swivel arm operation
- Counterbalance
- Tool change

COOLING

Active and passive cooling systems for cooling of

- Grinding spindle and workpiece spindle
- Linear motors
- Axes
- Cooling lubricant
- Hydraulic oil
- Control cabinets

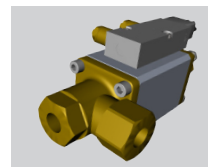

Coaxial valve CX

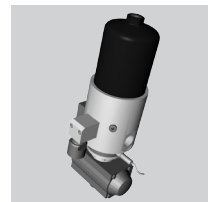

Automatic back-flushing filter AutoFilt® RF4

COOLING LUBRICANT

- Valves to supply:
 - Internal coolant to tools
 - Tool holder flushing
 - Machine bed flushing
 - External flushing of workpiece
- Fine filter to protect the valves, LP and HP pumps



Pressure switch EDS 3000

ELECTRONICS

Sensor systems and condition monitoring

Sensors for indication, checking and monitoring of

- Clamping pressure
- Fluid temperature
- Level of oils and cooling lubricants in the tank
- Flow rate
- Position and distance

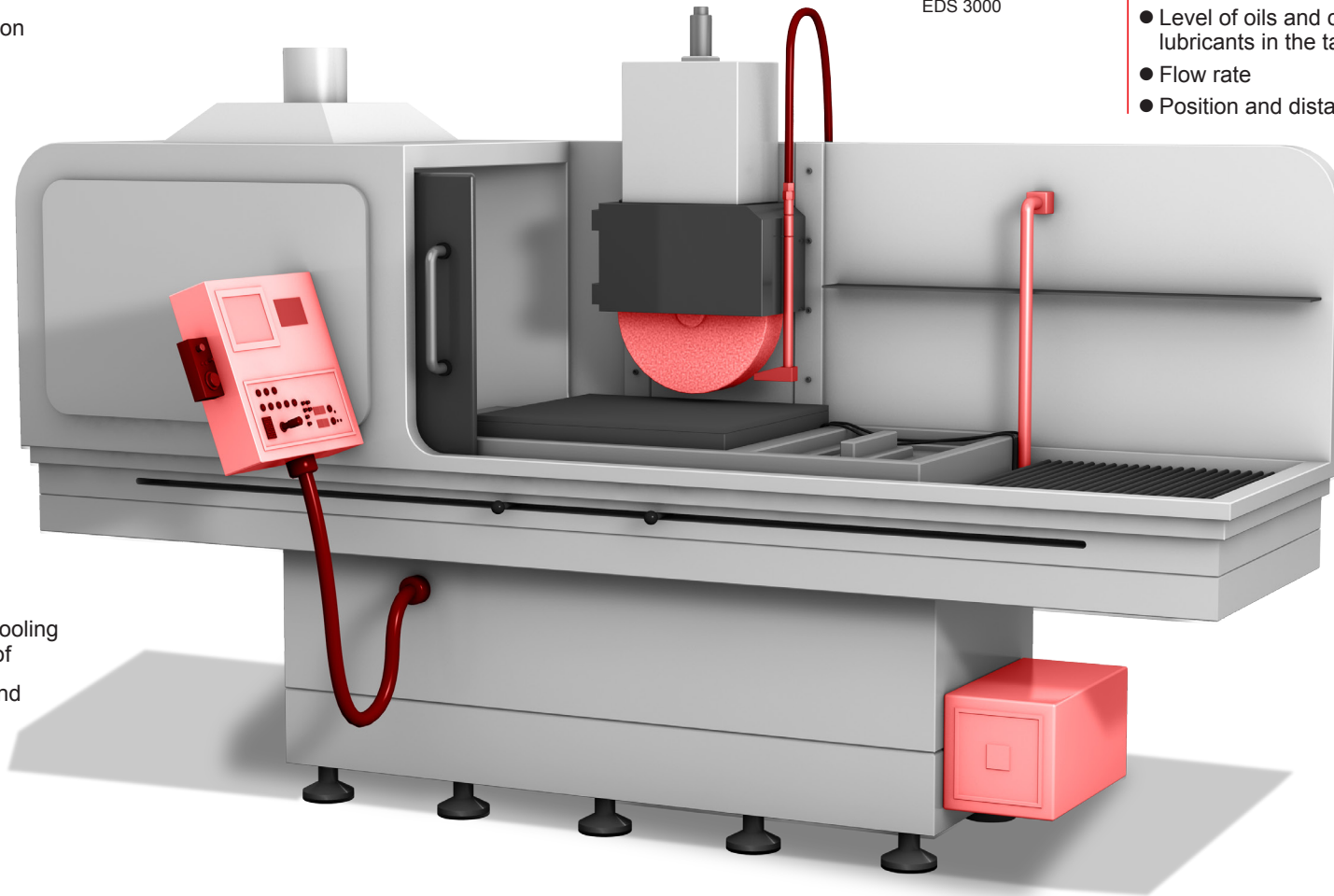

Fluid panel

SYSTEM SOLUTIONS

- Cylinder with integrated distance measuring system
- Hydraulic counterbalance to relieve the mass of vertical machining spindles
- Fluid panels including hydraulics, pneumatics, cooling lubricant, electronics, cooling and lubrication in a plug & play solution for your grinding machine

Electronics

Sensor systems and condition monitoring components contribute to increased productivity, a high level of machine safety, effective mechanical efficiency in the grinding machine and to achieving high quality machining. The HYDAC portfolio includes sensors to display, check and monitor the pressure, fluid temperatures, level in the tank, flow rate and workpiece support.



Pressure transmitters HDA 8000/
pressure switches EDS 3000

Pressure transmitters/ pressure switches

Features

- Robust wear-free measurement technology
- Long-term stability
- Simple and accurate adjustment:
 - manually e.g. based on a VDMA menu
 - automated e.g. via an IO link interface
- Application and customer-specific models
- Model for applications with increased functional safety and/or diagnostic function

Function

Reliable pressure monitoring is of prime importance for the function of the machine and the quality of the component.

Pressure transmitters and switches are deployed to monitor:

- clamping pressure
- workpiece support
- cooling lubricant system
- hydrostatic bearing
- accumulator charging pressure
- and the pneumatics

Advantages

- Long life and therefore greater machine availability
- Accuracy stability over the entire useful life
- Consistently high machining quality
- Time saving
- Optimised stock control
- Minimal operating errors
- Simplification or optimisation of the machine architecture
- Increase in machine safety



Linear position and distance sensors HLT 2500 profile design, HLT 2500 flat housing design, HLT 1000

Linear position and distance sensors

Features

- Distance sensors operate on the principle of magnetostriction in rod design (which can be semi- or fully integrated into cylinders), or are available for external installation in a flat housing or profile housing with position slides
 - Wear-free
 - High degree of accuracy
 - Model for applications with increased functional safety and/or diagnostic function
- Other linear position and distance sensors based on LVDT, Hall sensors, ultrasound and optical sensors

Function

Increasing demands for precision, machine availability and improved safety require reliable distance measuring technology which is perfectly adapted to the application.

Linear position and distance sensors are used in:

- Tailstock monitoring
- Valve position monitoring
- Position detection e.g. on locks
- Detection of traverse paths

Advantages

- Long life and therefore greater machine availability
- Consistently high machining quality
- Simplification or optimisation of the machine architecture
- Increase in machine safety



Level switch ENS 3000, level transmitter HNT 1000

Level switches/ level transmitters

Features

- Wear-free measurement
- Indication of fluid level
- Simple and accurate adjustment:
 - manually e.g. based on a VDMA menu
 - automated e.g. via an IO link interface
- Analogue resolution over the whole measurement range

Function

Level switches and transmitters are primarily used to measure the level of oils and coolants in the tank.

Advantages

- Long life and therefore greater machine availability
- Time saving
- Accuracy stability over the entire useful life
- Continuous, smooth level detection over the entire measurement range
- Active suppression of short-term level fluctuations



Temperature switches ETS 3000,
temperature transmitters ETS 4500 and HTT 8000

Temperature transmitters/ temperature switches

Features

- Robust wear-free measurement technology
- Long-term stability
- Simple and accurate adjustment:
 - manually e.g. based on a VDMA menu
 - automated e.g. via an IO link interface
- Application and manufacturer-specific models

Function

A consistently high product quality can only be achieved when the machining tools are at a constant temperature.

Temperature transmitters and switches are used to monitor the temperature of cooling media and hydraulic fluids.

Advantages

- Long life and therefore greater machine availability
- Accuracy stability over the entire useful life
- Consistently high machining quality
- Time saving
- Optimised stock control
- Minimal operating errors
- Simplification or optimisation of the machine architecture

Hydraulics

To enable complete machining with just one clamping operation, grinding machines come in a variety of designs. Different combinations of normal and angled compounds slide rest, grinding spindles and double grinding spindles result in a range of variants and functions. The HYDAC compact power unit, in combination with the HL or ML valve stacking system which acts as the control logic, serves all the main and secondary hydraulic functions such as workpiece clamping, dressing procedure, workpiece spindle clamping, grinding spindle turret, counterbalance, axis clamping and lubrication.

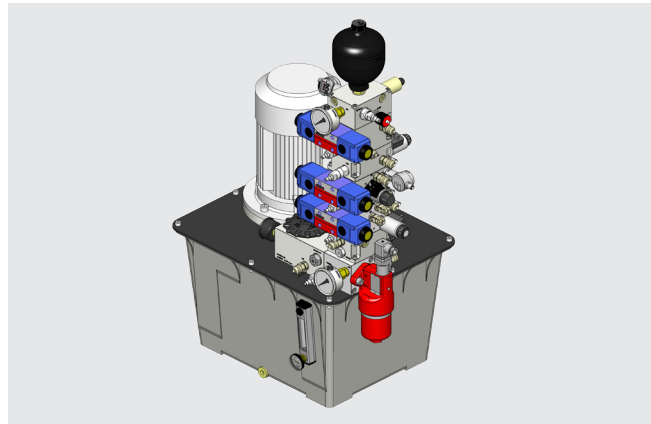
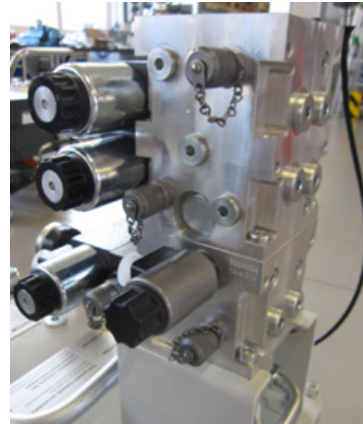

Compact power unit

Features

- Energy-efficient design, integrated accumulator and charge control as well as appropriate tank volume
- Modular power unit in AC or 3-phase AC design
- Needs-based energy supply due to short-time duty S2, intermittent periodic duty S3 and continuous operation with intermittent load S6
- Unique valve block design with the option of adding on additional blocks
- Aluminium/steel blocks designed for up to max. 60 l/min at 250/350 bar
- Control of consumers made flexible by combination of double pumps
- Low-noise motor/bell housing design
- Components have been service-life tested, proving themselves over many years, and thus guarantee excellent availability

Function

The HYDAC compact power units have a high level of operational reliability and a long service life. All components are mounted on the cover of the oil tank for easy access. An air-cooled AC or 3-phase AC motor drives the self-priming pump. The pressure is then available to the consumer at outlet "P". A pressure relief valve with a fixed setting prevents pressure from rising to an impermissible level. The return oil is fed back into the tank via a return line filter. As an option, an oil/air cooler or oil/water heat exchanger can also be installed to keep the oil at the desired operating temperature.

Function

- Energy efficiency
- Very low-noise
- Varied monitoring functions available: oil pressure, oil level, oil temperature, filter clogging indicators, water content, oil purity sensors and many more
- Reliability

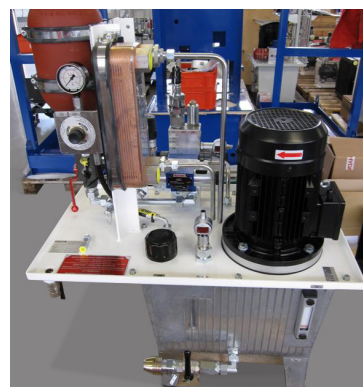
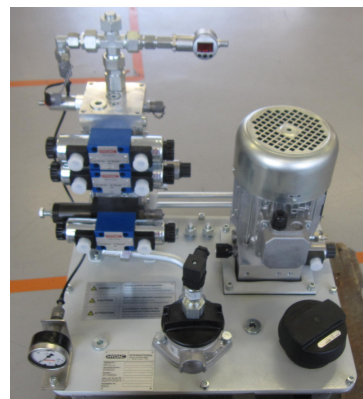

Function

The manifold stacking system is a new type of control logic for machine tools.

It consists of individually combined standard modules. Each function module can be used both independently and in stacking configurations. The sequence of modules depends on the control task, as does the use of pressure, flow control, shut-off and directional control valves on the module.

The system can easily be customised as extending and replacing is very simple.

Advantages

- Energy efficiency
- High level of integration
- Plug and play
- Reliability

Function

The ML valve stacking system is a control for oil hydraulic systems consisting of individual standard modules. This system is designed chiefly for controlling low-volume consumers and for pressure/force resistance tasks. The ML stacking system can be used both as a stand-alone hydraulic control and in combination with a HYDAC compact power unit.

Advantages

- Zero leakage
- Modular

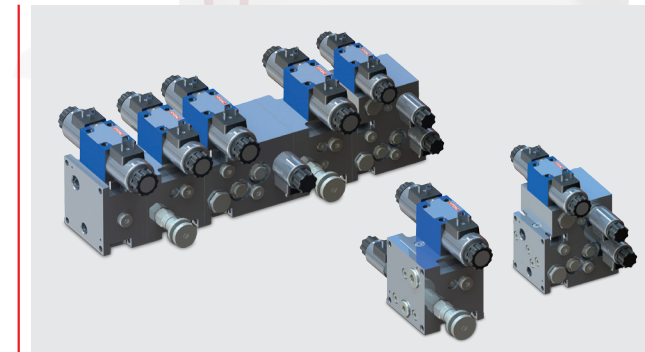
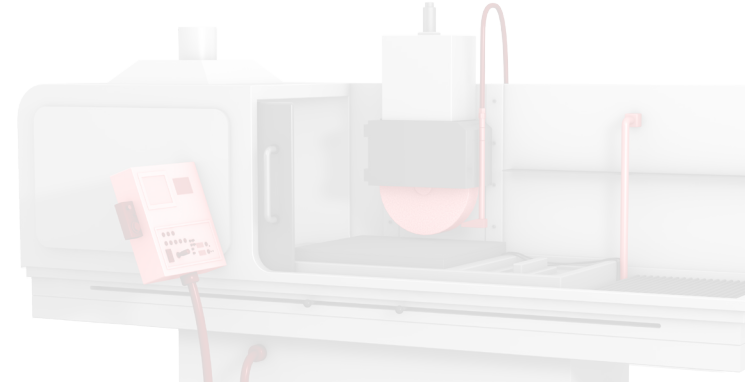

Stacking system

Individual modules for different applications

HL controls

Features

- Can be used as individual modules or in stacking configurations locally in the machine
- Installed close to the particular actuator
- Can easily be extended to achieve the required range of functions
- Tried-and-tested cartridge valve technology in conjunction with Cetop valves in completely re-designed and Δp -optimised, modular housings
- High energy saving potential due to zero-leakage cartridge poppet valves in conjunction with an accumulator charging function
- Modular design with a range of standardised valve cavities to offer a wide selection of circuits

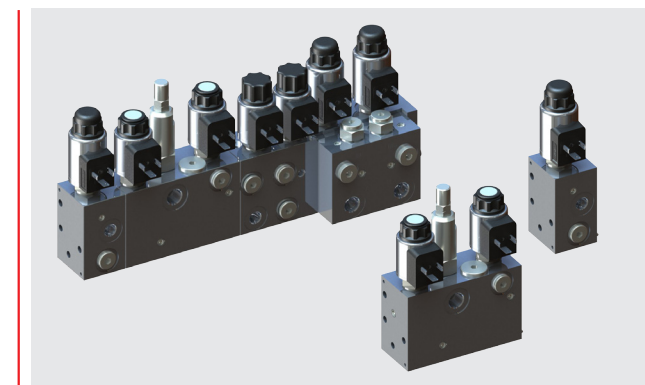

Valve stacking system ML

Features

- Zero-leakage directional poppet valves provide secure positioning of the consumer and maintain the pressure over a prolonged period without repeated oil supply
- Various base and function modules for individual control of the hydraulic consumers
- The smallest dimensions provide high power density through the use of cartridge valve technology
- Can be flanged directly to the CO1 power unit
- The ML valve stacking system combines with the CO1 hydraulic power unit to form a ready-to-install oil supply unit
- Function modules can be extended at a later date

Cooling Lubricant

To supply cooling lubricant, HYDAC offers piston control or coaxial valves. Where driven tooling with an internal coolant is used, inline, duplex change-over and back-flushing filters are available to protect the high pressure pumps.



Piston control valve



Piston control valve – modular design



Coaxial valve in modular design



Change-over inline filter FLND



Automatic back-flushing filter AutoFilt® RF4

Piston control valves Pilot-operated: For maximum reliability

Rating

- Nominal size: DN15–DN50
- Pressure range: 0–25 bar
- Flow rate: 77–792 l/min
- Connection type: G1/2"–G2"

Features

- High flow rates with low pressure loss
- For temperatures from –40 °C to 200 °C
- Compact design
- Material: red brass or stainless steel

Function

The 2/2 directional piston control valves are externally controlled poppet valves. They are controlled/actuated against a spring force via a piston drive element with the help of a clean control medium (e.g. neutral gases), relatively independent of high temperatures, large operating pressures and contaminated media.

Control is provided by an external 3/2 directional control valve (pilot valve) that is mounted either directly on the drive or inside the control line.

The valves operate in a pressure range from 0 bar to the maximum operating pressure and they open, or close, (depending on the operating direction) with spring force when the signal is lost.

Advantages

- Very high level of reliability
- Space-saving and maintenance-friendly
- Rotatable drives
- High flow rates
- Contamination-resistant and durable

Coaxial valves Direct-acting & pilot-operated: Available as individual valves and in modular design

Features

- High flow rates with low pressure loss
- Flow rates up to 47.2 m³/h = 787 l/min
- Safety assured by proven technology and experience
- Compact design
- Robust design and high level of protection against back pressure

Function

Coaxial valves open and close by axial movement. By means of compressed air or solenoid force, a tube is moved in a horizontal direction and thus opens the valve seat. Coaxial valve technology is a tried-and-tested means of controlling different types of media, e.g. vacuum, gaseous, fluid, abrasive, contaminated and aggressive, and is therefore universally applicable. A broad range of sizes and connection types, together with seal materials and housing materials which are compatible with the medium, make it possible to develop tailor-made solutions for an almost unlimited range of applications.

Advantages

- Rapid opening and closing times
- Highly contamination-resistant and durable
- High Kv values and viscosities are possible, therefore also suitable for colloidal, highly viscous, pasty and contaminated media
- Very compact design
- The geometry of these valves allows them to be built as module blocks (spacesaving, maintenancefriendly and minimises the installation expense)
- No pressure differential required
- Resistant to back pressure and flow possible in both directions

Inline filters DF / FLND / FMND: Finest filtration to protect the components

Features

- Removal of solid particles from cooling lubricants
- Filtration ratings from 5 to 50 µm
- Flow rate up to 400 l/min
- Pressure up to 100 bar (others on request)
- Filters to DIN 24550 available
- Change-over filters possible

Function

As the fluid passes through the filter element, the particles are retained and become embedded in the deep structure of the element. The large internal surface provides a high contamination retention capacity and long filter service life. The excellent filtration of even the smallest particles protects the downstream components, such as the rotary joint, internally cooled tools and high pressure valves, from damage.

Advantages

- Desired cleanliness class is guaranteed
- Protects downstream components
- Low pressure drops
- Compact and space-saving design
- 24 hour operation with duplex change-over filters
- Low leakage when changing element
- Available with/without bypass valve

Automatic back-flushing filter AutoFilt® RF4: Tried-and-tested function principle, compact design

Features

- Separation of solid particles from low viscosity fluids
- Filtration ratings from 25 to 100 µm
- Flow rates up to 200 l/min
- Compact design
- Efficiency thanks to automation
- Performance enhanced by isokinetics
- Safety assured by proven technology and experience

Function

The medium flows through the filter elements from the inside to the outside. Contamination particles then collect on the inside of the filter elements. As the level of contamination increases, the differential pressure between the contaminated and the clean side of the filter increases. When the differential pressure reaches the pre-set trigger point, back-flushing starts automatically.

Advantages

- Fully automatic operation
- Ready-to-operate unit
- Maximum utilisation of the filter area
- Full filtration performance following back-flushing
- Complete cleaning of the conical filter elements
- Low maintenance costs
- Low operating costs
- Compact unit

Cooling

Active and passive cooling systems for cooling the spindles, motors, axes, control cabinets and fluids in grinding machines. High power motor spindles require a reliable and fault-free fluid system with which other drives can also be cooled if necessary. The return cooling can be achieved by means of an air, water or refrigeration system.

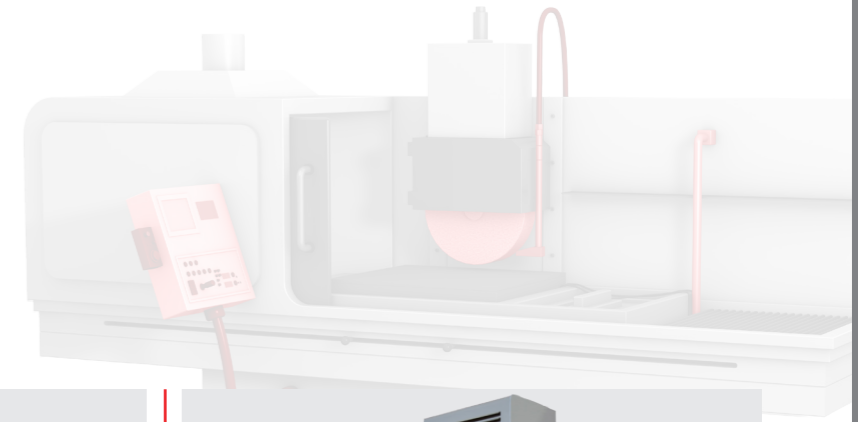

Fluid/air coolers FLKS

Fluid/air cooling systems FLKS

Features

- Cooling of circuits which use mineral oil or water glycol
- Compact design with plastic tank, circulation pump, cooling element and fan
- Various sizes with cooling capacities up to 1.05 kW/K and flow rates up to 150 l/min

Function

The cooled operating fluid is pumped from the tank through the drive being cooled and the fluid absorbs heat from the drive. The hot operating fluid flows through the heat exchanger and is cooled again by the air flow created by the installed fan.

Advantages

- Cost-effective and efficient cooling system
- Sizes FLKS-1, FLKS-2 and FLKS-4 with plastic tank housing
- Energy efficient because small drives are used and heat is dissipated directly to the environment
- Systems with closed-loop speed control (optional):
- A defined differential to the ambient temperature controls the temperature of the medium by varying the fan speed.

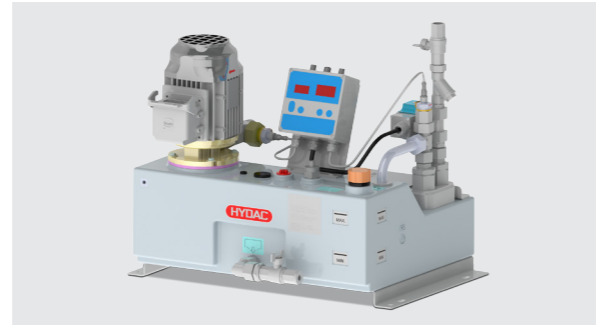

Fluid/water coolers FWKS

Fluid/water cooling systems FWKS

Features

- Cooling of circuits which use mineral oil or water glycol
- Compact design with plastic tank, circulation pump and plate heat exchanger
- Various sizes with cooling capacities up to 100 kW and flow rates up to 150 l/min
- Can be used as a temperature-controlled intermediate circuit. In this way the contamination and corrosion in the coolant circuits which could arise as a result of direct cooling with poor water quality is prevented.

Function

The cooled operating fluid is pumped from the tank through the component being cooled and the fluid absorbs heat from the component. The hot operating fluid flows through the plate heat exchanger where it is cooled again by the cooling water.

Advantages

- It is also possible to cool to temperatures below the ambient temperature (depending on the temperature of the available cooling water)
- Low heat dissipation to the environment and low noise emissions
- Thermostatically or electronically controlled proportional valve available as an option: the temperature of the operating fluid can thus be maintained at a specific temperature value.



Refrigerated fluid cooler RFCS

Refrigerated fluid cooler RFCS

Features

- Fluid cooling system as separate auxiliary cooler or for integration into a machine
- Cooling capacities from 1 to 160 kW
- Can be used for all cooling tasks in grinding machines
- Stand-alone control of the system by means of innovative controller design
- Condenser available as water-cooled or air-cooled variant
- Several cooling circuits possible
- Precise temperature control accuracies from ± 0.1 K

Function

The RFCS refrigerated fluid cooler system cools various fluids such as water, water glycol and oil. The cooling system, which consists of a chiller, pump, tank and control, operates independently to a specific setpoint. The energy-efficient, patented mixer principle, combined with a seal-less submersible pump, makes this system the ideal component for grinding machines.

Advantages

- Leakage-free, seal-less submersible pump
- Compact dimensions
- User-friendly control interface
- Cleanable air filter
- Plug & play solution
- Easy to service and user-friendly



Control cabinet cooler HCC

Control cabinet cooler HCC

Features

- Control cabinet cooler for roof installation or wall/door mounting
- Cooling capacities from 0.1 to 15 kW
- For all cooling applications in switchgears and control cabinets
- Stand-alone control of the system by means of innovative controller design
- Air/air or air/water coolers are also available

Function

The HCC control cabinet cooler system is flexible in its installation and designed to cool switchgears. Special heat exchanger designs ensure energy-efficient operation and a high level of operational reliability. Regardless of the version used, whether air/air, air/water or refrigeration, the HCC series ensures optimal conditions and improved service life for the electronic components.

Advantages

- Compact construction
- Innovative heat exchanger designs
- Optimal separation of condensate
- User-friendly control interface
- Plug & play solution

Modular design: 4-in-1

Features:

By combining standardised coolant reservoirs and pumps, 4 different systems can be created:

- ① FWKS
- ② FLKS
- ③ RFCS with air-cooled condenser
- ④ RFCS with water-cooled condenser

Advantages:

- The most appropriate system can be used according to the circumstances: Is cooling water available? Are the ambient temperatures too high? Must a high degree of accuracy be maintained?
- Switching between the systems is simple because the customer-side interfaces are in the same place on all systems
- Standardised system footprint
- Energy efficient thanks to
 - electronic control of the FWKS
 - closed-loop speed control of the FLKS
 - mixing control of the RFCS



① Fluid/water cooling systems FWKS

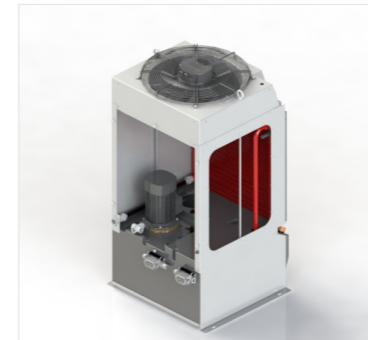

② Fluid/air cooling systems FLKS

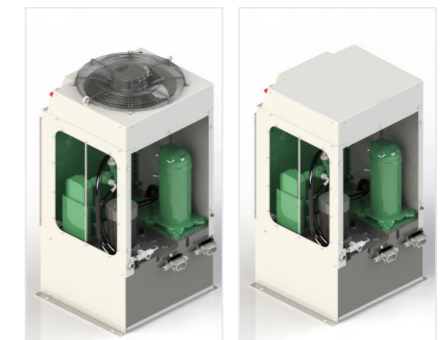

③ ④ Refrigeration cooling system with air/water-cooled condenser

System Solutions

From the component to the system! Intelligent integration of HYDAC products creates innovative and technologically advanced subsystems and complete systems. The cylinder with integrated distance measuring system, the hydraulic counterbalance and the HYDAC fluid panel minimise the number of interfaces, reduce the installation cost and increase machine availability.

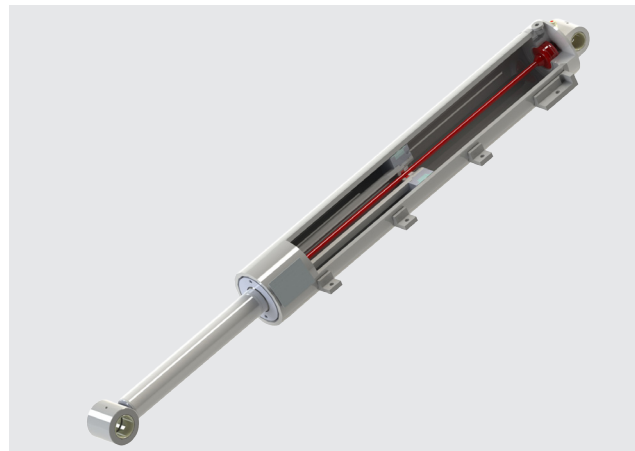

Cylinder with integrated distance measuring system

Features

The cylinder with integrated distance measuring system is suited to precise control of motion sequences in machine tools. Examples are tailstock traverse, steady traverse or palette change.

- Cylinder size: 40–80 mm piston diameter
- Cylinder length: 50–2500 mm
- Function principle of distance measuring system: magnetostriction, absolute, contact-free
- Measured variable: distance, position, speed
- Signal output: 0–10 V, 4–20 mA
- High degree of accuracy: ± 0.1 mm
- Protection type: IP 67

Function

The hydraulic cylinder with integrated distance measuring system combines tried-and-tested electronics with the enormous power density of hydraulic drives. The distance measuring transmitter (HLT 1000), which operates on the principle of magnetostriction, is combined with the hydraulic cylinder. Based on the non-contact and wear-free measuring system, the sensor has a pressure-resistant stainless steel housing for full integration into the cylinder. The external diameter of the cylinder remains unchanged and, when equipped with the integrated distance measuring system, the total length of the cylinder is only marginally longer. Electrical connection is either via flying leads or a panel mount connector M12x1 on the foot of the cylinder. The result is a compact subsystem for continuous position monitoring of a hydraulic cylinder and is already in use for tailstock and steady rest adjustment in grinding machines.

Advantages

- **Reliable:** Not sensitive to ingress of external contamination
High degree of shock and vibration resistance
Wear-free due to non-contact measuring principle
- **Compact:** No disruptive structures,
no external measuring system required (all-in-one)
- **Clever:** Ready-to-operate unit, minimal installation costs (plug & play)

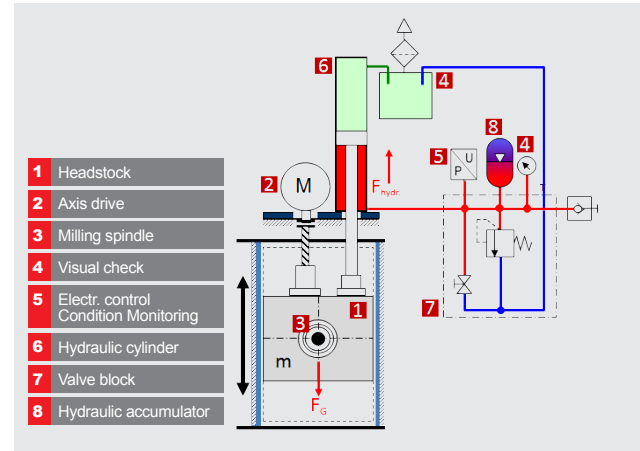

Hydraulic counterbalance

Features

- Counterbalance consists of cylinder, accumulator, control block + transparent reservoir
- Control block with valves for pressure relief, electrical monitoring and for filling
- Transparent reservoir + pressure gauge for visual check
- A breather filter prevents contamination at the piston end-cap side of the cylinder

Function





The function of the counterbalance is to relieve the mass force on the drive when a frame component (spindle carrier, cross-beam) moves vertically. In the standard design, it consists of a differential cylinder, where the annular side is connected to an accumulator. When the headstock is moved by the spindle drive, oil is discharged from the cylinder into the accumulator, or vice versa. The gas volume of the accumulator is compressed or expands in response to the movement.

In the standard accumulator model, the cylinder size, gas volume and gas pressure are selected so that the weight is 100% counterbalanced in the middle of the stroke. In the upper end position the accumulator pressure counterbalances up to 90%, in the lower end position up to 110%. Different adjustments (over-compensation, under-compensation, smaller or larger variations) can be made simply, according to customer requirements.

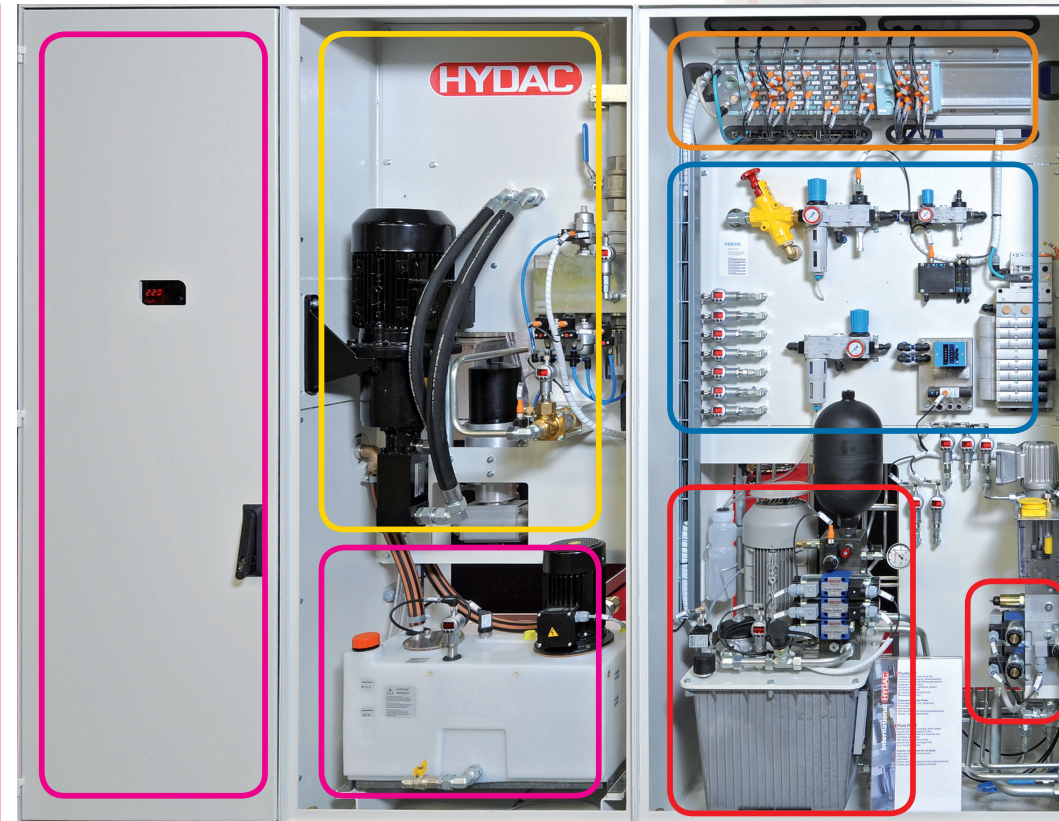
Advantages

- Reduction in drive power for lifting and lowering the headstock
- Reduction in spindle wear
- Bi-directional control behaviour
- The result is higher energy efficiency of the machine tool

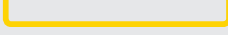
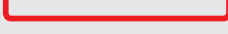

	Cooling	Air, water and/or refrigeration cooling system
	Electronics	Sensors, electrical control
	Cooling lubricant	CX valves, piston control valves, high pressure pump, automatic back-flushing filter
	Hydraulics	Hydraulic power unit, valve stacking systems and hydraulic accumulator units
	Pneumatics	Supply unit, valves, modules, etc.

Fluid panel

Function

A fluid panel is a self-supporting unit which combines all the fluid control components of a machine tool. It includes the cooling, electronics, cooling lubricant, hydraulics and pneumatics. By using defined interfaces accurately coordinated with the machine tool manufacturer, it is possible to design a subsystem to concentrate all the fluid control for a machine tool in one area. From the technical calculation, through installation including piping and wiring, right up to function testing the unit, HYDAC is your system partner with all the expertise.

Advantages

- Quick and simple installation through the use of defined hydraulic, pneumatic and electronic interfaces (quick release couplings, connectors, etc.)
- Concentration of all the fluid control within the machine → Clearer overview, improved maintenance, simpler error diagnostics
- Machine tool manufacturer has one contact for the different fields: cooling, electronics, cooling lubricant, hydraulics and pneumatics
- All from a single source - reduces the number of interfaces and minimises the suppliers

Trends & Innovations

Steadily increasing customer requirements, increasing energy and raw material costs and the natural quest for perfection are both our driving force and our motivation to innovate and develop new solutions. Ongoing collaboration with universities and institutes in dissertation work and research projects provides the ideal combination of theoretical and practical specialist knowledge. In accordance with this principle, HYDAC has been developing products for over five decades and has opened up new areas of operation and business sectors.

Business sectors

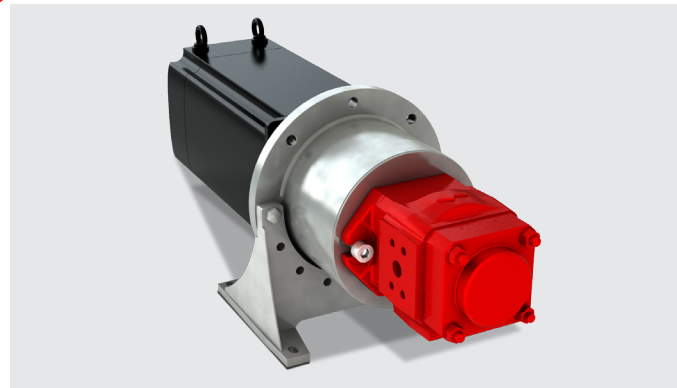

HYDAC KineSys – drive systems

KineSys stands for kinematic systems and are notable for their perfect symbiosis of hydraulic and electro-mechanical engineering. Customers increasingly require modern machines and systems which offer high productivity combined with efficient use of resources. The efficient design of the drive system is therefore an important factor when considering overall life cycle costs.

Using the experience gained from many international projects, our industry and product specialists will analyse your application. Depending on the application, different strategies are selected for the drive tasks, from a simple control right up to highly dynamic controls.

With access to the entire range of HYDAC products we can provide you with the best solution for your requirements. This streamlines the design and ensures maximum efficiency for the operation of your machine and system.



- Hydraulic side**
- High power density
 - Robustness
 - Simple overload limiting procedure
 - Simple linear movement implementation

- Electro-mechanical side**
- Simple controllability
 - Quiet
 - Simple integration into higher-level control
 - Energy efficiency



Advantages of KineSys products and solutions:

- Increases productivity
- Reduces noise emissions
- Longer service life of the components
- Streamlines the design
- Integrates safety functions

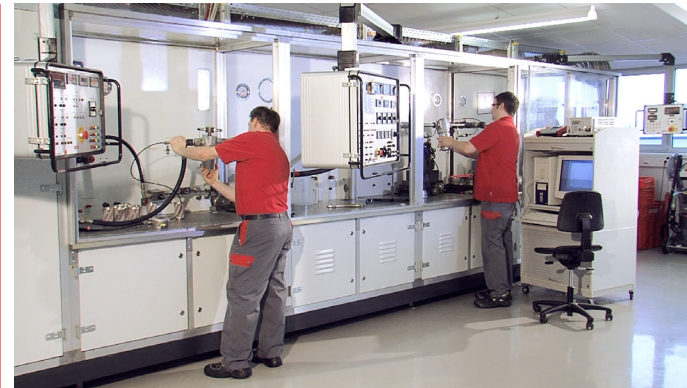

HYDAC FluidCareCenter

Only the best specialists in their fields of fluid filtration, filter systems, and process filtration are chosen for the HYDAC FluidCareCenter (FCC).

Our aim is always to find the best solution possible for our customers. This is why, at the FCC, we combine our forces to develop solutions tailored to our customers' specific needs. Although our main focus is on developments in the field of filtration, we also welcome projects that stretch beyond filtration concepts. At HYDAC you have access not only to the products, but also to specialists in all aspects of hydraulics "all under one roof".

The FluidCareCenter, the only facility of its kind in the world, is a research and development centre covering an area of over 2400 m². It is equipped with cutting-edge laboratory and testing equipment, making it possible to perform every conceivable filter performance test and fluid analysis. Practically any application situation can be simulated.

Advantages

- By understanding the relevant cleanliness data of your components, you will be a step ahead of your competitors
- A laboratory approved and recommended by well-known automotive suppliers
- Many years' experience in the area of technical cleanliness owing to active collaboration on VDA Volume 19 and ISO 16232
- Analysis with the help of extraction units developed at HYDAC
- Sophisticated analysis equipment
- Ongoing continual development of equipment and processes to meet the increasing requirements and needs of customers



Product innovations

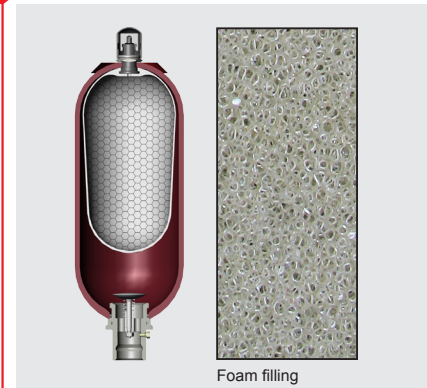

HYDAC bladder accumulators with foam-filled bladder

Features

Bladder accumulators are hydropneumatic accumulators with a flexible elastomer bladder acting as the separating element between the compressible gas cushion and the operating fluid.

From the outside, the bladder accumulator with a foam-filled elastomer bladder looks no different to the normal accumulator. The core of the accumulator, the accumulator bladder, not only makes use of the compressibility of the gas to store energy, but is further aided by the foam filling. Depending on the nominal size of the accumulator and the application, this can increase the energy capable of being stored by approx. 30 % (in extreme cases up to 70 %).

This means that for the same energy requirement, a smaller nominal volume can be used.

Advantages

- High heat capacity on the gas side
 - Low rise in temperature during highly dynamic charging and discharging processes
- Good insulation effect of the foam to the oil
 - Reduction of the heat exchange with the environment corresponds to improved efficiency
- High degree of elastic recovery of the foam in the bladder
 - Residual volume reduced by half



HYDAC Stat-Free® elements against electrostatic charging in the system

Features

Over the past few years, the trend towards ash-free hydraulic fluids, more compact systems and finer filtration has led to increasing problems of electrostatic charging in hydraulic and lubrication oil systems.

With the innovative Stat-Free® filter elements, HYDAC has succeeded in combining excellent electrostatic characteristics with filtration performance.

In the new application-specific Optimicron® Power and Optimicron® Pulse series, the Stat-Free® technology is included as standard. All the other series, such as Optimicron®, ECOmicron®, etc., can be provided with Stat-Free® as an option.

Advantages

- Unprecedentedly low charging of the filter element and the fluid
- Prevents damage, such as:
 - Explosions in the tank
 - Accelerated oil ageing
 - Damage to the filter element
 - Destruction of electronic components
- Longer oil change intervals can be achieved because filtration of the oil is non-damaging
- Enormous cost savings due to less frequent oil change, filter element change and system failure
- Optimised mesh pack design



HYDAC sensors with IO link interface

Features

Due to increasing demand for IO link products HYDAC Electronic has again expanded the IO link range. HYDAC's well-known 3000 family with integrated digital display now includes products for pressure, temperature, fluid level and oil humidity.

The products with IO link communication interface according to specification V1.1.2 are particularly suitable for integration in automation systems.

Compared with the standard version, the IO link interface enables bidirectional communication between the device and the control. Parameterisation and cyclical transmission of process and service data is therefore possible.

Typical fields of application are machine tools, handling and assembly automation, intralogistics or the packaging industry.

Advantages

- IO link interface or PNP transistor switching output
- 1 additional signal output configurable as PNP transistor switching output or analogue output
- Parameterisation and a cyclical transmission of process and service data
- Simplifies installation and commissioning
- Reduced maintenance time and effort