



SMART MILLING.

INSTANT PRODUCTIVITY.

SMART MILLING



reddot award 2016
winner industrial design

reddot award 2016
winner interface design

Product video.



More information:
datron-neo.com/videos

DATRON neo was specifically designed and purpose-built to give you an easy access to high-speed milling. This Plug-and-Play system features the new DATRON next software which gives you full control of 3-axis milling without requiring years of experience as a machinist. Ergonomic, frontal access to the work area allows for quick and safe setup of workpieces, resulting in rapid and precise machining. All of this and DATRON neo actually fits through a standard door.



AT-A-GLANCE.

Revolutionary control system

P.12

Technical highlights and machine data

P.17



More Information: datron-neo.com/neo

DATRON neo MAKES THINGS EASY (FOR EVERYBODY).



Small Scale Production:
Smartphone



Exclusive design for those who want to stand out in a crowd.

"With my DATRON neo, I quickly turn product design ideas into custom prototypes. The quality of this Smartphone part amazed even my toughest critic ... me!"

P.03



Design Model:
Wrist Watch



Product ideas come to life right down to the last detail as a sample part.

"Right away, materials mill with the same mirror finish I'd expect in a production part. This couldn't be done easily or quickly without DATRON neo."

P.05

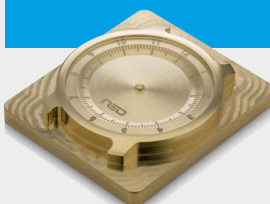

Prototypes:
Work Pieces in Plastic



When 3D printing just does not make sense.

"Originally I thought that 3D printing was the solution for everything. Now I know that the DATRON neo helps do prototyping jobs much more flexibly and at a much lower cost."

P.07



More Information: datron-neo.com/lab



Smartphone Housing



"Good ideas don't always transform into real parts overnight, but with neo they're here in a fraction of the time."





DYNAMIC.

FLEXIBILITY FOR SHORT RUNS

The DATRON neo provides high dynamics in machining aluminium – especially when a high surface finish is required. In industries with large and small batch production i.e. the electronics industry, bigger conventional machines are only cost effective when they are cranking out serial production parts in high-volume runs. DATRON neo is an ideal compliment to that equipment, because it adds the flexibility to machine prototypes or short runs of small parts, leaving those larger machines to do what they do best.

A further plus of the DATRON neo is its comprehensive capability to tackle a range of milling strategies without the need for post processing. From pocketing and chamfering to drilling and thread milling, DATRON neo gives you full control.

For this smartphone case (below), the DATRON neo equipped with a vacuum chuck met the following challenges:

- > Dynamic milling of solid stock
- > Intricate detail and complex structures
- > Exceptional surface quality
- > Precise thin-walled geometries



Intricate pins and bars

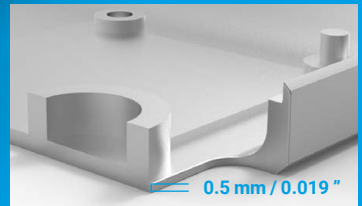

Thin-walled areas



Exceptional surface quality



Engraving on curved surfaces

Watch the application video



More information:
datron-neo.com/phone

ATTENTION TO DETAIL.

TURN YOUR IDEAS INTO REALITY

The machining of non-ferrous metals is one of the key strengths of the DATRON neo. After the work-piece has been machined from solid stock, DATRON neo produces free-form structures with a consistent surface finish. Using small tools, the 3-axis milling machine produces even the most intricate engraving details with superb quality.

DATRON neo equipped with a jaw chuck shows its dynamic capability with this complex design model of a brass wrist watch (below):

- > Precision machining of brass
- > Intricate surface geometries
- > Realistic representation of the design idea



Smooth and precise 3D surfaces



Intricate engraving using small tools

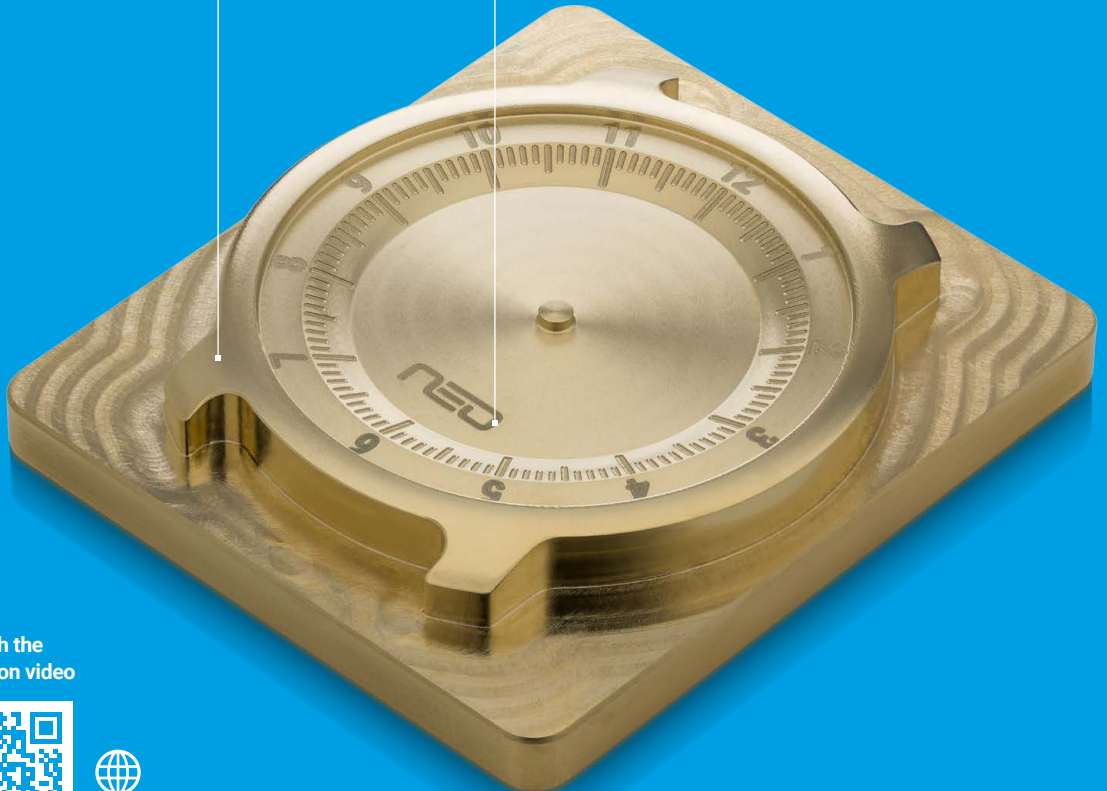

Watch the
application video



More information:
datron-neo.com/watch



Design Model:
Wrist Watch



“DATRON neo produces
mirror-like edge finishes
and detailed engraving ...
even on rounded surfaces!”

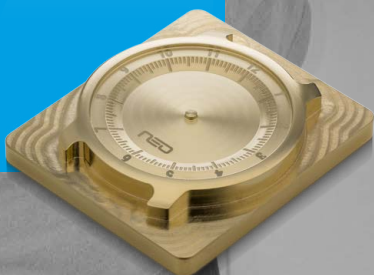

Prototyping



"Prototypes are one of the major challenges in everyday milling. The versatility of the DATRON neo is proven by its ability to handle a variety of materials with high-quality results."

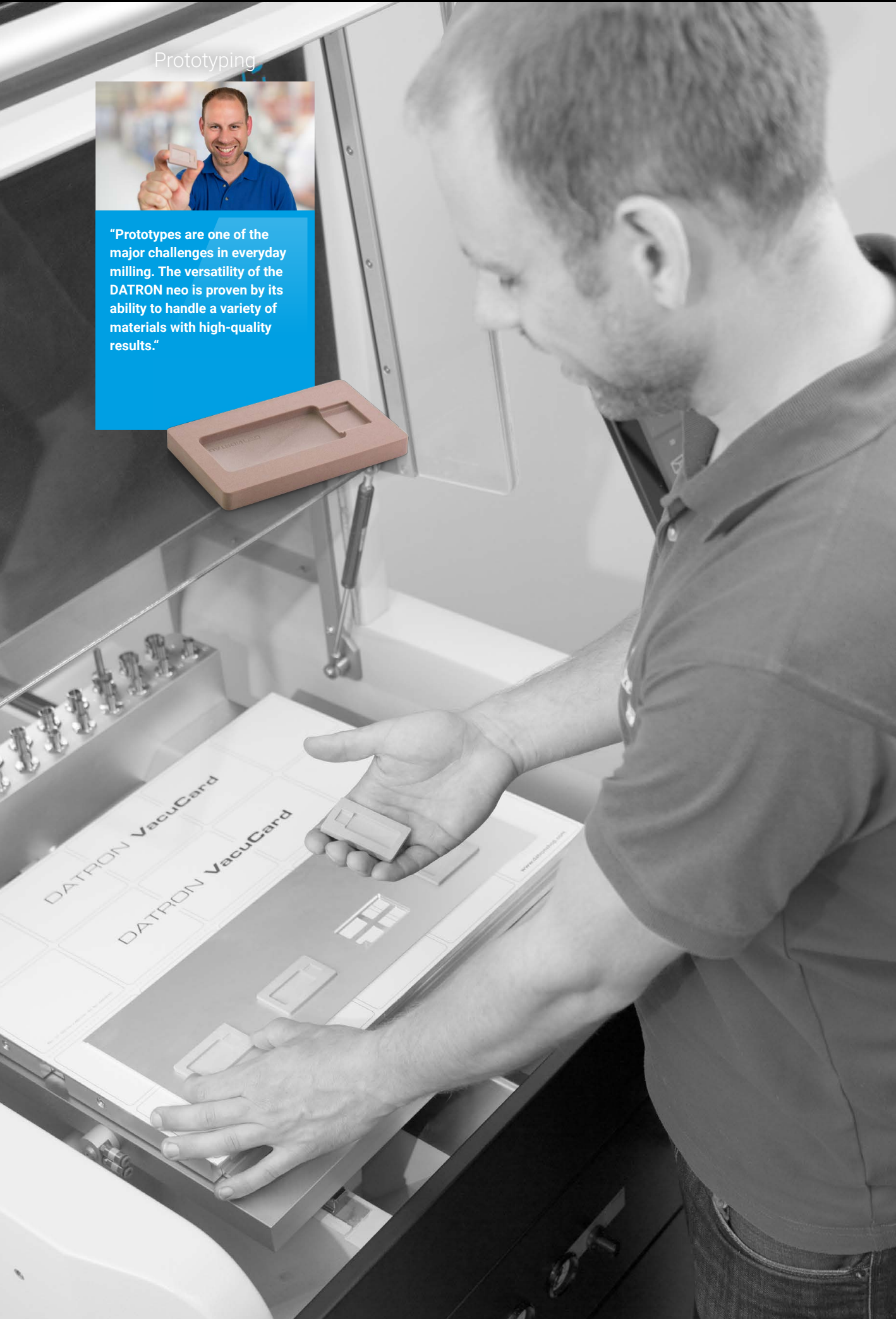



FLEXIBLE.

IDEAL FOR A VARIETY OF MATERIALS

With DATRON neo, milling is easy and efficient. Milling strategies like pocketing, chamfering, thread milling and creating 3D forms can all be performed quickly using this 3-axis compact milling machine. Prototypes made of composites, engineered plastics, metal or wood are produced quickly and with a consistently high quality.

DATRON neo equipped with a vacuum chuck shows its flexibility in these examples of prototype parts made of PU foam, acrylic and CFRP (below). This includes:

- > Milling of challenging and abrasive materials
- > Glass-like curved surface on acrylic
- > No need for post-processing
- > Optional dust extraction for a clean machine interior



Precise 3D and flat surfaces



Contours, holes and pockets in CFRP without burring or fraying



High-gloss 3D and plane surfaces, as well as outer contours

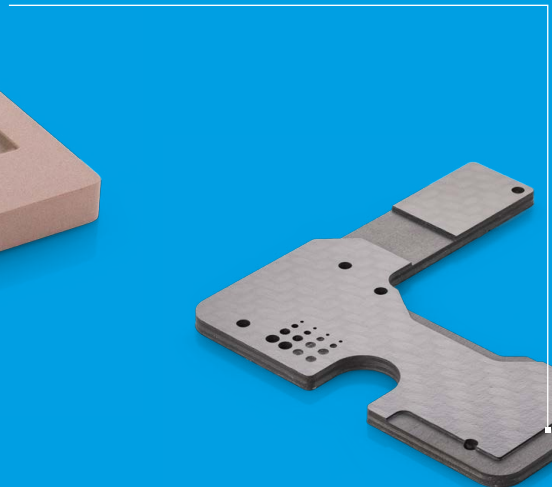

Watch the application video



More information:
datron-neo.com/prototype

FROM YOUR SKETCH TO THE FINISHED WORKPIECE.



It all starts with your idea.

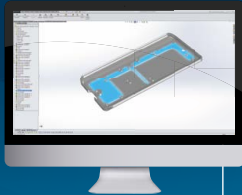
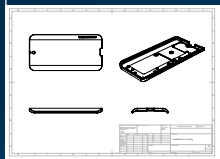

CAD

You design your component in 3D.*



CAM

Using CAM software, you select a milling strategy for your design.*

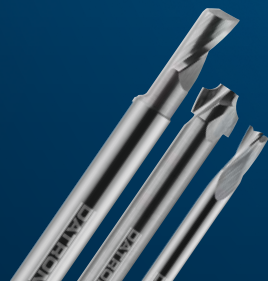

Accessories and consumables

Expand the flexibility of your DATRON neo with matching accessories and consumables.

P.19/P.25



Customer care and service

You need maintenance, training or other services?

We've got you covered!

P.25

* We'll consult you on available software packages as well as on training.



DATRON next

With this future-oriented control system, we make milling easy for beginners and professionals. Simply control DATRON neo with familiar swipe gestures you use on your smartphone.

P.11



DATRON neo

A compact, easy to use 3-axis milling machine, which has it all: Flexibility, dynamics, performance and quality – all housed in the smallest possible space.

P.17



Even complex machining parameters are easily programmed.

Thin-walled contours and intricate drill holes, with no need of post-processing.





DATRON next.

MAKES MILLING AS EASY AS 3D PRINTING



EVERYTHING AT-A-GLANCE!

- > Tile design with self-explanatory icons
- > Realistic 3D graphics
- > Current machine status is visible on the run screen even from a distance

EASY HANDLING!

- > Intuitive touch operation, similar to a smartphone
- > Camera-assisted setup using swipe gestures
- > App-based functions

PRODUCE YOUR IDEAS QUICKLY!

- > Fast, simple process
- > Just 4 steps to the finished workpiece
- > Compatible with leading CAM suppliers



DATRONnext.

4 STEPS TO THE FINISHED COMPONENT



The DATRON next CAM Wizard provides ultimate ease of use, because it supports you in all aspects of preparing the milling operation. In just 4 steps, the CAM Wizard takes you through the program and tool management, assists in workpiece setup and enables workpiece simulation.

1 SELECT AND LOAD

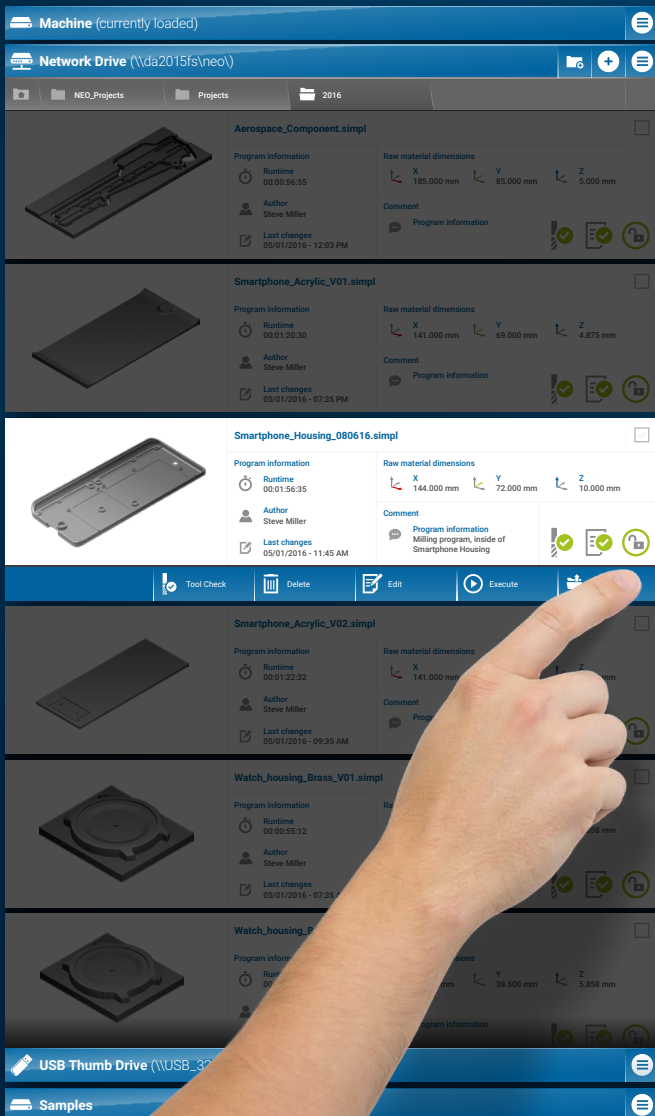

Program management



With the DATRON next program management system, you load the milling program provided by your CAM system via a network or a USB device.

The DATRON next program management system visualizes the data of each existing component, allowing you to quickly select and load a component.



2 FAST TOOL SETUP



With the DATRON next tool management functionality everything about tools is handled. The system gives you detailed information about the specific type, the diameter, the flute length and where the tool is located.

The DATRON next filter function allows you to find a specific tool within seconds. The tool management stores all information on DATRON tools, eliminating time-consuming manual tool data entry.

AUTO-CHECK

The special tool-check function checks all tools (predetermined by the CAM system) and compares them to those already existing in DATRON neo.

So, you get a quick overview of the tools available and those still required – with appropriate suggestions for alternatives.



⚠ Not available
☰

👉 Tool Storage (manual change)
☰

✔ Tool Magazine
+
☰

156

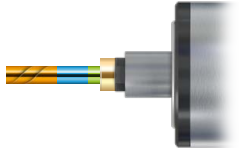

∅ 6.000 mm

Single Flute End Mill

Description

Comments

Supplier
DATRON AG

Article number
0068960L

Flute			Toric Cut		Shank		Length	
∅	mm	Z	∅	mm	mm	∅	mm	
6 mm	20 mm	1 mm	6 mm	20 mm	8 mm	0 mm	60 mm	

3 QUICK MEASURING WITH CAMERA AND SWIPE GESTURES



Smartphone Housing - Workpiece Coordination System Save

Axis Position		Remaining
X	258.152	12.922
Y	123.265	56.325
Z	15.700	143.525
A	0.000	0.000

Vacuum Suction

XYZ Sensor Safety Positioning

Absolute Linear Movement Incremental Linear Movement

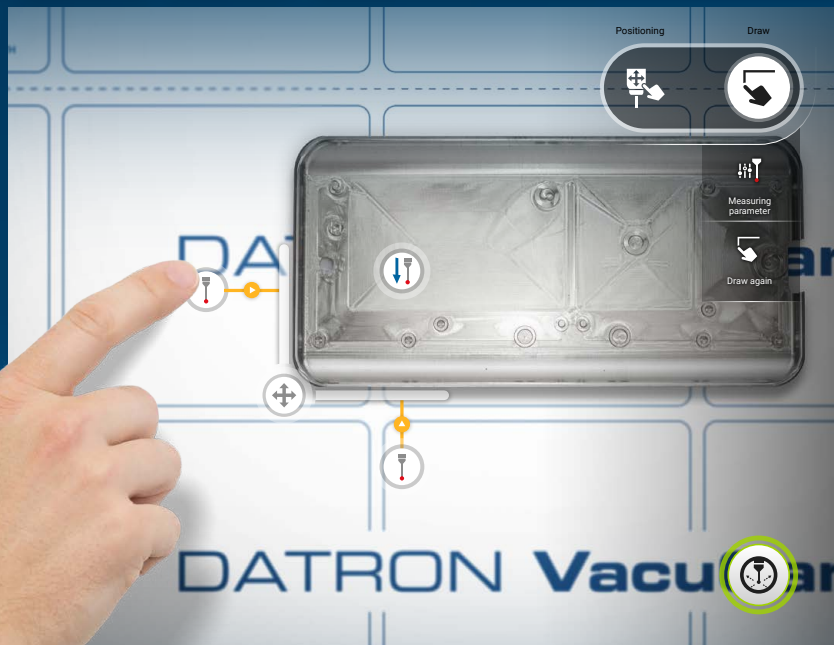

REVOLUTIONARY & EASY: SETUP OF COMPONENTS



The correct setup of the workpiece, including establishing a zero point for orientation in the machining area, is one of the basic requirements for excellent machining results.

DATRON next supports your setup by combining swipe gestures with an interior camera and a 3D probe. Even without any previous milling experience, you can intuitively set up your workpiece perfectly.

In addition, classic, figure-based measurement cycles are available, that are easy to operate using intuitive graphics.



4 3D SIMULATION OF THE MILLING PROCESS

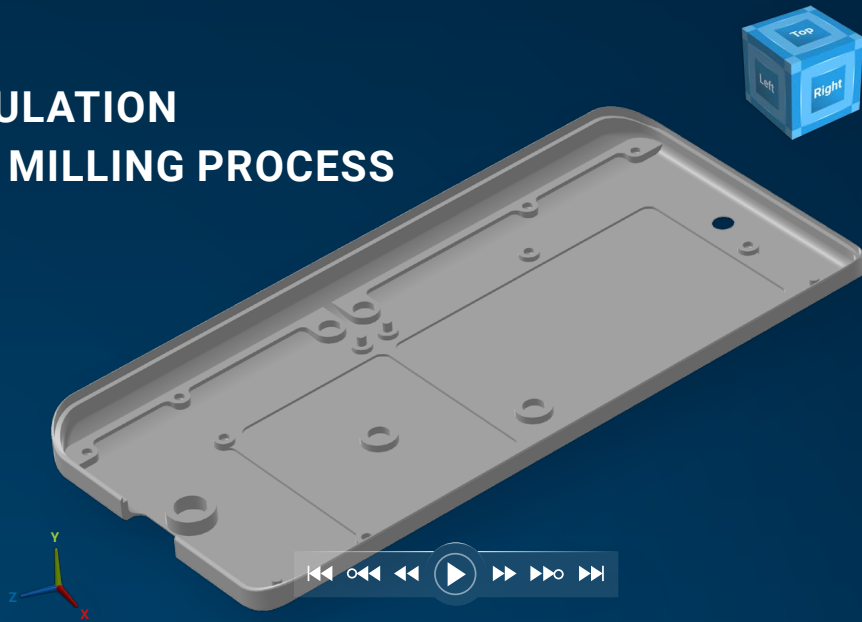

By means of the DATRON next simulation, the paths of the milling process can be calculated, taking into account the tools that are already assigned in the machine. Finally, the workpiece is visualized in 3D. You can now preview the entire machining process in the simulation and check in advance whether the desired milling result is achieved. You can zoom, rotate and push the virtual workpiece around with your fingertips at will.

RUN SCREEN: EVERYTHING UNDER CONTROL

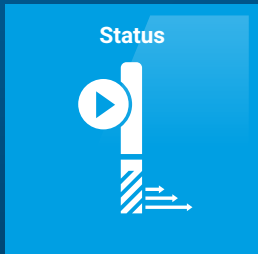

The run screen (Status) shows all relevant information at a glance. The program's progress, the calculated time remaining and the machine status are visible even from a distance.

Smartphone_Housing_161216.smp1

⏪ 00:59:24
⏸ 01:56:35

 Positioning feed 3500 mm/min	 Axis position	Remaining path X 10.224 10.202 Y -11.865 -15.775 Z -3.250 2.256 A 0.000 0.000
 Spindle load 80% 40.000 min ⁻¹	#213 Single Flute End Mill 	
Roughing: 8 mm/min Finishing: 10 mm/min Plunging: 8 mm/min Ramp: 8 mm/min Approach: 8 mm/min	Description: The patented ball-nose single flute end mill – an exclusive DATRON product. Powerful, economical and highly efficient. Comment: Article number: 0068088E Supplier: DATRON AG Flute: Ø 8 mm	
Comment Spindle RPM Comment Feed rate Comment Speed rate Comment Text	Vacuum: -0.84 bar Cooling lubricant:	

START RIGHT AWAY.

“PLUG & MILL”: VALUE FOR MONEY



24-station tool magazine with integrated tool-length sensor

For high flexibility and precision

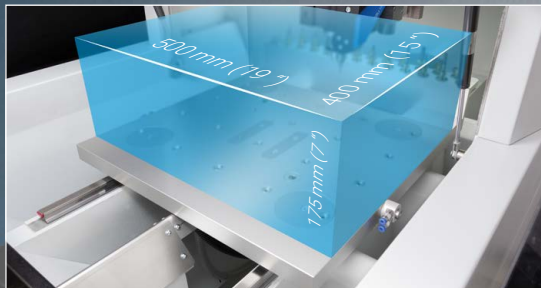

Ergonomic frontal access to the work area

For quick and safe setup

Traverse paths (X/Y): 500 mm / 400 mm (19" x 15")

Gantry passage: 175 mm (7")

DATRON neo was engineered to be installed easily by yourself.

With DATRON neo you receive a high performance out-of-the-box system that contains numerous hardware and software highlights. The 24" multi-touch

operating display, the 3D probe (XYZ sensor), the integrated (machining area) camera, the 24-tool magazine and the 2 kW spindle with minimum-quantity coolant system – all allow you to perform fast, high-quality machining results from day 1.



3D probe (XYZ sensor) and camera

For easy setup



2 kW spindle and minimum-quantity coolant system

For burr and residue free components*



24" multi-touch display

For innovative operation



* If using ethanol coolant



CLAMP ANYTHING.

VACUUM PLATES

DATRON vacuum module clamping plates offer maximum clamping force and ease of use, achieved by special DATRON vacuum distribution. Two vacuum plates specifically designed for DATRON neo are operated separately via connectors recessed in the machining table. Each plate is subdivided into 10 segments that, depending on component size, can be activated individually.

To distribute the vacuum optimally below the workpiece, we have developed the DATRON VacuCard, a special cardboard, that serves as a sacrificial layer.

Vacuum plates

For easy clamping of sheet materials





Dust extraction

For dust-free working

FOR A CLEAN WORKING ENVIRONMENT.

DUST EXTRACTION

The fine dust generated when machining plastics or wood is removed efficiently with the optional DATRON neo dust extraction.



SPEED CLAMPING.

SHORT-STROKE ELEMENTS AND T-SLOT PLATES

The pneumatic-clamping system moves with the click of a button to ensure quick job setup and changeover. According to your needs, you can use it on a T-slot plate or in stationary manner.

Short-stroke clamping element

For fast and flexible clamping

T-slot

For easy positioning of accessories





FULL FLEXIBILITY.

NUMEROUS POSSIBILITIES

Whether your application calls for centric clamps, jaw chucks, or rotating axes, DATRON neo provides full flexibility to integrate them. The possibilities for clamping workpieces are as varied as your projects and applications. Tapered bores with threaded inserts in 100mm pitch allow fast, accurate and repeatable workholding using different clamping technologies.

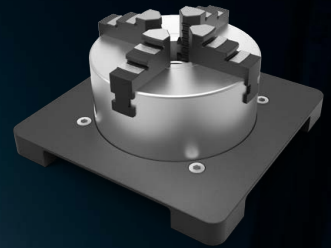

Jaw chucks

Centric clamping of components

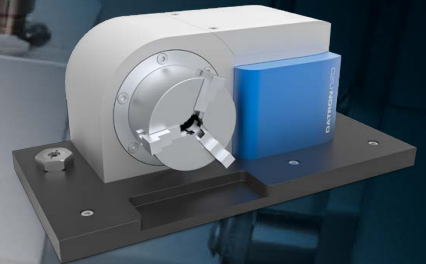

Rotating axis

Precise multi-side machining of workpieces



Centric clamps

Secure clamping of small parts



Tapered bores with threaded inserts

For precise repeatability

Integrated compressed air outlet

For connecting accessories easily



MACHINE FEATURES

Machine features

Machine construction	Gantry design, machine frame made of polymer concrete casting, aluminium table
Drive system	brushless, digital servo drives; direct drive ball screws for each axis
Floor space without operating terminal (W x D x H)	805 mm x 1,290 mm x 1,880 mm (32 " x 51 " x 74 ")
Weight	approx. 700 kg (1,543 lbs.)

Machining features

Traverse path (X x Y x Z)	520 mm x 420 mm x 220 mm (20 " x 16.5 " x 9 ")
Machining area (X x Y)	500 mm x 400 mm (19.5 " x 16 ")
Gantry height	175 mm (7 ")
Machining speed	up to 28 m/min (1,102"/min)

Equipment/Scope of delivery

High-frequency machining spindle	2 kW up to 40,000 rpm
Tool magazine with tool-length sensor	24-fold with direct shank tool holder
Minimum quantity cooling system	✓
Operator terminal	24" multi-touch display
Comfortable hand held control unit	✓
Control system/Software	DATRON next
3D probe	✓

Supply

Tension	3 x 400 VAC/16A
Power input	3.5 kW
Air supply	7 – 10 bar (100 psi), dry, clean, oil-free
Ambient temperature	18 – 30 °C (65°F – 86°F)

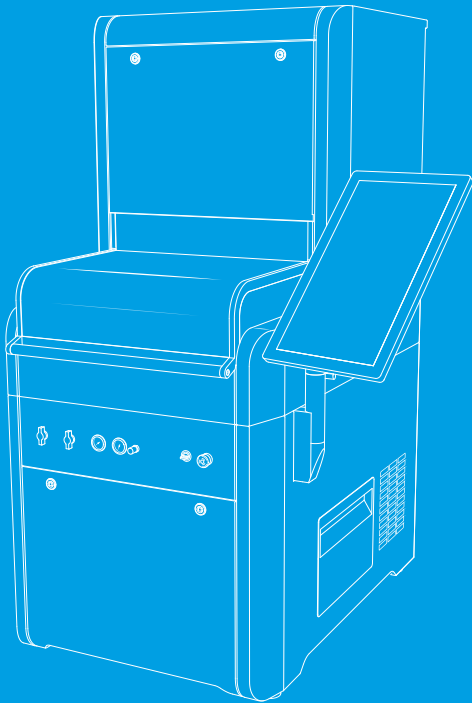

AT THE READY

Unpacking, commissioning and setting-up the DATRON neo is so simple that you can do it all by yourself. All you need is a standard pallet truck.

Watch the application video



More information:
datron-neo.com/start-up

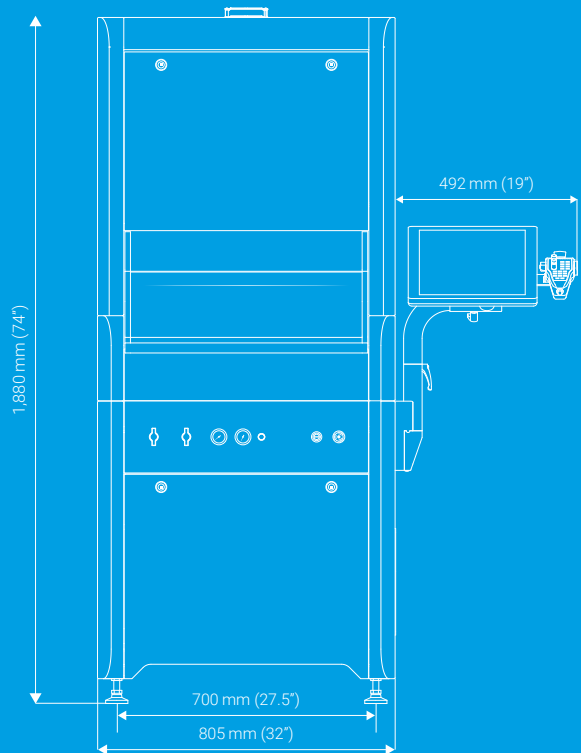
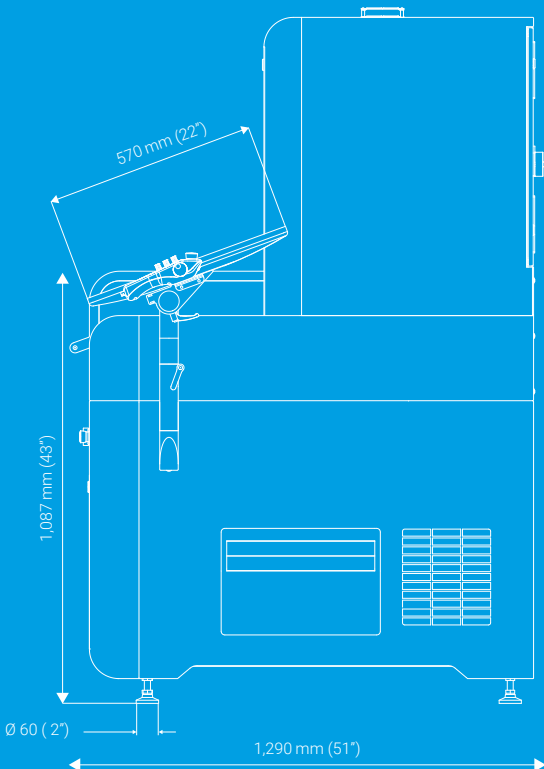

SPACE-SAVING

DATRON neo is extremely space-saving. It fits through all standard doors and uses only 1 square meter of your production space.

STABLE

The aluminium table on a machine frame made with a solid polymer concrete casting ensures stable and low-vibration machining. Using DATRON neo you achieve workpieces with consistent surfaces and precise milling details.

EASY ALL-AROUND.

CONFIGURATION



Everything about the DATRON neo is easy, even the machine configuration. Select accessories for our out-of-the-box milling solution online, by simply following the QR code.

To the machine
configurator



More Information:
datron-neo.com/config

ONLINE SHOPPING: TOOLS & CONSUMABLES



The design and the quality of cutting tools largely determine the cost effectiveness and quality of CNC machining. Due to years of experience and the constant dialogue with our customers, DATRON provides fast and high-quality tooling solutions for optimal machining. Ask your local DATRON sales partner for details.



More Information: tools.datron.de

AFTER SALES AND SERVICE OFFER



DATRON stands for highest quality and flexibility. Our international partners offer individual after sales services from installation and setup to maintenance and support for years to come. Contact your local DATRON sales partner for further information.

To the
service packages



More Information:
datron-neo.com/service

Everything from a single source: DATRON.

DATRON
Smart Manufacturing Solutions

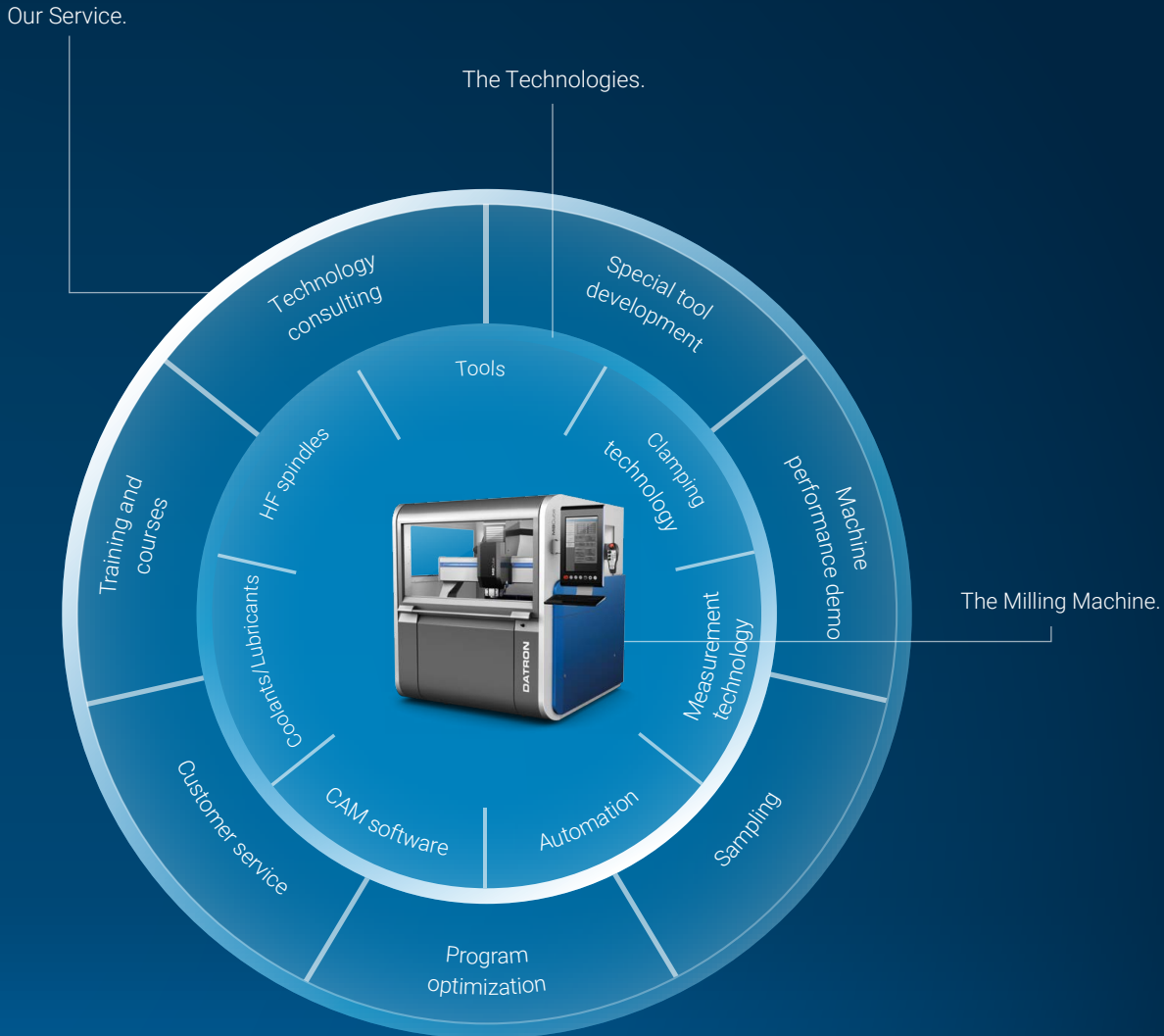

WITH DATRON YOU'RE IN EXPERT HANDS.

MORE THAN JUST MACHINE ENGINEERING

At DATRON we consider ourselves to be your partner for successful production. Our service: Everything from a single source. DATRON not only offers cutting-edge machine engineering with "Made in Germany" durability and reliability, we also accompany you through the entire workflow from technical advice during the sales process to optimal maintenance and repair services, including training and tips for energy- and cost-saving production.



More information: www.datron.de

www.datron-neo.com



DATRON AG
In den Gänsäckern 5
64367 Mühlital, Germany

Phone: 0 61 51 - 14 19 - 0
Fax: 0 61 51 - 14 19 - 690
www.datron.de

Please see our "safety rules to operate the machine". They can be requested from DATRON or viewed at www.safety.datron.de.

The information in this brochure contains current descriptions or performance features which are subject to change due to further development of the products. Some product images might include optional components. The descriptions and performance features are binding only if they are expressly agreed in writing at the time of conclusion of the contract.

All content in this brochure is the property of DATRON AG or its licensors and is subject to intellectual and industrial property rights of the copyright holders. If you copy this content, print it or make it in any form available, you agree to recognize all trademarks, copyrights and other proprietary rights. You further agree not to edit aforementioned content. With the exception of aforesaid limited right of use DATRON AG does not grant you any explicit or implicit rights or licences under any trademark, copyright or other rights in relation to intellectual or industrial property. DATRON, DATRON neo and DATRON next are registered trademarks of DATRON AG. DATRON neo is a registered design patent.

© 2016 DATRON AG. All rights reserved.