

MORSE[®]

PRODUCT CATALOG

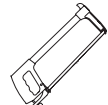

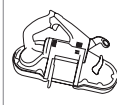
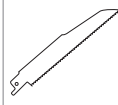
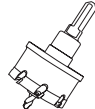
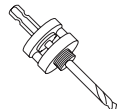
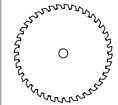
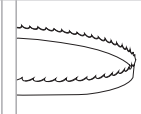
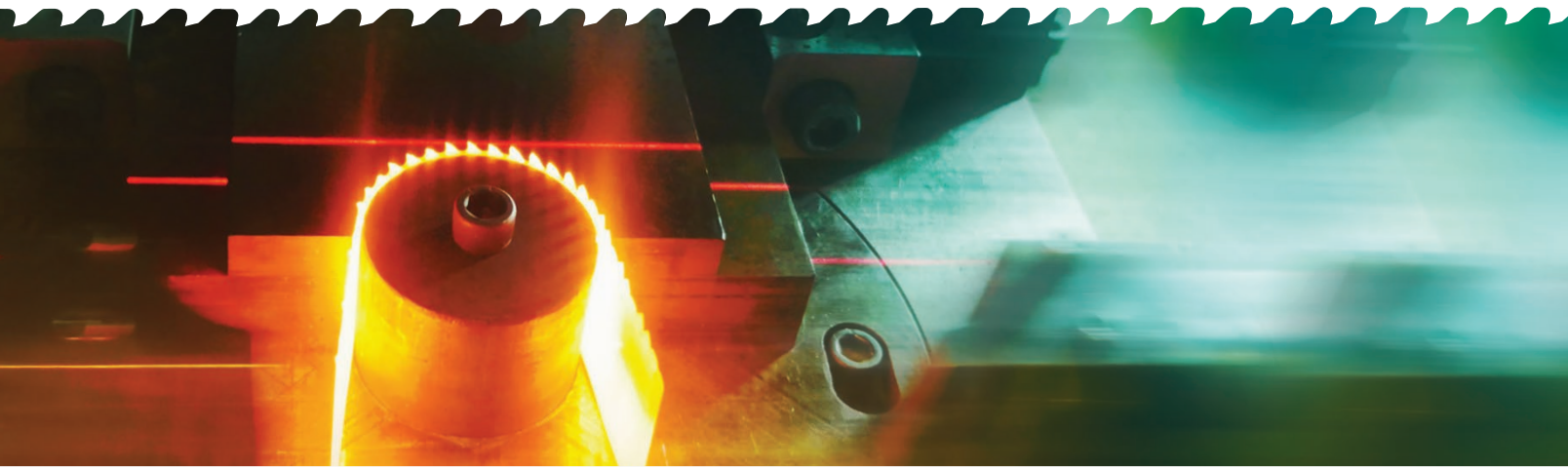
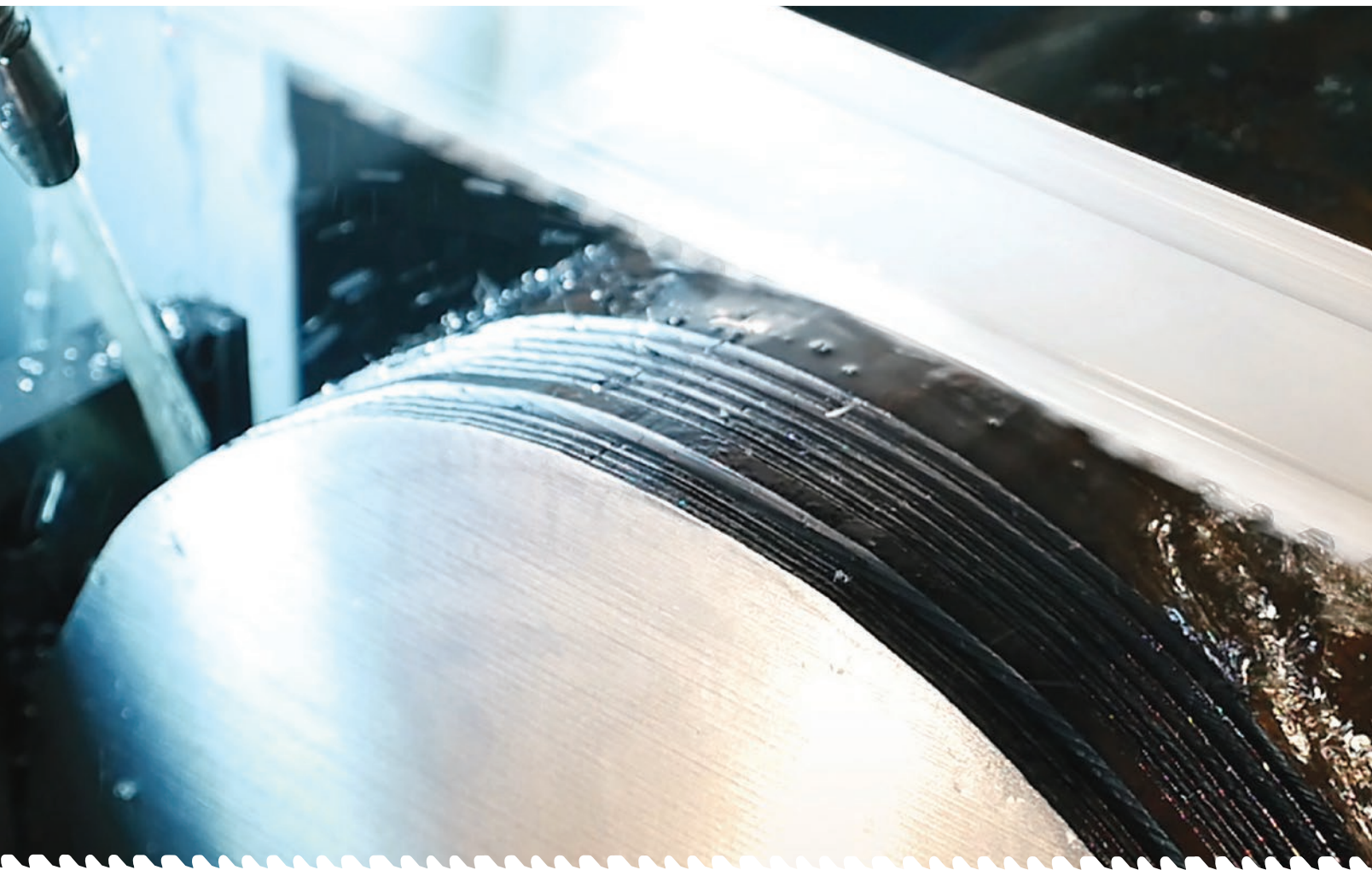

MORSE[®]



TABLE OF CONTENTS

Industrial Products

Cutting Technologies	5
Band Saw Blades	8
Blade Selection	9
Metal	
Carbide Tipped	
Jawbreaker	10
M-Factor	11
Bi-Metal	
Independence	12
Maverick	15
The Morse Achiever	16
Challenger	17
M42	18
Matrix II	20
Bi-Metal Die	21
Wood	
Carbide Tipped	
Quiksilver CT	23
Bi-Metal	
Quiksilver B1/B2	24
Carbon	
Quiksilver HEF/HB Wood Mill	25
Quiksilver Furniture Blades	26
Quiksilver HB	27
Quiksilver HEF	28
Specialty	
Carbide Grit	22
Pallet Dismantling	29
Band Saw Blade Information	
Blade Part Numbers	30
Tooth Selection Guide	31
Guaranteed Trial Program	32
Band Saw Machine Accessories	32
Cut Time Calculator	33
Blade Speed/Removal Rates	34
Blade Problem Solving	36
Blade Optimization	38
Anatomy of a Saw Blade	39
Tooth Set Specifications	40
Band Saw Tooth Pitches	41
Blade Recommendation Checklist	42
Thin Kerf Circular Saw Blades	43
Metal	
Revolution	45
Thin Kerf Circular Saw Blade Information	
Blade Selection	47
Operating Parameters	47
Blade Problem Solving	48

Power Tool Accessories

Hole Cutting and Boring	
Hole Saws	
General Purpose	
Bi-Metal	50
Arbors and Accessories	52
Carbide Tipped	54
Specialty	
Diamond Grit	55
Carbide Grit	56
Recessed Lighting	57
Kits	58
Hole Saw Information	
Operating Parameters	60
Pipe Tapping	61
Pipe Entrance	61
Precision Hole Cutting	
Metal	
Carbide Tipped Hole Cutters	62
Step Drills	64
Wood Hole Cutting	
Auger Bits	65
Spade Bits	66
Reciprocating Saw Blades	67
General Purpose	
Carbide Tipped	68
Bi-Metal	69
Metal	
Bi-Metal	70
Wood	
Bi-Metal	73
Specialty	
Demolition	74
Automotive	76
Safety	78
Drywall and Plaster	79
Pallet	80
Grit	81
Kits	82
Air Saw Blades	83
Metal Cutting Circular Saws & Blades	85
Blades	86
Saws & Accessories	88
Portable Band Saw Blades	90
Hand Saws, Blades & Accessories	94
Warranty Information & Warnings	98
Warehouse Locations	99



THE M. K. MORSE COMPANY



OUR HERITAGE

For more than 50 years, The M. K. Morse Company has been manufacturing and marketing a wide range of innovative cutting solutions. Our product performance is state of the art, but it's our unmatched service that makes us your best source for saw blades.

Whether you need to drill holes, cut metal using power tools, or saw metal in a factory, Morse has the right blade for the job. And our team of experienced field technicians can help you get the most from our blades on your equipment.

Available in more than 70 countries, nearly all Morse products are manufactured in Canton, OH, USA. Together with our distribution partners and weld centers, we make sure that customers get the right product when they need it.

As a second-generation family-owned business, we take pride in providing solutions for our customers. Our team is focused on saw blades, and we work relentlessly to improve the design, manufacture, service, and support for these products. Our primary goal is to succeed together, with you, our valued customers.

NOT ALL BLADES ARE CREATED EQUAL

At Morse, we are inspired by the belief that there is always a better way to cut. Our team of researchers, including engineers and material scientists, is the best in the industry. They create and translate innovative ideas into advantaged solutions that deliver the best value for our customers. We apply the same discipline to improve the precision and efficiency of our manufacturing processes so we can deliver the consistency and reliability our customers demand.

We proudly support our customers, from steel service centers and forging operations to contractors, fabricators, plumbers, and electricians. And the innovations we create for one application provide insights that help us improve others. We accept the challenge to get better every day.

EXPERIENCE THE MORSE DIFFERENCE

Innovative products are great, but they don't do you any good if you can't get them when you need them. Recognized for the highest levels of service in the industry, you can count on Morse to deliver. Offering next day/2-day shipment for weld-to-length band saw blades and same day/next day shipment for power tool accessories, Morse consistently delivers more than 98% on-time and complete.

We also understand that the more you know about sawing and saw blades, the better we can work together. We have developed and refined product-specific training programs that help our customers succeed. We regularly host groups from around the world for immersive, hands-on experiences. Participants walk away with the knowledge, tools, and confidence they need for success.

Plus, technical support is available from Morse when and where you need it. On-site support is provided through regional technical experts in North America, Europe, and Asia. And our phone support team is housed at our headquarters in Canton, OH.

If you've been a Morse customer for some time, we thank you for your business. If you're considering Morse, we look forward to working together with you to get the most out of your cutting operations.

Thank you for the opportunity to serve you. And happy sawing!



CUTTING TECHNOLOGIES

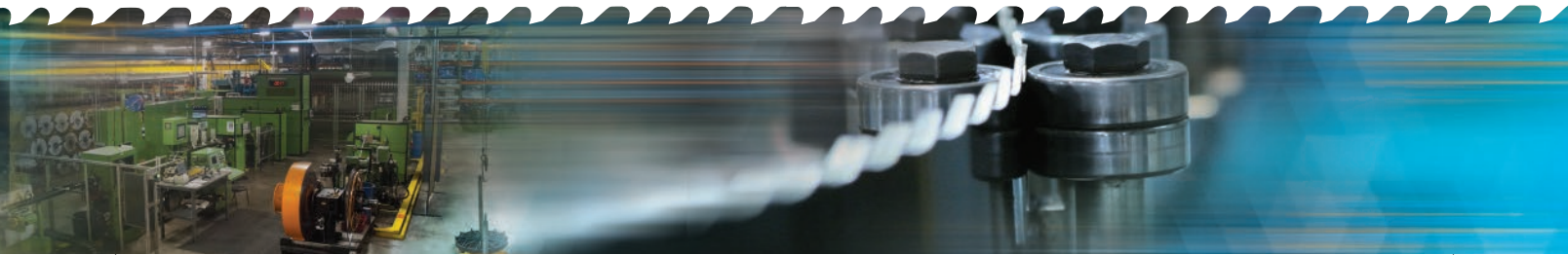

At Morse, we believe there is always a better way to cut. We are committed to consistently offer leading-edge solutions to our customers. Our research team is focused on cutting improvements, with benefits that extend beyond the blade.



Cutting forces are generated from the cutting motion of the blade (x axis), the rate of the feed (y axis) and the side-to-side action of the teeth within the cut (z axis). Blades with Morse Z Balance® Technology eliminate the side forces in the z axis. The effect is a straighter cut and reduced heat and wear, resulting in longer blade life. You can see the difference by the smaller chips produced by Revolution FS blades.

**Up to 30%
Longer Blade Life**

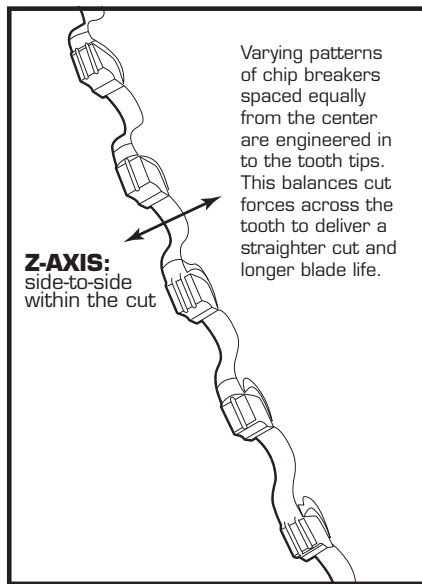

X-AXIS:
blade rotation

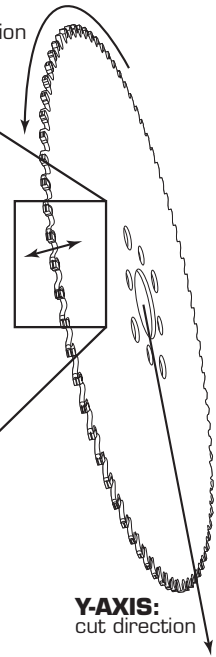

Morse Z Balance Technology is featured on: **REVOLUTION FS**



Most band saw blades create the kerf by bending the teeth side to side. Premature tooth wear can result as the bend relaxes through the life of the blade. With dual-patented KerfLock® technology, the teeth are not bent. The kerf is created by precision grinding the tips to a tolerance twice as tight as those used for set tooth blades. This results in a constant kerf that minimizes side-to-side forces, reducing tooth wear and extending blade life. It also prevents pinching that can occur as the blade moves through the material.

Up to 25% Longer Blade Life

Morse Kerflock Technology is featured on:

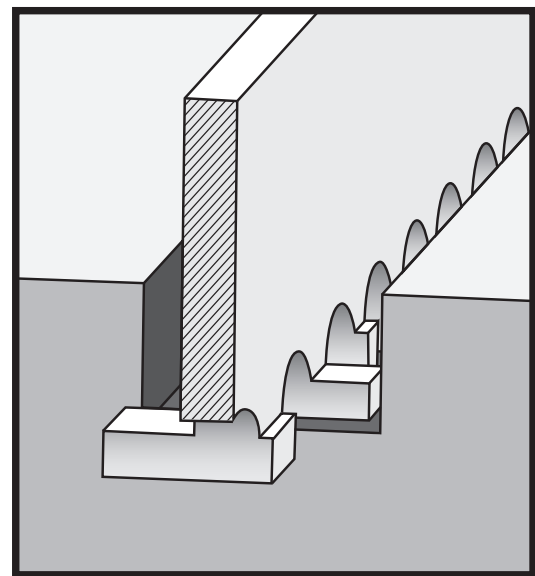

CUTTING TECHNOLOGIES



SPARC®

Engineered in to the blade, SPARC® technology employs a vibration assisted cutting action. This technology creates a rocking motion so tips move from cutting the material to rising out of the cut and then back in to the material. This extends the size range a blade can cut when compared to the same blade without the technology. It also allows for higher feed rates, cutting faster to deliver higher production. Extended blade life is another benefit of this technology.

Up to 25% Larger Material
can be cut with the same blade

Up to 20% Faster Cutting

Up to 20% Longer Life

Morse SPARC is available as an option for 2/3 and coarser TPI band saw blades in the following products

- ▼ M-Factor® GES
- ▼ M-Factor® GP
- ▼ Independence® EXS
- ▼ Independence® II
- ▼ Maverick®

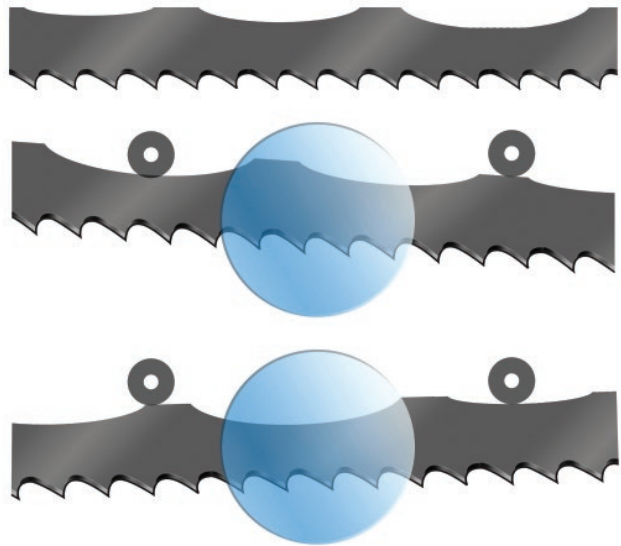

Exaggerated to illustrate blade feature and cutting action.

NO BACK EDGE

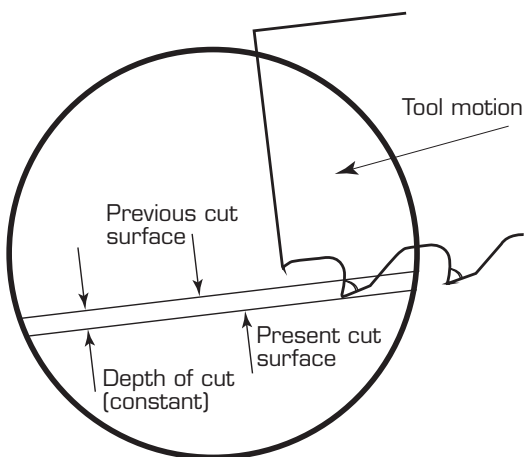

SPARC® CUTTING ACTION

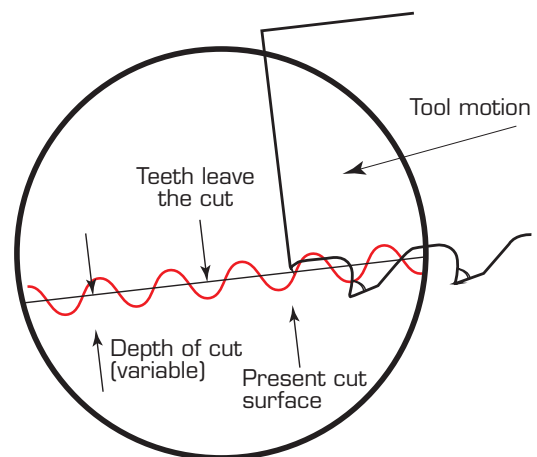



MORSE
PLYOMETRIC[®]
CUTTING ACTION

Engineered in to the blade, patent pending Morse Plyometric Cutting Action employs vibration assisted cutting technology that is optimized for the specific tooth design of each blade. With this technology the tips stay engaged in the material while cut angles change dynamically. This allows higher feed rates for faster cutting and higher production, particularly in hard-to-cut materials. And by optimizing how each tooth engages the material being cut, it reduces wear, extending blade life. Finally, this technology is optimized for full speed cutting, so blades should not be broken in.

Up to 50% Faster Cutting
Up to 50% Longer Blade Life

Morse Plyometric[®] cutting action is featured on:



NO BACK EDGE

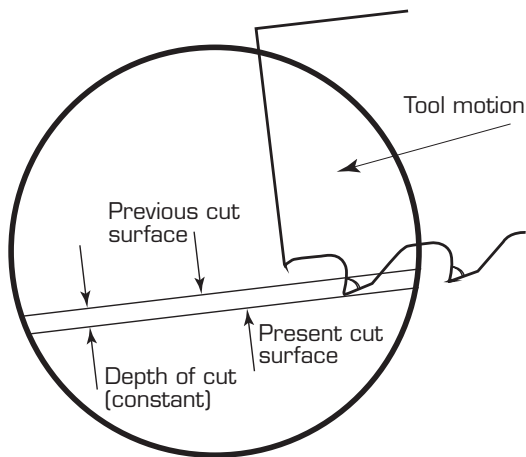

PLYOMETRIC[®] CUTTING ACTION

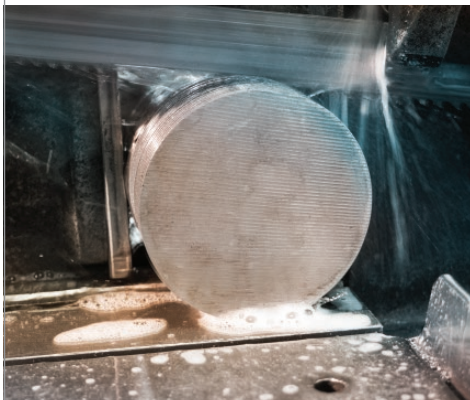
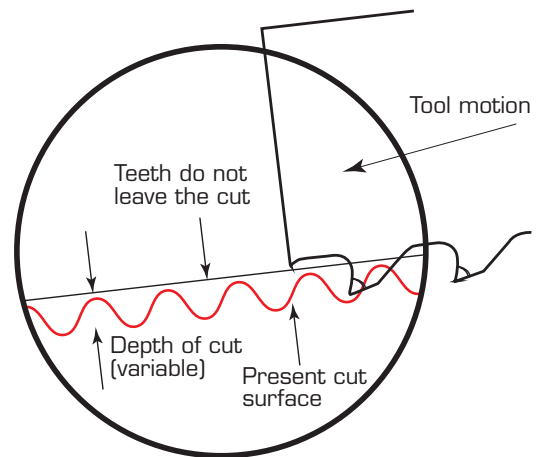



INDUSTRIAL BAND SAW BLADES

Blade Type	Application
Metal	
Carbide Tipped	Blades optimized for fastest cutting and longest life cutting super alloys, stainless steels and alloy steel.
Bi-Metal	Highly fatigue resistant to eliminate premature breakage. Excellent in solid tool steels and small to medium stainless and nickel based alloys.
Wood	
Carbide Tipped	Specially designed for fine-finish wood cutting in applications such as hardwood flooring, millwork and musical tonewoods.
Bi-Metal	Ideal for timber, wood production cutting and general purpose cutting of low alloy/non-ferrous metals.
Carbon	Designed for production cutting of wood, wood composites and general purpose cutting of low alloy steel and non-ferrous metals.
Specialty	
Carbide Grit	Ideal for cutting ceramics and other materials that are too hard or abrasive for standard bi-metal blades, tungsten carbide grit blades provide superior wear resistance.
Pallet	Specially designed to cut through pallet nails and staples when used on pallet machines.

Blade Selection		Carbide Tipped					Bi-Metal							Carbide Grit												
		M-Factor®					Premium		Structural		M42		Matrix II			Gulleted		Continuous								
		SPARC					SPARC																			
		JawBreaker®	GES	GP	CH	FB+	FBS	Independence® EXS	Independence® II	Maverick	The Morse Achiever®	Challenger®	Positive Rake	6° Rake	0° Rake	Raker	Hook	Positive Rake	0° Rake	Raker	Wavy	Hook	Medium	Medium Coarse	Coarse	Medium
Category	Type																									
Non-Ferrous Alloys	Aluminum																									
	Brass																									
	Bronze																									
	Copper																									
	Nickel Aluminum Bronze																									
Carbon Steel	General																									
	A36																									
Cast Iron																										
Case Hardened																										
Chrome Alloy Steels																										
Chrome Moly Steel																										
Chrome Vanadium Steel																										
Chromium Steel																										
Duplex Alloys																										
Free Machining Steel																										
Graphite																										
Magnesium																										
Manganese Steel																										
Maraging Steel																										
Molybdenum Steel																										
Nickel and Tool Steel																										
Nickel Steels, Alloys and Superalloys	2317																									
	2330, 2345																									
	2512, 2517																									
	Duranickel																									
	Inconel 617																									
	Monel R																									
	R-Monel																									
	NI-SPAN-C 962																									
	Nickel Alloy 617																									
	Nimonic 75																									
	Nimonic 90																									
	Rene 88																									
	Udimet 500																									
	Waspalloy																									
	Hastelloy A																									
	Hastelloy B																									
	Hastelloy C																									
	Incoloy 800 - 802																									
	Incoloy 804 - 825																									
	Inconel																									
	Inconel 625-x-750																									
	Inconel 718																									
	K-Monel																									
K-R-Monel																										
Monel																										
Rene 41																										
Nickel Chrome Moly Steel																										
Nickel Moly Steel																										
Stainless Steel	General																									
	Austenitic																									
	Ferritic																									
	Martensitic																									
Tantalum																										
Titanium Alloys																										
Tool steel	General																									
	Die Steels																									
	Mold Steels																									
	Hot Work, Low Alloy and High Speed Steels																									
	Water Hardening Steels																									
Plastics / Composites / Drywall / Laminates	Fiberglass																									
	Plexiglass																									
	Rubber																									
	PVC/ABS																									
	Composites																									
	Plastics																									
	Acoustic Ceiling Tile																									
	Drywall																									
	Plaster with Lath																									
	Plasterboard																									
	Computer flooring																									
	Countertops																									
Laminate Flooring																										
Stone / Cement / Brick / Ceramics	Architectural Stone																									
	Asbestos Board																									
	Cinder Block																									
	Brick (masonry)																									
	Cement																									
	Cement Board																									
	Ceramics																									
	Porcelain tile																									
	Granite																									
	Marble																									
	Stone																									
	Glass Block																									

- HIGHLY RECOMMENDED
- RECOMMENDED
- ACCEPTABLE

Note: SPARC is available as an option for identified products with 2/3 and coarser TPIs



METAL CARBIDE TIPPED



Do NOT
Break In



JAWBREAKER™



MORSE™

JAWBREAKER®

FEATURING EXCLUSIVE
PLYOMETRIC®
CUTTING ACTION

WITH
KERFLOCK®
TECHNOLOGY

For optimal performance
DO NOT BREAK IN Jawbreaker® blades

JAWBREAKER®

LARGE BILLET PRODUCTION CUTTING

Featuring patent pending Morse Plyometric cutting action together with patented Morse KerfLock technology, Jawbreaker sets a new benchmark for band saw blade performance. Designed for production cutting of large billets of superalloys and other very hard to cut materials, Jawbreaker delivers higher feed rates and longer blade life. And Jawbreaker blades should not be broken in, so there's no need to slow down after a blade change. If you need more capacity and higher production, Morse Jawbreaker is the answer.

Pat. No. 10, 279,408

Users: Forging, Steel Mills, Steel Service Centers, Machine Shops, Test Labs

Application: Alloy steels, Duplex alloys, Hardened Steel alloys, Nickel chrome moly steel, Stainless steels, Superalloys, Titanium alloys, Tool & die steels

Feature	Benefit	Value
Patent Pending Morse Plyometric Cutting Action	Up to 30% faster cuts Up to 2.5x longer blade life Reduces work hardening	Increases cutting capacity Lowers operating cost No blade break in Reduces blade inventory
Patented Morse KerfLock precision ground kerf	Consistent kerf through the life of the blade.	Prevents pinching Extends blade life Improved finish
Three optimized tooth designs	Cuts solids and thick wall shapes from 6" to 49" / 0.15 m – 1.25 m Cut materials from 28 to 65 HRC	Performs in the hardest to cut materials and sizes

Width x Thickness		TPI	
in	mm	.75/1	1.5/2
Variable			
2 x .063	54 x 1.60	▼	▼
2½ x .063	67 x 1.60	▼	▼
3 x .063	80 x 1.60	▼	▼



Operating Parameters:

- ▼ For optimal performance, Jawbreaker blades must be run at higher feed rates
- ▼ **DO NOT BREAK IN** Jawbreaker blades
- ▼ Please refer to the Morse Blade Wizard for recommended feeds and speeds for materials being cut



BladeWizard.com



M-FACTOR
 MORSE
 GES



For optimal performance
DO NOT BREAK IN M-Factor® GES blades

M-FACTOR® GES
GENERAL EXOTIC SPECIALTY

Featuring patented Kerflock Technology this blade is designed specifically for exotic material and ferrous steel, with particular emphasis on thick wall and solid billet applications, for exceptionally long life.

Pat. No. 10, 279,408

Users: Steel service centers, forging operations, specialized manufacturing

Application: All stainless steels, difficult to cut alloy steels, tool steels, titanium, nickel based alloys, Hastelloy, Inconel, Monel

Feature	Benefit	Value
Multi-chip tooth pattern	Reduces material build up on the tooth Reduces blade stress	Blade longevity
Precision Ground Carbide Teeth	Reduced vibration, heat and noise Energy focused on cutting	Greater efficiency in the workplace
High performance materials	Excellent fatigue life, wear life, and performance	Increased productivity
Patented Morse KerfLock precision ground kerf	Consistent kerf through the life of the blade.	Prevents pinching Extends blade life

in	Width x Thickness mm	TPI			
		.75/1	1.5/2	2/3	3/4
		Variable			
1¼ x .042	34 x 1.10			▼	▼
1½ x .050	41 x 1.30		▼ ▼	▼	▼
2 x .063	54 x 1.60	▼	▼ ▼	▼ ▼	▼
2 ⅞ x .063	67 x 1.60	▼ ▼	▼ ▼	▼	
3 x .063	80 x 1.60	▼ ▼	▼		

▼ Wide Kerf

M-FACTOR
 GP



For optimal performance
DO NOT BREAK IN M-Factor® GP blades

M-FACTOR® GP GENERAL PURPOSE

Specially designed for any small billet (<12", 30.5cm) ferrous steel applications for long life.

Users: Steel service centers, forging operations, general manufacturing

Application: Alloy steels, stainless steels (lower grades)

Feature	Benefit	Value
Longer blade life than bi-metal	Fewer blade changes Reduced downtime	Increased productivity Reduced cost per cut
Versatility	Reduced downtime and blade changes	Greater efficiency in the workplace

in	Width x Thickness mm	TPI			
		.75/1	1.5/2	2/3	3/4
		Variable			
1 x .035	27 x 0.90			▼	▼
1¼ x .042	34 x 1.10	▼	▼	▼	▼
1½ x .050	41 x 1.30		▼	▼	▼
2 x .063	54 x 1.60	▼	▼	▼	
2 ⅞ x .063	67 x 1.60	▼	▼	▼	
3 x .063	80 x 1.60	▼	▼		



METAL BI-METAL



MA
 Independence EXS
 ORSE
 TOOL COMPANY

Independence[®] EXS Made in USA

INDEPENDENCE[®] EXS HIGH PRODUCTION BI-METAL

This premium blade is the best choice for high production solid applications.

Users: Steel service centers, production cutting fabrication shops, general manufacturing

Applications: High production cutting, large solids, stainless steels, exotics

Feature	Benefit	Value
Unique tooth geometry	Superior wear, heat and shock resistance	Fewer blade changes Reduced downtime
Premium materials – tooth edge and backer	Blade longevity	Increased productivity

Width x Thickness		TPI				
in	mm	1/1.5	1.5/2	2/3	3/4	4/6
		Variable				
1 x .035	27 x 0.90			▼	▼	▼
1¼ x .042	34 x 1.10			▼	▼	▼
1½ x .050	41 x 1.30		▼	▼	▼	
2 x .063	54 x 1.60	▼	▼	▼	▼	



METAL BI-METAL

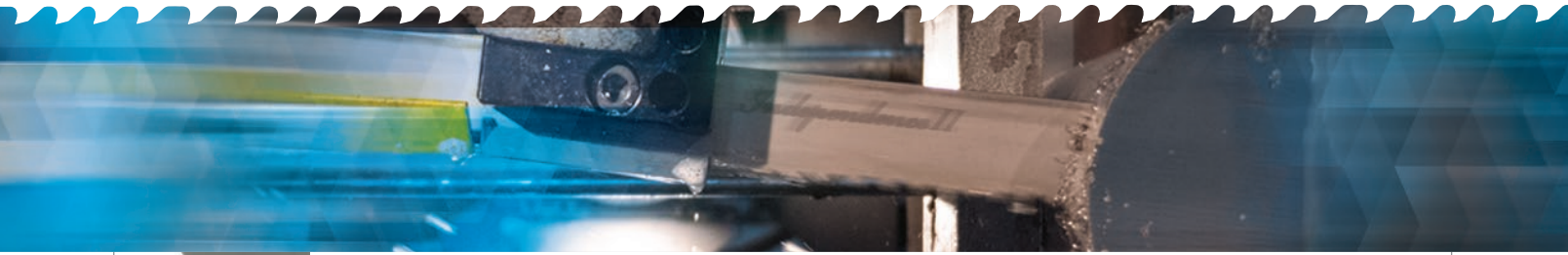

Independence II
 MORSE
 THE W. H. MORSE COMPANY



INDEPENDENCE® II HIGH PRODUCTION BI-METAL

While cutting almost anything, this blade is highly fatigue-resistant to eliminate premature breakage.

Users: Steel service centers, production and job shops, fabrication shops, general manufacturing

Applications: High production cutting, solids of tool steel (A2, D2, S7, etc.), small to medium solids of stainless (304, 316, 17-4), nickel based alloys (Inconel, Monel), all machineable metals in single pieces or bundles

Feature	Benefit	Value
Versatility	Cuts a variety of different materials to reduce blade changes	Increased production, efficiency
Premium materials – tooth edge and backer	Blade longevity	Increased productivity

Width x Thickness		TPI			
in	mm	2/3	3/4	4/6	5/7
Variable					
1 x .035	27 x 0.90	▼	▼	▼	▼
1¼ x .042	34 x 1.10	▼	▼	▼	▼
1½ x .050	41 x 1.30	▼	▼	▼	▼
2 x .063	54 x 1.60	▼	▼	▼	▼

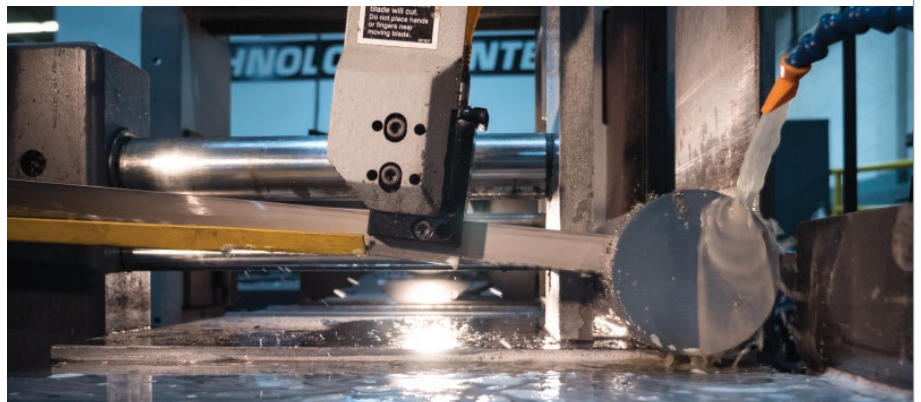



MAVERICK



MAVERICK®

MAVERICK® PRODUCTION

Featuring a patent pending blade design, Maverick performs in both production and job shop environments and is successful with the occasional structural workpiece.

* Maverick is designed to optimize blade longevity at targeted speeds. Running Maverick at increased speeds may reduce blade life benefits.

Users: Production facilities, job shops, fabrication and steel service centers

Application: Mild steels, stainless steels, tool steels, occasional structural workpiece

Feature	Benefit	Value
Longer blade life	Fewer blade changes Reduced downtime	Increased productivity Reduced cost per cut
Versatility	Reduced downtime and blade changes	Greater efficiency in the workplace
Blade harmonics	Energy concentrated on cutting	Reduced noise levels for operations Better blade performance

Width x Thickness		TPI							
in	mm	.75/1.1	1.1/1.5	1.4/2.5	1.5/2	2/3	3/4	4/6	5/7
		Variable							
1 x .035	27 x 0.90					▼	▼	▼	▼
1¼ x .042	34 x 1.10					▼	▼	▼	▼
1½ x .050	41 x 1.30			▼		▼	▼	▼	
2 x .063	54 x 1.60			▼		▼	▼		
2 ⅝ x .063	67 x 1.60	▼	▼		▼	▼	▼		
3 x .063	80 x 1.60	▼	▼						

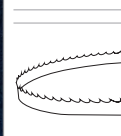

METAL BI-METAL



THE MORSE ACHIEVER

THE MORSE ACHIEVER®

THE MORSE ACHIEVER® PRODUCTION

Consistently reliable with excellent durability in mild to difficult materials – layer and bundle cuts and large profiles and solids.

Users: Production and tool shops, fabrication

Applications: Production cutting, material range from carbon to stainless steel (1018, 4140, 4340, tool and stainless steels).

Feature	Benefit	Value
0° rake offering	Cuts structural applications/thin wall pieces	Handles vibration and interruptions; greater productivity
Finer tooth pitches	Cuts smaller diameter and thin walled materials	Product selection to match specific needs

Width x Thickness		Variable Pitch - 0° Rake				
in	mm	4/6	5/8	6/10	8/12	10/14
1 x .035	27 x 0.90	▼	▼	▼	▼	▼
1¼ x .042	34 x 1.10	▼		▼		

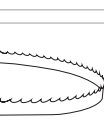
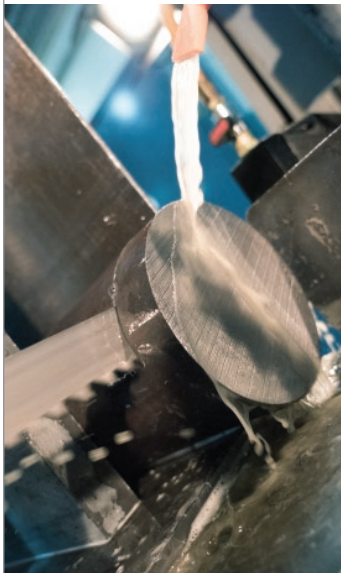

MORSE

CHALLENGER

Made



CHALLENGER® STRUCTURAL

Long life and straight cuts with reduced vibration and noise when cutting structural material.

Users: Production and tool shops, metal service centers, steel structure fabricators

Applications: Bundle cuts, interrupted cuts, I-beams, low alloy steels, carbon steels (A36)

Feature	Benefit	Value
Special tooth profile	Durability Less tooth stripping	Blade longevity Reduced blade changes
Increased beam strength	Straight interrupted and bundle cuts	No secondary operations
Less noise and vibration	Focused energy cutting	Increased productivity

Width x Thickness		TPI				
in	mm	2/3	3/4	4/6	5/7	8/11
		Variable				
½ x .025	13 x 0.64					▼
¾ x .035	19 x 0.90				▼	▼
1 x .035	27 x 0.90		▼	▼	▼	▼
1¼ x .042	34 x 1.10		▼ ▼	▼ ▼	▼	▼
1½ x .050	41 x 1.30	▼	▼ ▼	▼ ▼	▼	▼
2 x .063	54 x 1.60	▼ ▼	▼ ▼	▼ ▼		
2 ⅝ x .063	67 x 1.60	▼ ▼	▼ ▼	▼		

▼ Wide Kerf



METAL BI-METAL



M42 PRODUCTION & MRO

Durability for higher production speeds on difficult to machine materials.

Users: Production, tool, fabrication, maintenance shops, specialty shops, steel service centers

Application: Solids, heavy walled structures, carbon steels, alloy steels, some stainless steels, medium-to-heavy production machines

Feature	Benefit	Value
Durability	Blade longevity	Reduced blade changes / Reduced downtime
Versatility	Cuts a variety of materials	Reduced blade changes / Increased productivity
Variable, straight tooth pitches	Address a variety of applications	Increased productivity
Positive rake offering	Used primarily to cut solids	Designed for optimal performance
0° rake offering	Cuts structural and thin walled materials	Designed for optimal performance
Straight pitch, often finer tooth pitches	Cuts materials with consistent cross-sectional size ranges, thin materials, hand fed materials	Designed for optimal performance

M42

MORSE
THE M42 ADVANTAGE

Width x Thickness		TPI			
in	mm	2/3	3/4	4/6	5/7
Variable Pitch - Positive Rake					
¾ x .035	19 x 0.90			▼	
1 x .035	27 x 0.90	▼	▼▼	▼▼	▼
1¼ x .042	34 x 1.10	▼	▼▼	▼▼	▼
1½ x .050	41 x 1.30	▼	▼▼	▼▼	
2 x .050	54 x 1.30		▼		
2 x .063	54 x 1.60	▼	▼		

▼ Available with 6° rake angle

Width x Thickness		TPI					
in	mm	3/4	4/6	5/8	6/10	8/12	10/14
Variable Pitch - 0° Rake							
¾ x .025	6 x 0.64						▼
¾ x .035	6 x 0.90						▼
½ x .025	13 x 0.64					▼	
½ x .035	13 x 0.90						▼
¾ x .035	19 x 0.90		▼	▼	▼	▼	▼
1 x .035	27 x 0.90	▼	▼	▼	▼	▼	▼
1¼ x .042	34 x 1.10	▼	▼	▼		▼	
1½ x .050	41 x 1.30	▼	▼	▼			

Width x Thickness		TPI					
in	mm	10	14	1	1.14	2	4
		Raker		Hook			
¼ x .035	6 x 0.90	▼					
⅜ x .035	9 x 0.90						▼
½ x .035	13 x 0.90		▼				▼
1 x .035	27 x 0.90					▼	
1¼ x .042	34 x 1.10				▼		
2 x .050	54 x 1.30			▼			

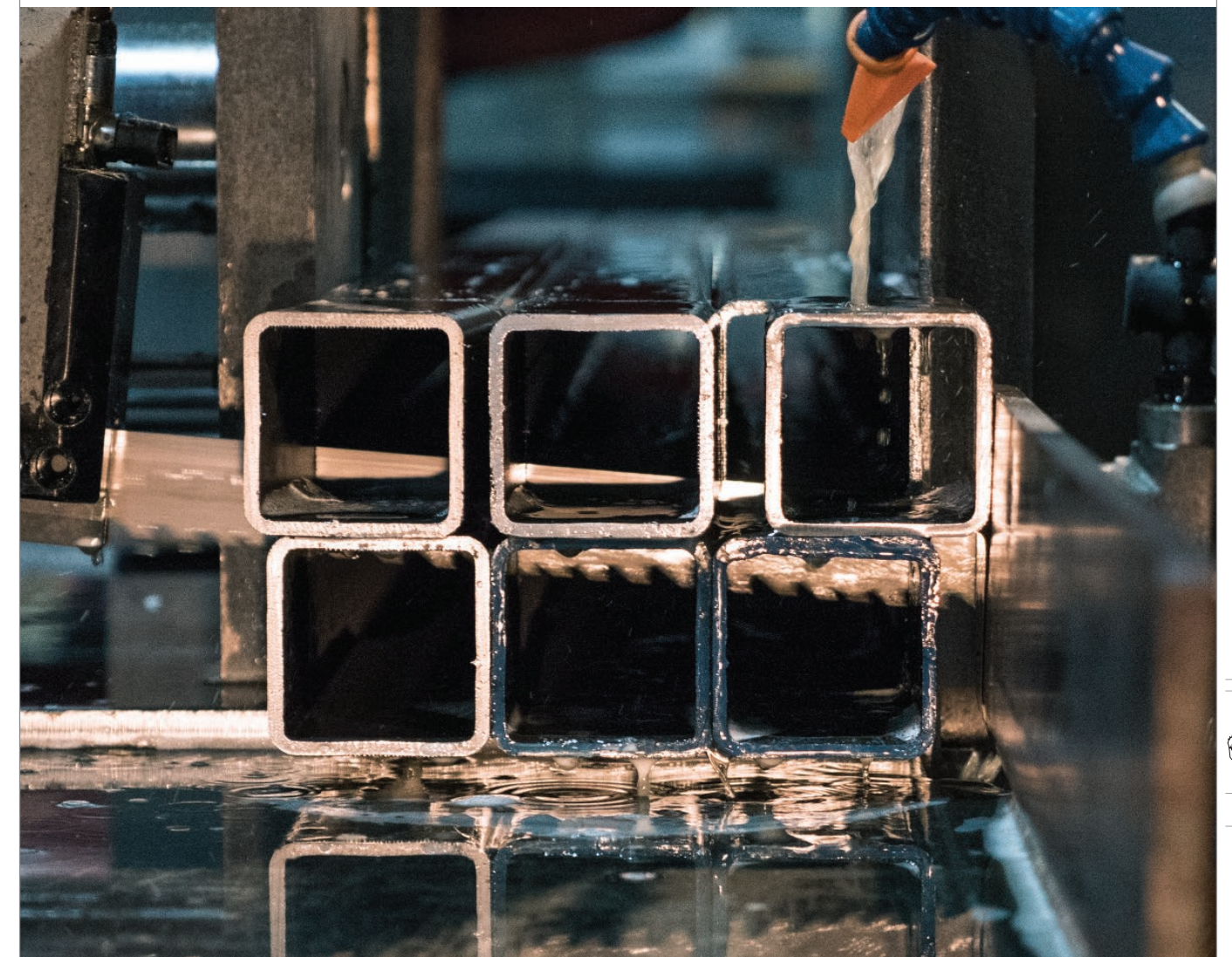

METAL BI-METAL



MATRIX II

MATRIX II PRODUCTION & MRO

Matrix II blades are ideal for cutting materials with easy to moderate machinability.

Users: Maintenance and fabricating shops

Applications: Carbon steels, structural steels – A36, single piece, bundles, stacked pieces, interrupted cuts (pipe and tubing, angle and channel, small and medium band saw machines)

Feature	Benefit	Value
Large portfolio selection	Positive rake, 0°, or straight pitch available	Meets all of your needs
Variable pitch, positive rake	Cuts solids and reduces vibration	Provides optimal performance
Variable pitch, 0°	Cuts structural applications/thin wall pieces	Designed for optimal performance in specific applications
Straight pitch, finer tooth pitches	Cuts materials with consistent cross sectional size ranges, thin and hand fed materials	Designed for optimal performance in specific applications

Width x Thickness		TPI	
in	mm	3/4	4/6
Variable Pitch - Positive Rake			
¾ x .035	19 x 0.90	▼	▼
1 x .035	27 x 0.90	▼	▼
1¼ x .042	34 x 1.10		▼

Width x Thickness		TPI							
in	mm	4/6	5/8	6/10	8/11	8/12	10/14	12/16	14/18
Variable Pitch - 0° Rake									
½ x .020	13 x 0.50				▼		▼	▼	▼
½ x .025	13 x 0.64			▼		▼	▼		▼
½ x .035	13 x 0.90						▼		
¾ x .035	19 x 0.90			▼		▼	▼		
1 x .035	27 x 0.90	▼	▼	▼		▼	▼		
1¼ x .042	34 x 1.10		▼	▼					

Width x Thickness		Straight Pitch										
in	mm	TPI					TPI			TPI		
		6	8	10	14	18	14	18	24	1.14	3	4
Raker Wavy Hook												
½ x .020	13 x 0.50			▼		▼	▼	▼				
½ x .025	13 x 0.64	▼			▼	▼					▼	▼
¾ x .035	19 x 0.90		▼	▼	▼						▼	
1 x .035	27 x 0.90				▼							
1¼ x .042	34 x 1.10									▼		

SPECIALTY BI-METAL



M42 BI-METAL DIE BAND BLADES

Designed for cutting solids with very low machinability including the toughest machinable materials.

Users: Tool and Die shops, also vertical band saw machines

Applications: Die blocks, tool steels, "D" grade steels, "Super" alloys, Inconel, Waspalloy, Hastelloy, tough materials

Feature	Benefit	Value
High heat and wear resistance	Production cutting ability	Fewer blade changes
Wide selection of blades	Tooth pitches, blade sizes to meet user needs	Increased productivity
Suited for difficult-to-cut materials	Versatility	Increased productivity

Width x Thickness		TPI				
in	mm	8/12	10/14	14	4	
		Variable		Raker		Hook
¼ x .025	6 x 0.64		▼			
¼ x .035	6 x 0.90		▼	▼		
⅜ x .035	9 x 0.90					▼
½ x .025	13 x 0.64	▼				
½ x .035	13 x 0.90		▼		▼	▼

MATRIX II

MATRIX II BI-METAL DIE BAND BLADES

Designed for cutting solids with very low machinability including the toughest machinable materials.

Users: Tool and Die shops, and vertical band saw machines

Applications: Die blocks, tool steels, "D" grade steels, tough materials

Feature	Benefit	Value
Economic option for low machinable materials	Blade durability	Low cost-per-cut Reduced blade changes Reduced downtime
Straight and variable tooth pitch options	Address a variety of applications	Increased productivity
High shock resistance	Better suited for thinner sections	Reduced blade changes Increased productivity

Width x Thickness		TPI					
in	mm	6/10	8/12	10/14	14	18	4
		Variable			Raker		Hook
½ x .025	13 x 0.64	▼	▼	▼	▼	▼	▼

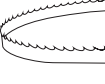

SPECIALTY GRIT

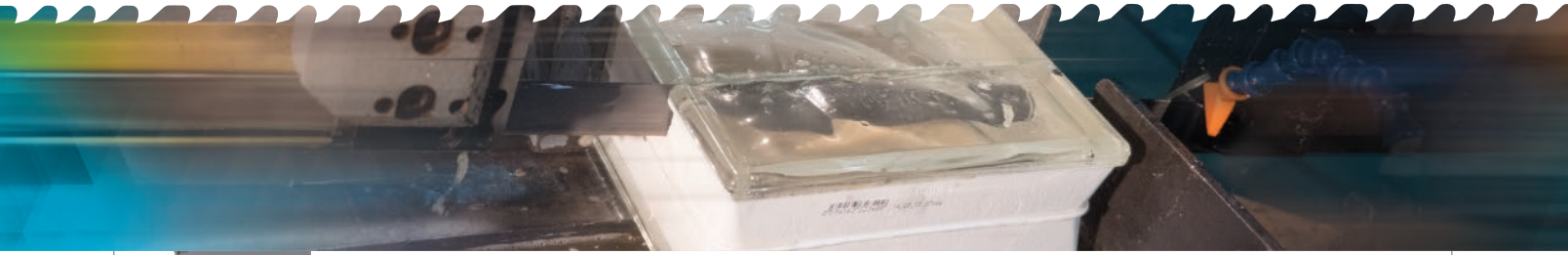

TUNGSTEN CARBIDE GRIT

TUNGSTEN CARBIDE GRIT

Ideal for cutting ceramics and other materials that are too hard or abrasive for standard bi-metal blades.

Users: Construction, glass and abrasive manufacturing, fabricators

Applications: Fiberglass, ceramics, cast iron, graphite, tires and wire reinforced rubber, cable and wire rope, brittle materials or surfaces that chip

Feature	Benefit	Value
Very smooth finish	No secondary operations	Greater productivity
Reversible, superior wear resistance	Extends blade service life	Increased blade life
Two different cutting edges	Continuous – for 1) brittle materials 2) thin materials that chip (<1/4" or 6.4mm) Gulleted – for 1) larger walled materials and (>1/4" (6.4mm)	Increased productivity for the specific applications
Different grit finishes	Medium – for 1) thin materials 2) fine finishes Coarse – for 1) thick materials	

Width x Thickness in mm		Gulleted			Continuous	
		Grit Type			Grit Type	
		Medium	Medium Coarse	Coarse	Medium	Coarse
¼ x .020	6 x 0.50				▼	
⅜ x .025	9 x 0.64	▼	▼			
½ x .025	13 x 0.64	▼	▼		▼	
¾ x .032	19 x 0.80		▼	▼		
1 x .035	27 x 0.90		▼	▼	▼	▼
1¼ x .042	34 x 1.10			▼		



WOOD CARBIDE TIPPED



CARBIDE TIPPED WOOD CUTTING

Specially designed for fine-finish wood cutting applications.

Users: Flooring production, mills, construction, fabricators, specialty shops

Applications: Hardwood flooring, millwork, musical tonewoods, MDF, other specialty wood cutting

For optimal performance
DO NOT BREAK IN QuikSilver® CT blades

Feature	Benefit	Value
Triple chip tooth design	Smooth finish	Eliminates secondary operations like sanding
Carbide tipped	Long blade life	Increased productivity
Cuts hard exotic woods	Versatility in cutting materials	Blade flexibility

Width x Thickness		TPI	
in	mm	.75/1	1.5/2.0
Carbide Tipped		Variable	
1½ x .050	41 x 1.30		▼
2 x .042	54 x 1.10	▼	



WOOD BI-METAL



QUIKSILVER® B1/B2

B1 – Commonly used for softwood to semi-hard wood (Pine, ash, poplar)

B2 – Commonly used for hard wood (Oak, walnut, cherry, maple)

BI-METAL WOOD CUTTING

Designed for wood based material production cutting.

Users: Vertical and horizontal resaw machines, portable saw mills, contour cutting on vertical machines

Applications: wood , Low alloy ferrous and non-ferrous metals

Feature	Benefit	Value
Bi-metal construction	Longer lasting blade	Greater productivity
High heat and wear resistance	Increased blade life	Fewer blade changes, down time
B1 – blade for soft wood to semi-hard wood	Cuts Pine, Ash, Poplar	Designed for optimal performance in specific application
B2 – blade for hardwood	Cuts Oak, Walnut, Cherry, Maple	Designed for optimal performance in specific application

Width x Thickness		TPI	
in	mm	5/8	1
			1.14

Bi-Metal	Variable	Hook
QuikSilver B1 Production / Wood Mill		
1¼ x .042	34 x 1.10	▼
QuikSilver B2 Production / Wood Mill		
1¼ x .042	34 x 1.10	▼
2 x .050	54 x 1.30	▼

▼ 1.14 Hook = 7/8" (22mm) Tooth Spacing

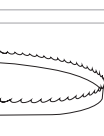

WOOD CARBON

QUIKSILVER® HEF/HB

HEF/HB WOOD MILL

Blades are manufactured from a single piece of high carbon steel with individually hardened tooth tips.

Users: Portable and stationary wood mills, single and multi-head resaw systems, Scragg mills

Applications: Wood cutting

Feature	Benefit	Value
Flex back and hard back options	Customize blade to your needs	Meets all of your needs
Flex back blades are more fatigue resistant	Longer blade life	Increased productivity
Hard back blades are more rigid	Offers straighter cuts	Provides optimal performance
Can be resharpened	Longer tooth life	Increased blade life

Hard Edge Flex Back - (HEF)

Width x Thickness		TPI		
in	mm	1.14	1.3	2
1 x .035	27 x 0.90			
1¼ x .035	32 x 0.90			
1¼ x .042	32 x 1.10	▼ ▼	▼	
1½ x .045	38 x 1.14	▼		
2 x .035	51 x 0.90		▼	
2 x .042	51 x 1.10	▼		

Hard Edge Hard Back - (HB)

Width x Thickness		TPI
in	mm	1.3
1 x .035	27 x 0.90	▼
1¼ x .035	32 x 0.90	▼
1¼ x .042	32 x 1.10	▼

Hook

Width x Thickness	Hook	Hook	Hook
in x mm	1.14	1.3	2
1 x .035 / 27 x 0.90		▼	▼
1¼ x .035 / 32 x 0.90		▼	
1¼ x .042 / 32 x 1.10	▼ ▼	▼	
1½ x .045 / 38 x 1.14	▼		
2 x .035 / 51 x 0.90		▼	
2 x .042 / 51 x 1.10	▼		

Hook

Width x Thickness	Hook
in x mm	1.3
1 x .035 / 27 x 0.90	▼
1¼ x .035 / 32 x 0.90	▼
1¼ x .042 / 32 x 1.10	▼

▼ Bright Finish

QUIKSILVER® WMF/WMH

QUIKSILVER® WOOD MILL

One-piece design to minimize blade fatigue.

Users: Wood cutting with increased fatigue resistance

Applications: Wood cutting

Wood Mill Flex Back - (WMF)

Width x Thickness		TPI		
in	mm	1.14	1.3	2
1 x .035	27 x 0.90		▼	▼
1¼ x .042	32 x 1.10	▼	▼	

Hook

Width x Thickness	Hook	Hook	Hook
in x mm	1.14	1.3	2
1 x .035 / 27 x 0.90		▼	▼
1¼ x .042 / 32 x 1.10	▼	▼	

Wood Mill Hard Back - (WMH)

Width x Thickness		TPI		
in	mm	1.14	1.3	2
1 x .035	27 x 0.90		▼	▼
1¼ x .042	32 x 1.10	▼	▼	
1½ x .045	38 x 1.14	▼		
2 x .042	51 x 1.10	▼		

Hook

Width x Thickness	Hook	Hook	Hook
in x mm	1.14	1.3	2
1 x .035 / 27 x 0.90		▼	▼
1¼ x .042 / 32 x 1.10	▼	▼	
1½ x .045 / 38 x 1.14	▼		
2 x .042 / 51 x 1.10	▼		

WOOD CARBON

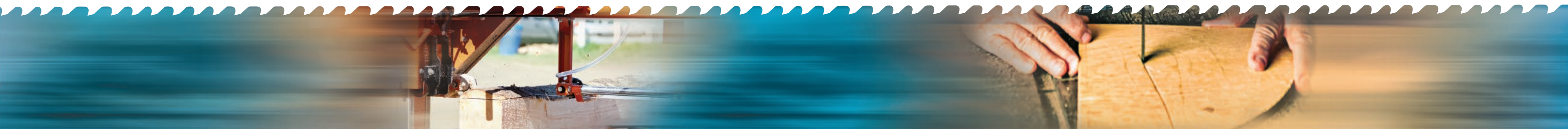

QUIKSILVER® FURNITURE BLADES

Blades offer faster cutting while maintaining precision required in the furniture industry.

Users: furniture industry, high-speed vertical cutting band saw machines

Applications: Used on large, vertical, high-speed wood cutting machines, wood, chip board, plywood, cardboard

Feature	Benefit	Value
Special ETS (every tooth set) pattern or Hook / Raker pattern. Both with 10° hook tooth design	Longer tooth tip life	Faster cutting
Flexible backer	Fatigue resistance	Increased blade life
Single construction with hardened tooth tips	Longer blade life	Increased productivity

Width x Thickness		TPI					
in	mm	3	4	2	3	4	6
		Hook ETS		Hook Raker Set			
¼ x .025	6 x 0.64					▼	▼
⅜ x .025	9 x 0.64	▼			▼	▼	▼
⅜ x .032	9 x 0.80	▼	▼				
½ x .025	13 x 0.64	▼			▼	▼	▼
½ x .032	13 x 0.80	▼	▼				
¾ x .032	19 x 0.80	▼		▼	▼	▼	▼

Minimum radius cut for a given blade width

Blade Width		Minimum Radius		Material Thickness 1/25mm
in	mm	in	mm	
1	25	7 ¼	184	
¾	19	5 7/16	138	
⅝	16	3 ¾	95	
½	13	2 ½	63	
⅜	10	1 ¼	32	
¼	6	¾	16	
⅜	5	¾	10	
⅛	3	¼	6	



QUIKSILVER® HB HARD BACK BLADES

Stiffer blades offer straighter cuts in wood and metal cutting.

Users: Wood cutting, maintenance, short metal production

Applications: Blade speeds <4,000 sfm, wood, plastic, cork, composition board, plywood, low alloy, easy-to-machine ferrous metals, non-ferrous metals (brass/copper, bronze, aluminum, lead)

Feature	Benefit	Value
Single construction with hardened tooth tips	Longer blade life	Increased productivity
Hardened and tempered backer	Straighter cuts with heavier feed pressure than flex back	Greater productivity and efficiency

Width x Thickness		TPI											
in	mm	6	10	14	18	12	14	18	1.3	2	3	4	6
		Raker			Wavy			Hook					
¼ x .025	6 x 0.64		▼	▼								▼	▼
⅜ x .025	9 x 0.64			▼								▼	▼
½ x .025	13 x 0.64	▼	▼	▼	▼			▼				▼	▼
⅝ x .032	16 x 0.80											▼	
¾ x .032	19 x 0.80	▼	▼	▼		▼	▼					▼	▼
1 x .035	27 x 0.90	▼	▼	▼					▼	▼		▼	
1¼ x .035	32 x 0.90								▼				
1¼ x .042	32 x 1.10	▼							▼				

▼ Standard Set - Regular Offset ▼ Double Set Raker (DSR)

WOOD CARBON



QUIKSILVER® HEF FLEX BACK BLADES

Designed to be more fatigue resistant than carbon hard back blades.

Users: wood production, short metal production, maintenance, general purpose cutting

Applications: Blade speeds up to 15,000 sfm, wood, plastic, cork, composition board, plywood, aluminum, non-ferrous metals, low alloy steel

Feature	Benefit	Value
Single construction with hardened tooth tips	Longer blade life	Increased productivity
More fatigue resistant than carbon hard back blades	Longer blade life	Optimal performance

Width x Thickness		TPI																
in	mm	6	8	10	14	18	24	18	32	1.14	1.3	2	3	4	6	4	6	
		Raker				Wavy		Hook				Skip						
1/8 x .025	3 x 0.64				▼	▼												
1/4 x .025	6 x 0.64			▼	▼	▼								▼	▼	▼	▼	
3/8 x .025	9 x 0.64		▼	▼	▼	▼							▼	▼	▼	▼		
1/2 x .020	13 x 0.50			▼														
1/2 x .025	13 x 0.64	▼		▼	▼	▼	▼	▼	▼				▼▼	▼	▼	▼		
5/8 x .032	16 x 0.80													▼	▼			
3/4 x .032	19 x 0.80	▼		▼	▼	▼							▼	▼	▼	▼		
3/4 x .050	19 x 1.30												▼					
1 x .035	27 x 0.90				▼								▼	▼	▼	▼		
1 1/4 x .035	32 x 0.90												▼					
1 1/4 x .042	32 x 1.10									▼	▼							
1 1/4 x .042 *Bright	32 x 1.10									▼								
1 1/2 x .045	38 x 1.14									▼								
2 x .035	51 x 0.90											▼						
2 x .042	51 x 1.10									▼								

▼ Standard Set ▼ Wide Kerf

* "Bright" specifications have an unblued, silver surface finish.



SPECIALTY PALLET



QUIKSILVER® PALLET DISMANTLING

Specially designed to withstand the rough service required on dismantling machines while cutting through pallet nails and staples.

Users: Pallet dismantlers

Applications: All types of band saw pallet dismantling machines, wood with nails / staples

Feature	Benefit	Value
Bi-metal options	Customize blades to your needs	Designed for optimal performance
Special grade carbon steel	Increased, rugged durability	Increased productivity
Straight or Variable pitch options available	Addresses various cutting needs	Provides optimal performance

M42 BI-METAL

Width x Thickness		TPI
in	mm	5/8
		Variable
1¼ x .042	32 x 110	▼

MATRIX II BI-METAL

Width x Thickness		TPI
in	mm	5/8
		Variable
1¼ x .042	32 x 110	▼

CARBON Hard Back (HB) Special

Width x Thickness		TPI	
in	mm	5/7	5/8
		Variable	
1¼ x .042	32 x 110	▼	▼



BLADE PART NUMBERS

The M. K. Morse Company uses 10-digit band saw blade part numbers (with a "C" or "R" suffix for coils).

The first 6-digits of the part number identify the material and size specifications. The last 4-digits identify the length of the blade for both weld-to-length bands and coil stock.

The band saw blade part number reference chart below provides the same details we have in-house to configure the new part numbers. Customer Service at M. K. Morse will assist all band saw blade distributors with any cross referencing needed. If you have any questions, please contact your M. K. Morse Customer Service Representative.

1 st and 2 nd Digits		Material/Tooth Set Style		3 rd and 4 th Digits		Blade Width		5 th and 6 th Digits		Tooth Count	
Part #	Material Type	Set Style		Part #	Width x Thickness	Part #	TPI				
00	M42	Positive, 6° Rake		10	.25 x .014	00	Carbide Grit				
10	QS HEF Carbon	Hook Raker – Special Extra Heavy Set		11	.375 x .014	01	1				
11	QS HEF Carbon	Hook – Heavy Set		20	.25 x .020	02	2				
13	QS HEF Carbon	Hook - Double Set Raker		21	.50 x .020	03	3				
14	QS HEF Carbon	Wavy		30	.125 x .025	04	4				
15	QS HEF Carbon	Skip		31	.1875 x .025	06	6				
16	QS HEF Carbon	Raker Or Variable Pitch		32	.25 x .025	88	6 w/prot*				
17	QS HEF Carbon	QuikSilver WMF - Hook		33	.375 x .025	08	8				
18	QS HEF Carbon	Hook		34	.50 x .025	10	10				
19	QS HEF Carbon	Hook ETS		40	.25 x .032	12	12				
20	QS HEF Carbon	Bright		41	.375 x .032	13	10 / 14				
26	QS HEF Carbon	Hook – Light Set		42	.50 x .032	14	14				
30	Matrix II	Positive Rake		43	.625 x .032	15	12 / 16				
31	Matrix II	Positive Rake – Heavy Set		44	.75 x .032	16	14 / 18				
33	Matrix II	0° Rake - Heavy Set		50	.25 x .035	18	18				
34	Matrix II	Wavy		51	.375 x .035	22	20 / 24				
36	Matrix II	Raker		52	.50 x .035	23	2 / 3				
38	Matrix II	Hook		53	.625 x .035	24	24				
39	Matrix II	0° Rake		54	.75 x .035	32	32				
40	M42	Positive Rake		55	1 x .035	34	3 / 4				
41	The Morse Achiever	10° Positive Rake		56	1.25 x .035	46	4 / 6				
42	M42	0° Rake		57	2 x .035	57	5 / 7				
43	The Morse Achiever	0° Rake		60	1 x .042	58	5 / 8				
46	M42	Raker		61	1.25 x .042	89	5/8 w/prot*				
47	The Morse Achiever	Variable – 6° Positive Rake		62	2 x .042	68	6 / 10				
48	M42	Hook		63	1.5 x .042	80	8 / 11				
49	The Morse Achiever	Heavy Set		70	1.25 x .045	81	8 / 12				
55	Independence II	Variable Pitch		71	1.5 x .045	91	.75 / 1.1				
57	Independence EXS	Variable Pitch		80	.75 x .050	92	1.4 / 2.5				
59	QS Hard Back Carbon	Hook ETS		81	1.5 x .050	93	1.3				
61	QS Hard Back Carbon	Hook – Heavy Set		82	2 x .050	94	1.14				
63	QS Hard Back Carbon	Hook - Double Set Raker		83	2 x .050**	96	1.1 / 1.5				
64	QS Hard Back Carbon	Wavy		84	1.5 x .055	97	1 / 1.5				
65	QS Hard Back Carbon	Skip		90	2 x .063	98	1.5 / 2				
66	QS Hard Back Carbon	Raker Or Variable Pitch		91	2.625 x .063						
67	QS Hard Back Carbon	QuikSilver WMH - Hook		92	3 x .063						
68	QS Hard Back Carbon	Hook									
70	Tun. Carbide Grit - Continuous	Medium									
71	Tun. Carbide Grit - Continuous	Medium Coarse									
72	Tun. Carbide Grit - Continuous	Coarse									
73	Tun. Carbide Grit - Gulleted	Medium									
74	Tun. Carbide Grit - Gulleted	Medium Coarse									
75	Tun. Carbide Grit - Gulleted	Coarse									
78	Maverick	Positive Rake									
80	M-Factor - Carbide Tipped	Aluminum Foundry (FB+)									
81	M-Factor - Carbide Tipped	Case Hardened (CH)									
82	M-Factor - Carbide Tipped	General Purpose (GP)									
84	M-Factor - Carbide Tipped	GES									
85	M-Factor - Carbide Tipped	Foundry Set (FBS)									
86	M-Factor - Carbide Tipped	GES Wide Set									
87	Jawbreaker - Carbide Tipped	Large Difficult-to-cut Materials									
91	Challenger	Positive Rake									
92	Challenger	Heavy Set									
GA	M-Factor - Carbide Tipped	Wood Production									

7 th , 8 th and 9 th Digits		Blade Length	
Number of feet multiplied by 12 plus additional inches. (Unless using Coil Stock. Coil Length (in feet) + C) If a RANDOM LENGTH coil - use 000R.			
10 th Digit		Fraction of Inch/ Millimeter	
Part #	Inch Length	Part #	mm Length
0	Even Length	0	Even Length
1	1/8"	1	3
2	1/4"	2	6.4
3	3/8"	3	9.5
4	1/2"	4	12.7
5	5/8"	5	16
6	3/4"	6	19
7	7/8"	7	22
C	Coil Stock	C	Coil Stock

7 th , 8 th and 9 th Digits		Metric Band Length	
Number of millimeters multiplied by .03937 equals total number of inches. (Unless using Coil Stock. Coil Length (in feet) + C) If a RANDOM LENGTH coil - use 000R.			

Example 1		Previous Part # ZCTNGES23	
Therefore:	M-Factor GES	1.5 x .050	2/3 100' Coil
Is shown as:	84	81	23 100C
New Part #	848123100C		

EXAMPLE 2		Previous Part # ZWEFH02M42HS	
Therefore:	M42 Straight Pitch Heavy Set	3/4 x .035	2 35' 8-1/2"
Is shown as:	45	54	02 428
New Part #	4554024284		(35 x 12 = 420) (420 + 8 = 428)

TOOTH SELECTION GUIDE

MATERIAL SIZE (INCHES)	TEETH PER INCH										MATERIAL SIZE (mm)
30"											762
25											635
20											508
15											381
13											330
11											279
9											229
7											178
5											127
4.5											114
4											102
3.5											89
3											76
2.75											70
2.5											64
2.25											57
2											51
1.75											44
1.5											38
1.25											32
1											25
0.75											19
0.50											13
0.25											6
	14/18	10/14	8/12	6/10	5/8	4/6	3/4	2/3	1.4/2.5	1/1.5	.75/1.0

WALL THICKNESS (INCHES)	TEETH PER INCH	WALL THICKNESS (mm)
1/16"		- 1.8
1/8"	10/14	- 3.2
3/16"	8/12	- 4.8
1/4"	6/10	- 6.3
5/16"	5/8	- 7.9
3/8"		- 9.5
7/16"		- 11.0
1/2"	4/6	- 12.7
9/16"		- 14.3
5/8"		- 15.8
11/16"		- 17.5
3/4"		- 19.0
13/16"		- 20.6
7/8"		- 22.0
15/16"	3/4	- 23.8
1"		- 25.4
1-1/8"		- 28.6
1-1/4"		- 32.0
1-3/8"	2/3	- 35.0
1-1/2"		- 38.0



Cutting Speeds (Structurals) Rule of Thumb

When cutting structurals use cutting speeds:

WET 250–325 S.F.M. | **DRY** 200–250 S.F.M.

Tooth Selection

Cut costs with the right choice.

For maximum cutting efficiency and lowest cost per cut, it is important to select the blade with the right number of teeth per inch (TPI) for the material being cut. The material size and shape dictate tooth selection.

Consider this:

(1) The width of the cut:

That is, the distance in the cut that each tooth must travel from the point it enters the work piece until it leaves the work piece.

(2) The shape of the work piece

Chart Usage

Select a pitch based on the chart above. Find material dimension on chart and move right/left for appropriate teeth per inch (TPI).

For angle, tubing, pipe, and other structural shapes, find the wall thickness in size column and move right/left for tooth size.

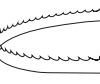

GUARANTEED TRIAL PROGRAM

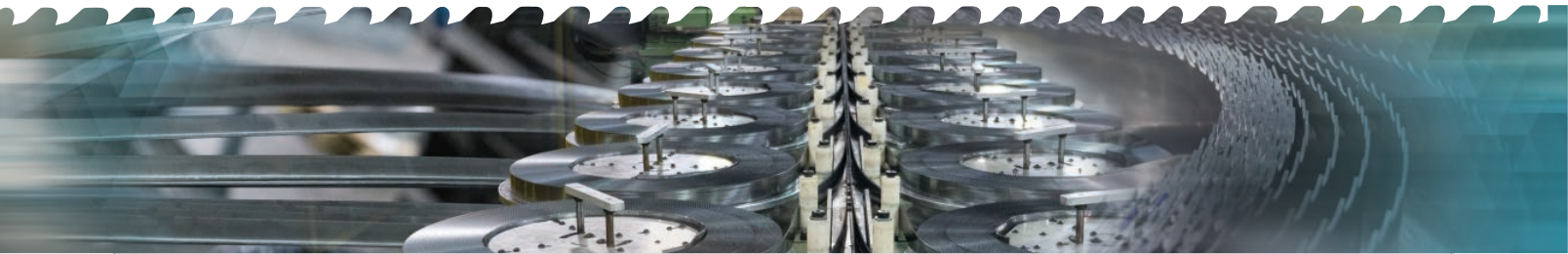

GUARANTEED TRIAL INDUSTRIAL SAW BLADES

The M. K. Morse Company will provide weld-to-length industrial band saw blades or industrial circular saw blades as a “Guaranteed Trial Order” (GTO) for the purpose of user evaluation of performance. If the blade recommended by Morse or approved by Morse for the particular application fails to perform satisfactorily for the user, Morse will issue full credit for the invoice value of the blade upon the return of the blade to Morse. In all instances where Morse provides weld-to-length industrial band saw blades or industrial circular saw blades for trial and evaluation, a Morse sales representative will provide follow-up. Morse is confident in the ability of our blades to meet end users expectations for performance.

BAND SAW MACHINE ACCESSORIES

BAND SAW TENSION GAUGE

Allows you to quickly check for under-tensioned or over-tensioned blade conditions while the blade is on the machine.

Users: Band saw operators, technicians

Applications: Used to measure band saw tension on the band saw



Model: TENSIONGAUGE **Part:** 005005

Feature	Benefit	Value
Offers proper blade tensioning	Calibrated gauge measuring in lb/in ² and kg/cm ²	Precise cutting results Optimal blade life Reduced machine damage from tensioning
Cast/powder coating and robust storage box	Durability of the unit and storage box	Maintains longevity of precision instrument

TOOTHBRUSH

The Morse Tooth Brush is a patent-pending magnetic chip brush that helps ensure optimal cutting conditions when using an industrial band saw blade.

Model: TOOTHBRUSHA **Part:** 183116 (Assembly with brush)

Model: TOOTHBRUSH-3 **Part:** 183123 (Brush refills - 3 pack)

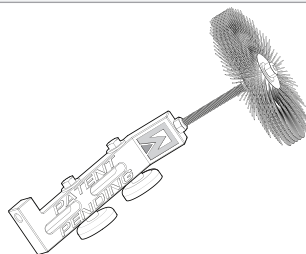
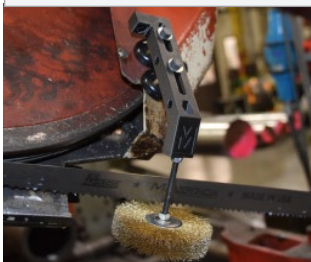

Feature	Benefit
Versatile	11 different machine configurations to fit a wide variety of machines
Strong	Made with Neodymium Magnets with a pull force rating of 75lbs.
Simple	Easy to install and change configuration with all standard M6 hardware.
Durable	Made with a long-lasting brass brush.

TOOTH PROTECTION

4000' .40 Band Tooth Protection (1 – 1-1/2")

Model: BNDEGPROTB **Part:** 004008

2000' .45 Band Tooth Protection (2" and larger)

Model: BNDEGPROT2B **Part:** 004015



CUT TIME CALCULATOR

Removal Rate - Square Inches Per Minute

Bar Dia.	Bar Area, In ²	1 IN ² /MIN	2 IN ² /MIN	3 IN ² /MIN	4 IN ² /MIN	5 IN ² /MIN	6 IN ² /MIN	7 IN ² /MIN	8 IN ² /MIN	9 IN ² /MIN	10 IN ² /MIN	11 IN ² /MIN	12 IN ² /MIN	13 IN ² /MIN	14 IN ² /MIN	15 IN ² /MIN	16 IN ² /MIN	17 IN ² /MIN	18 IN ² /MIN
		Minutes Per Cut																	
1.00	0.79	.79	.39	.26	.20	.16	.13	.11	.10	.09	.08	.07	.07	.06	.06	.05	.05	.05	.04
1.25	1.23	1.2	.61	.41	.31	.25	.20	.18	.15	.14	.12	.11	.10	.09	.09	.08	.08	.07	.07
1.50	1.77	1.8	.88	.59	.44	.35	.29	.25	.22	.20	.18	.16	.15	.14	.13	.12	.11	.10	.10
1.75	2.41	2.4	1.2	.80	.60	.48	.40	.34	.30	.27	.24	.22	.20	.19	.17	.16	.15	.14	.13
2.00	3.14	3.1	1.6	1.0	.79	.63	.52	.45	.39	.35	.31	.29	.26	.24	.22	.21	.20	.18	.17
2.25	3.98	4.0	2.0	1.3	1.0	.80	.66	.57	.50	.44	.40	.36	.33	.31	.28	.27	.25	.23	.22
2.50	4.91	4.9	2.5	1.6	1.2	1.0	.82	.70	.61	.55	.49	.45	.41	.38	.35	.33	.31	.29	.27
2.75	5.94	5.9	3.0	2.0	1.5	1.2	1.0	.85	.74	.66	.59	.54	.49	.46	.42	.40	.37	.35	.33
3.00	7.07	7.1	3.5	2.4	1.8	1.4	1.2	1.0	.88	.79	.71	.64	.59	.54	.50	.47	.44	.42	.39
3.25	8.30	8.3	4.1	2.8	2.1	1.7	1.4	1.2	1.0	.92	.83	.75	.69	.64	.59	.55	.52	.49	.46
3.50	9.62	9.6	4.8	3.2	2.4	1.9	1.6	1.4	1.2	1.1	1.0	.87	.80	.74	.69	.64	.60	.57	.53
3.75	11.04	11.0	5.5	3.7	2.8	2.2	1.8	1.6	1.4	1.2	1.1	1.0	.92	.85	.79	.74	.69	.65	.61
4.00	12.57	12.6	6.3	4.2	3.1	2.5	2.1	1.8	1.6	1.4	1.3	1.1	1.0	1.0	.90	.84	.79	.74	.70
4.25	14.19	14.2	7.1	4.7	3.5	2.8	2.4	2.0	1.8	1.6	1.4	1.3	1.2	1.1	1.0	.95	.89	.83	.79
4.50	15.90	15.9	8.0	5.3	4.0	3.2	2.7	2.3	2.0	1.8	1.6	1.4	1.3	1.2	1.1	1.1	1.0	.94	.88
4.75	17.72	17.7	8.9	5.9	4.4	3.5	3.0	2.5	2.2	2.0	1.8	1.6	1.5	1.4	1.3	1.2	1.1	1.0	1.0
5.00	19.64	19.6	9.8	6.5	4.9	3.9	3.3	2.8	2.5	2.2	2.0	1.8	1.6	1.5	1.4	1.3	1.2	1.2	1.1
5.25	21.65	21.6	10.8	7.2	5.4	4.3	3.6	3.1	2.7	2.4	2.2	2.0	1.8	1.7	1.5	1.4	1.4	1.3	1.2
5.50	23.76	23.8	11.9	7.9	5.9	4.8	4.0	3.4	3.0	2.6	2.4	2.2	2.0	1.8	1.7	1.6	1.5	1.4	1.3
5.75	25.97	26.0	13.0	8.7	6.5	5.2	4.3	3.7	3.2	2.9	2.6	2.4	2.2	2.0	1.9	1.7	1.6	1.5	1.4
6.00	28.27	28.3	14.1	9.4	7.1	5.7	4.7	4.0	3.5	3.1	2.8	2.6	2.4	2.2	2.0	1.9	1.8	1.7	1.6
6.25	30.68	30.7	15.3	10.2	7.7	6.1	5.1	4.4	3.8	3.4	3.1	2.8	2.6	2.4	2.2	2.0	1.9	1.8	1.7
6.50	33.18	33.2	16.6	11.1	8.3	6.6	5.5	4.7	4.1	3.7	3.3	3.0	2.8	2.6	2.4	2.2	2.1	2.0	1.8
6.75	35.78	35.8	17.9	11.9	8.9	7.2	6.0	5.1	4.5	4.0	3.6	3.3	3.0	2.8	2.6	2.4	2.2	2.1	2.0
7.00	38.48	38.5	19.2	12.8	9.6	7.7	6.4	5.5	4.8	4.3	3.8	3.5	3.2	3.0	2.7	2.6	2.4	2.3	2.1
7.25	41.28	41.3	20.6	13.8	10.3	8.3	6.9	5.9	5.2	4.6	4.1	3.8	3.4	3.2	2.9	2.8	2.6	2.4	2.3
7.50	44.18	44.2	22.1	14.7	11.0	8.8	7.4	6.3	5.5	4.9	4.4	4.0	3.7	3.4	3.2	2.9	2.8	2.6	2.5
7.75	47.17	47.2	23.6	15.7	11.8	9.4	7.9	6.7	5.9	5.2	4.7	4.3	3.9	3.6	3.4	3.1	2.9	2.8	2.6
8.00	50.27	50.3	25.1	16.8	12.6	10.1	8.4	7.2	6.3	5.6	5.0	4.6	4.2	3.9	3.6	3.4	3.1	3.0	2.8
8.25	53.46	53.5	26.7	17.8	13.4	10.7	8.9	7.6	6.7	5.9	5.3	4.9	4.5	4.1	3.8	3.6	3.3	3.1	3.0
8.50	56.75	56.7	28.4	18.9	14.2	11.3	9.5	8.1	7.1	6.3	5.7	5.2	4.7	4.4	4.1	3.8	3.5	3.3	3.2
8.75	60.13	60.1	30.1	20.0	15.0	12.0	10.0	8.6	7.5	6.7	6.0	5.5	5.0	4.6	4.3	4.0	3.8	3.5	3.3
9.00	63.62	63.6	31.8	21.2	15.9	12.7	10.6	9.1	8.0	7.1	6.4	5.8	5.3	4.9	4.5	4.2	4.0	3.7	3.5
9.25	67.20	67.2	33.6	22.4	16.8	13.4	11.2	9.6	8.4	7.5	6.7	6.1	5.6	5.2	4.8	4.5	4.2	4.0	3.7
9.50	70.88	70.9	35.4	23.6	17.7	14.2	11.8	10.1	8.9	7.9	7.1	6.4	5.9	5.5	5.1	4.7	4.4	4.2	3.9
9.75	74.66	74.7	37.3	24.9	18.7	14.9	12.4	10.7	9.3	8.3	7.5	6.8	6.2	5.7	5.3	5.0	4.7	4.4	4.1
10.00	78.54	78.5	39.3	26.2	19.6	15.7	13.1	11.2	9.8	8.7	7.9	7.1	6.5	6.0	5.6	5.2	4.9	4.6	4.4

To find the area of bars larger than 10" diameter use the formula " $\pi(3.14) \times \text{radius}^2$ ". Take half the diameter (radius) multiply it by itself. Then multiply that by 3.14. Example: 20" bar. Half the diameter is 10". $10 \times 10 = 100$. $100 \times 3.14 = 314$ square inches.



BladeWizard.com

* Specific speed/feed rates and cut times for all applications and blades can be found on the Morse Blade Wizard



BLADE SPEED/REMOVAL RATES

For use with Bi-Metal Blades*







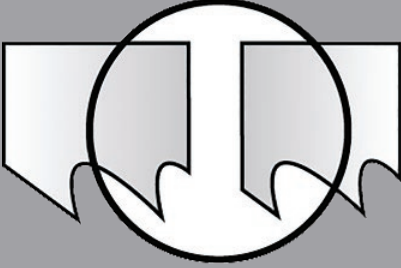
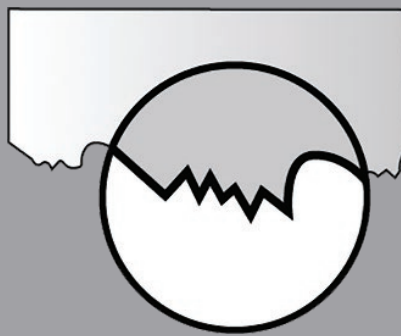

Stock Dimensions Tooth Pitch	Up to 2" 5/7, 5/8, 4/6, 3/4		From 2" - 4" 4/6, 3/4		From 4" - 6" 3/4, 2/3		From 6" - 10" 1.4/2.5, 1.5/2		From 10" - 12" 1.4/2.5, 1.5/2		From 12" - 16" 1.0/1.5, 1.1/1.5, .75/1.0		From 16" - 20" 1.0/1.5, 1.1/1.5, .75/1.0	
	Blade Speed (SFPM)	Cutting Rate (SIPM)	Blade Speed (SFPM)	Cutting Rate (SIPM)	Blade Speed (SFPM)	Cutting Rate (SIPM)	Blade Speed (SFPM)	Cutting Rate (SIPM)	Blade Speed (SFPM)	Cutting Rate (SIPM)	Blade Speed (SFPM)	Cutting Rate (SIPM)	Blade Speed (SFPM)	Cutting Rate (SIPM)
Aluminum Alloys:														
2024 - 5052 6061 - 7075	300	10 - 15	300	10 - 15	300	10 - 15	300	10 - 15	300	10 - 15	300	10 - 15	300	10 - 15
Copper Alloys														
CDA 220	250	8 - 12	230	7 - 11	220	7 - 11	210	6 - 10	200	5 - 9	180	4 - 8	150	4 - 8
CDA 360	325	11 - 15	300	10 - 15	290	10 - 15	275	8 - 12	250	7 - 11	225	6 - 10	200	5 - 10
Copper Nickel (30%)	230	7 - 11	220	7 - 11	200	6 - 10	180	5 - 9	160	5 - 9	140	4 - 8	120	4 - 8
Beryllium Copper	180	5 - 9	170	5 - 9	160	4 - 8	140	4 - 8	130	3 - 7	120	3 - 7	110	3 - 7
Bronze Alloys														
AMPCO 18	200	5 - 9	180	5 - 9	170	4 - 8	150	4 - 8	140	4 - 8	130	4 - 8	120	3 - 7
AMPCO 21	170	4 - 8	160	4 - 8	150	4 - 8	140	4 - 8	130	3 - 7	120	3 - 7	110	2 - 6
AMPCO 25	120	2 - 6	110	2 - 6	100	2 - 6	100	1 - 5	90	1 - 5	80	1 - 5	70	1 - 5
Leaded Tin Bronze	320	10 - 15	300	10 - 15	280	10 - 15	260	7 - 11	220	5 - 9	200	4 - 8	180	4 - 8
Aluminum Bronze 865	160	6 - 10	150	6 - 10	140	5 - 9	130	4 - 8	120	3 - 7	110	2 - 6	100	2 - 6
Manganese Bronze 932	230	7 - 11	220	7 - 11	210	6 - 10	190	6 - 10	170	5 - 9	150	4 - 8	140	3 - 7
937	300	10 - 14	290	10 - 14	270	9 - 13	250	6 - 10	220	5 - 9	200	5 - 9	160	4 - 8
937	270	8 - 12	250	8 - 12	240	7 - 11	210	6 - 10	200	5 - 9	180	5 - 9	160	4 - 8
Brass Alloys														
Cartridge / Red Brass (85%)	240	9 - 13	220	8 - 12	210	8 - 12	200	7 - 11	180	6 - 10	160	4 - 10	140	4 - 10
Naval Brass	220	6 - 10	200	6 - 10	190	6 - 10	170	4 - 8	160	4 - 8	140	4 - 8	130	4 - 8
Carbon Steels														
1008, 1013, 1015, 1018, 1035, 1045, 1048	300	11 - 15	280	10 - 14	260	10 - 14	240	8 - 12	220	6 - 10	200	6 - 10	180	4 - 8
1030	270	8 - 12	250	8 - 12	240	7 - 11	210	6 - 10	200	5 - 9	180	5 - 9	160	4 - 8
1060, 1065	230	7 - 11	220	7 - 11	210	6 - 10	190	6 - 10	170	5 - 9	150	4 - 8	140	3 - 7
1080, 1095	220	7 - 11	210	6 - 10	200	6 - 10	180	5 - 9	160	5 - 9	140	4 - 10	130	4 - 10
Free Machining Steels														
1108, 1111, 1112, 1113, 1115, 1137, 1145, 1151, 1212, 1213	300	11 - 15	280	10 - 14	260	10 - 14	240	8 - 12	220	6 - 10	200	6 - 10	180	4 - 8
1215	350	12 - 16	330	12 - 16	310	12 - 16	290	10 - 14	280	8 - 12	260	8 - 12	240	6 - 10
12L14	380	12 - 16	360	12 - 14	340	12 - 14	320	10 - 14	300	8 - 12	260	8 - 12	230	6 - 10
Structural Steel														
A36	280	10 - 14	260	10 - 14	240	10 - 14	220	8 - 12	200	8 - 12	180	6 - 10	160	6 - 10
Manganese Steels														
1320, 1330, 1345	270	8 - 12	250	8 - 12	240	7 - 11	210	6 - 10	200	5 - 9	180	5 - 9	160	4 - 8
1513, 1524, 1536	250	5 - 9	240	5 - 9	230	5 - 8	210	4 - 8	200	4 - 8	180	3 - 7	160	3 - 7
1541, 1312	220	7 - 11	210	6 - 10	200	6 - 10	180	5 - 9	160	5 - 9	140	4 - 10	130	4 - 10
1524	200	6 - 10	190	6 - 10	180	5 - 9	160	4 - 8	140	4 - 8	120	4 - 8	100	3 - 7
Molybdenum Steels														
4017, 4024, 4032, 4042	270	8 - 12	250	8 - 12	240	7 - 11	210	6 - 10	200	5 - 9	180	5 - 9	160	4 - 8
4047, 4066	220	7 - 11	210	6 - 10	200	6 - 10	180	5 - 9	160	5 - 9	140	4 - 10	130	4 - 10
Chrome Moly Steels														
4130, 4140, 4150, 4150H	250	5 - 9	240	5 - 9	230	5 - 8	210	4 - 8	200	4 - 8	180	3 - 7	160	3 - 7
4142, 4150	200	6 - 10	190	6 - 10	180	5 - 9	160	4 - 8	140	4 - 8	120	4 - 8	100	3 - 7
Chrome Alloy Steels														
5045, 5046, 5120, 5135	250	5 - 9	240	5 - 9	230	5 - 8	210	4 - 8	200	4 - 8	180	3 - 7	160	3 - 7
5140, 5160, 6117, 6120	220	7 - 11	210	6 - 10	200	6 - 10	180	5 - 9	160	5 - 9	140	4 - 10	130	4 - 10
50100, 52100	180	5 - 9	170	5 - 9	160	5 - 9	150	4 - 8	130	4 - 8	120	3 - 7	100	3 - 7
6150	200	6 - 10	190	6 - 10	180	5 - 9	160	4 - 8	140	4 - 8	120	4 - 8	100	3 - 7
Nickel Chrome-Moly Steels														
4317, 4320, 8615, 8620, 8627, 9747, 9763	230	7 - 11	220	7 - 11	210	6 - 10	190	6 - 10	170	5 - 9	150	4 - 8	140	3 - 7
4337, 4340	210	5 - 9	200	5 - 9	190	5 - 9	170	4 - 8	160	4 - 8	140	3 - 7	130	3 - 7
8630, 8640, 8645, 8647, 8660, 8715, 8750, 9437, 9445	200	6 - 10	190	6 - 10	180	5 - 9	160	4 - 8	140	4 - 8	120	4 - 8	100	3 - 7
9310, 9317	170	2 - 6	160	2 - 6	150	1 - 5	130	1 - 5	120	1 - 5	110	1 - 5	100	1 - 5
9840, 9850	220	7 - 11	210	6 - 10	200	6 - 10	180	5 - 9	160	5 - 9	140	4 - 10	130	4 - 10
E9310	180	5 - 9	170	5 - 9	160	5 - 9	150	4 - 8	130	4 - 8	120	3 - 7	100	3 - 7
Nickel-Moly Steels														
4608, 4621	220	7 - 11	210	6 - 10	200	6 - 10	180	5 - 9	160	5 - 9	140	4 - 10	130	4 - 10
4640	200	6 - 10	190	6 - 10	180	5 - 9	160	4 - 8	140	4 - 8	120	4 - 8	100	3 - 7
4812, 4820	180	5 - 9	170	5 - 9	160	5 - 9	150	4 - 8	130	4 - 8	120	3 - 7	100	3 - 7
Silicon Steels														
9255, 9260	180	5 - 9	170	5 - 9	160	5 - 9	150	4 - 8	130	4 - 8	120	3 - 7	100	3 - 7
9261, 9262	170	2 - 6	160	2 - 6	150	1 - 5	130	1 - 5	120	1 - 5	110	1 - 5	100	1 - 5
Low Alloy Tool Steels														
L-6, L-7	180	5 - 9	170	5 - 9	160	5 - 9	150	4 - 8	130	4 - 8	120	3 - 7	100	3 - 7
Water-Hardening Tool Steels														
W-1	200	6 - 10	190	6 - 10	180	5 - 9	160	4 - 8	140	4 - 8	120	4 - 8	100	3 - 7

* Reduce speeds by 50% for carbon blades. For carbide tipped blades, ask your Morse sales contact.

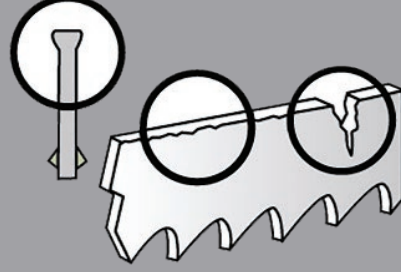
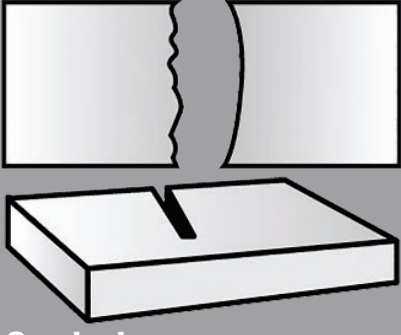
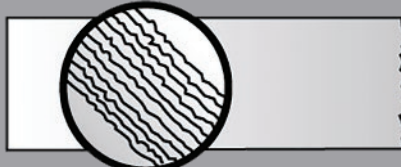
For use with Bi-Metal Blades*

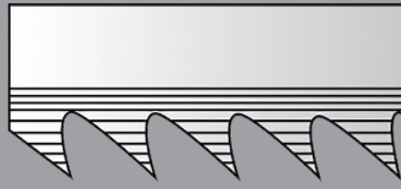
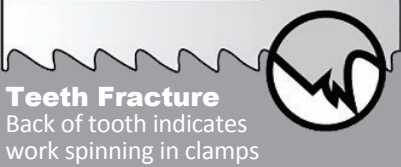
Stock Dimensions Tooth Pitch	Up to 2" 5/7, 5/8, 4/6, 3/4		From 2" - 4" 4/6, 3/4		From 4" - 6" 3/4, 2/3		From 6" - 10" 1.4/2.5, 1.5/2		From 10" - 12" 1.4/2.5, 1.5/2		From 12" - 16" 1.0/1.5, 1.1/1.5, .75/1.0		From 16" - 20" 1.0/1.5, 1.1/1.5, .75/1.0	
	Blade Speed (SFPM)	Cutting Rate (SIPM)	Blade Speed (SFPM)	Cutting Rate (SIPM)	Blade Speed (SFPM)	Cutting Rate (SIPM)	Blade Speed (SFPM)	Cutting Rate (SIPM)	Blade Speed (SFPM)	Cutting Rate (SIPM)	Blade Speed (SFPM)	Cutting Rate (SIPM)	Blade Speed (SFPM)	Cutting Rate (SIPM)
Die Steels														
D-2, D-3	100	1 - 5	90	1 - 5	80	1 - 5	70	1 - 5	60	1 - 5	50	1 - 5	40	1 - 5
D-7	80	1 - 5	70	1 - 5	60	1 - 5	50	1 - 5	40	1 - 5	30	1 - 5	20	1 - 5
A-2	180	4 - 8	170	4 - 8	160	4 - 8	150	4 - 8	130	3 - 7	110	3 - 7	100	2 - 6
A-6	140	2 - 6	130	2 - 6	120	2 - 6	110	1 - 5	100	1 - 5	90	1 - 5	80	1 - 5
A-10	110	2 - 6	100	2 - 6	90	2 - 6	80	2 - 6	70	2 - 6	60	2 - 6	50	2 - 6
O-1, O-2, O-6	250	5 - 9	240	5 - 9	230	5 - 8	210	4 - 8	200	4 - 8	180	3 - 7	160	3 - 7
Hot Work Tool Steels														
H-11, H12, H-13, H-13 Mod, H21	150	2 - 6	140	2 - 6	130	2 - 6	120	1 - 5	110	1 - 5	100	1 - 5	90	1 - 5
H-22, H-24 H-25	100	1 - 5	90	1 - 5	80	1 - 5	70	1 - 5	60	1 - 5	50	1 - 5	40	1 - 5
High Speed Tool Steels														
M-1	140	2 - 6	130	2 - 6	120	2 - 6	110	1 - 5	100	1 - 5	90	1 - 5	80	1 - 5
M-2, M-3, M-10	110	2 - 6	100	2 - 6	90	2 - 6	80	2 - 6	70	2 - 6	60	2 - 6	50	2 - 6
M-4, M-42, T-1	100	1 - 5	90	1 - 5	80	1 - 5	70	1 - 5	60	1 - 5	50	1 - 5	40	1 - 5
T-15	80	1 - 5	70	1 - 5	60	1 - 5	50	1 - 5	40	1 - 5	30	1 - 5	20	1 - 5
Mold Steels														
P-3	190	5 - 9	180	5 - 9	170	5 - 9	150	4 - 8	140	4 - 8	130	4 - 8	120	3 - 7
P-20	180	4 - 8	170	4 - 8	160	4 - 8	150	3 - 7	140	3 - 7	130	3 - 7	110	2 - 6
Shock Resistant Tool Steels:														
S-1, S-7	180	4 - 8	170	4 - 8	160	4 - 8	150	4 - 8	130	3 - 7	110	3 - 7	100	2 - 6
S-2, S-5	150	2 - 6	140	2 - 6	130	2 - 6	120	1 - 5	110	1 - 5	100	1 - 5	90	1 - 5
Stainless Steels:														
201, 202, 302, 304, 321, 347	110	2 - 6	100	2 - 6	90	2 - 6	80	2 - 6	70	2 - 6	60	2 - 6	50	2 - 6
303, 303F	120	2 - 6	110	2 - 6	100	2 - 6	90	1 - 5	80	1 - 5	70	1 - 5	60	1 - 5
308, 309, 310, 330, 430, 446	80	1 - 5	70	1 - 5	60	1 - 5								





BLADE PROBLEM SOLVING

Problem	Problem Cause	Solution	Problem	Problem Cause	Solution
 <p>Premature Blade Breakage Straight Break indicates fatigue</p>	<ul style="list-style-type: none"> Incorrect tooth pitch Blade tension incorrect Side guides too tight Damaged or misadjusted blade guides Excessive feed/force Incorrect cutting fluid Wrong blade size for _____ Blade rubbing on wheel flanges Teeth in contact with work before starting saw Incorrect blade speed 	<ul style="list-style-type: none"> Use correct tooth pitch Check blade tension with Band Tension Gauge Check side guide clearance (see machine manual) Check all guides for alignment/damage Reduce feed pressure/force Check coolant/refract Use correct size blade Adjust wheel alignment Allow clearance before starting cut Increase or decrease blade speed 	 <p>Teeth Stripping</p>	<ul style="list-style-type: none"> Feed pressure too high Tooth stuck in cut Improper or insufficient coolant Incorrect tooth size Hard spots in material Work spinning in vise - loose nest or bundle Blade speed too slow Blade teeth running backwards Chip brush not working 	<ul style="list-style-type: none"> Reduce feed pressure Do not enter old cut with a new blade Check coolant flow and concentration/refract Check tooth size chart (Page 33) Check material for hard inclusions Check clamping pressure - be sure work is held firmly Increase blade speed Reverse blade (turn inside out) Repair or replace chip brush
 <p>Premature Dulling of Teeth</p>	<ul style="list-style-type: none"> Teeth pointing in wrong direction / blade mounted backwards Improper or no blade break-in Hard spots in material Material work hardened Improper coolant Improper coolant concentration Speed too high Feed too light Improper tooth count 	<ul style="list-style-type: none"> Install blade correctly. If teeth are facing the wrong direction, flip blade inside out Break in blade properly (Page 10) Check for hardness or hard spots like scale or flame cut areas Increase feed rate Check coolant type Check coolant/refract Check recommended blade speed Increase feed rate Select proper tooth size 	 <p>Wear on Back of Blades</p>	<ul style="list-style-type: none"> Excessive feed pressure Insufficient blade tension Back-up guide frozen, damaged, or worn Blade rubbing on wheel flange 	<ul style="list-style-type: none"> Decrease feed pressure Increase blade tension and readjust guides Repair or replace back-up guide Adjust wheel alignment
 <p>Crooked or Out of Square Cuts</p>	<ul style="list-style-type: none"> Tooth set damage Excessive feed pressure/force Improper tooth size Cutting fluid not applied evenly Guides worn or loose Insufficient blade tension Guide arms loose or set too far apart Chips not being cleaned from gullets 	<ul style="list-style-type: none"> Check for worn set on one side of blade Reduce feed pressure/force Check tooth size chart (Page 33) Check coolant nozzles Tighten or replace guides, check for proper alignment Adjust to recommended tension Position arms as close to work as possible. Tighten arms. Check chip brush 	 <p>Rough Cut Washboard surface vibration and or chatter</p>	<ul style="list-style-type: none"> Dull or damaged blade Incorrect speed or feed Insufficient blade support Incorrect tooth pitch Insufficient coolant 	<ul style="list-style-type: none"> Replace with new blade Use correct speed and feed Move guide arms as close as possible to the work Use finer pitch blade Check coolant flow
 <p>Chip Welding</p>	<ul style="list-style-type: none"> Insufficient coolant flow Wrong coolant concentration Excessive speed and/or pressure Tooth size too small Chip brush not working 	<ul style="list-style-type: none"> Check coolant level and flow Check coolant ratio/refract Reduce speed and/or pressure Use coarser tooth pitch Repair or replace chip brush 	 <p>Wear Lines, Loss of Set</p>	<ul style="list-style-type: none"> Saw guide inserts or wheel flange are riding on teeth Insufficient blade tension Hard spots in material Back-up guide worn 	<ul style="list-style-type: none"> Check machine manual for correct blade width Tension blade properly Check material for inclusions Replace guide
 <p>Teeth Fracture Back of tooth indicates work spinning in clamps</p>	<ul style="list-style-type: none"> Incorrect speed and/or feed Incorrect tooth pitch Saw guides not adjusted properly Chip brush not working Work spinning or moving in vise 	<ul style="list-style-type: none"> Check cutting chart (Page 34-35) Check tooth size chart (Page 33) Adjust or replace saw guides Repair or replace chip brush Check bundle configuration/adjust vise pressure 	 <p>Twisted Blade Profile sawing</p>	<ul style="list-style-type: none"> Blade binding in cut Side guides too tight Wrong size blade Work not firmly held Erratic coolant flow Incorrect blade tension 	<ul style="list-style-type: none"> Decrease feed pressure/force Adjust side guide gap Use correct size blade Check clamping pressure Check coolant nozzles Check blade tension
 <p>Irregular Break Indicates material movement</p>	<ul style="list-style-type: none"> Indexing out of sequence Material loose in vise 	<ul style="list-style-type: none"> Check proper machine movement Check vise or clamp 	 <p>Blade Wear Teeth blued</p>	<ul style="list-style-type: none"> Incorrect blade Incorrect feed or speed Improper or insufficient coolant "Blueing" caused by excessive heat 	<ul style="list-style-type: none"> Use coarser tooth pitch Use correct feed and speed Check coolant flow Check coolant flow

BLADE OPTIMIZATION

USING METAL CHIPS TO TROUBLESHOOT

You can improve the productivity of your metal cutting operation by paying close attention to the chips made by the blade cutting through metal. This chart shows some of the common problems that can be discovered and solved by paying attention to chips in a large variety of materials.

Chip Form	Chip Condition	Chip color	Blade Speed	Blade Feed Rate	Other
	Thick, Hard and Short	Blue or Brown	Decrease ↓	Decrease ↓	Check Cutting Fluid and Mix
	Thin and Curled	Silver	Suitable ✓	Suitable ✓	
	Powder	Silver	Decrease ↓	Increase ↑	
	Thin and Tightly Curled	Silver	Suitable ✓	Decrease ↓	Check Tooth Pitch

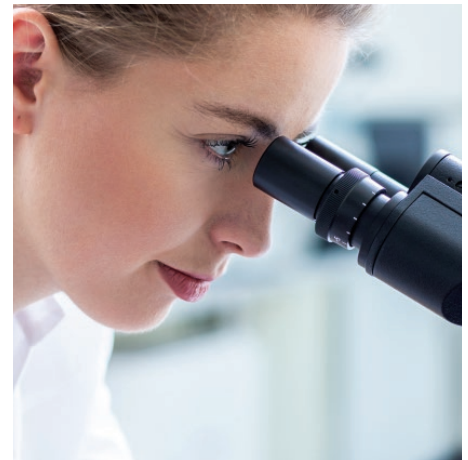

Blade Break-In

BLADE BREAK-IN: EXTREMELY IMPORTANT FOR MOST BLADES

The extremely sharp tooth points and edges of new blades must be broken-in before applying full feed pressure to the blade.

A good analogy is that of writing with a freshly sharpened wooden pencil.

**** Carbide Tipped band saw blades are the exception and should not be broken in ****

RECOMMENDED BREAK-IN PROCEDURE

- Maintain proper blade speed for the material to be cut.
- Reduce blade feed pressure or feed rate by 50% for the first 50 – 100in² or 322 – 645cm² of material cut.
- Gradually increase feed pressure or feed rate after break-in to target pressure or rate.

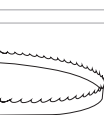

ANATOMY OF A SAW BLADE

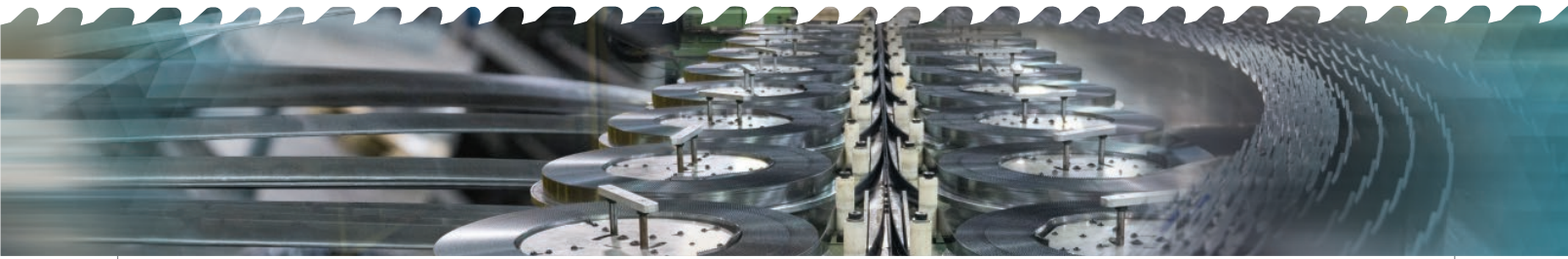

Although it looks like a flat piece of metal with teeth, a quality industrial band saw blade is actually a sophisticated cutting tool. Its ability to efficiently cut through tough metals, composite materials, plastics, and woods depends on a variety of interrelated factors such as the design, spacing and set of the teeth, the design and capacity of the gullets to make sure chips are efficiently removed, the composition of the backer strip, and the gage of the metal. These considerations must be taken into account when selecting the right blade for your application. The following Technical Pages will help you arrive at the perfect Morse solution to your particular cutting problem.

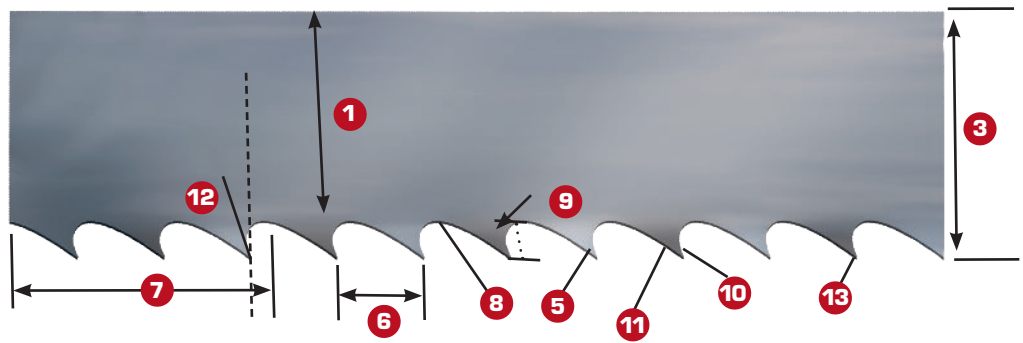
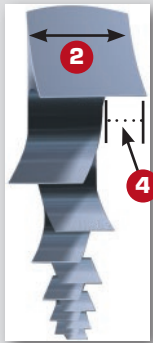

- 1 Blade Backer** The body of the blade not including tooth portion
- 2 Gauge**..... The thickness of the blade
- 3 Width**..... The tip of tooth to back of blade
- 4 Set**..... The positioning of teeth right or left
- 5 Tooth** The cutting portion of the saw blade
- 6 Tooth Pitch**..... The distance from one tooth tip to the next
- 7 T.P.I.** The number of teeth per inch measured gullet to gullet
- 8 Gullet** The curved area between the tooth points
- 9 Gullet Depth** The distance from the tooth tip to the bottom of the gullet
- 10 Tooth Face**..... The surface of the tooth on which the chip is formed
- 11 Tooth Flank** The angled back surface of the tooth opposite the tooth face
- 12 Tooth Rake Angle** The angle of the tooth face measured with respect to a line perpendicular to the cutting direction of the saw
- 13 Tooth Tip**..... The cutting edge of the saw tooth



TOOTH SET SPECIFICATIONS

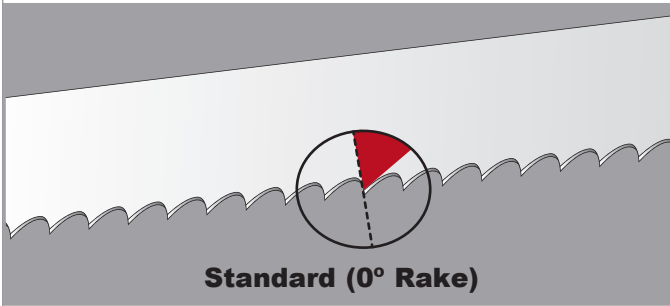

Standard (0° Rake)

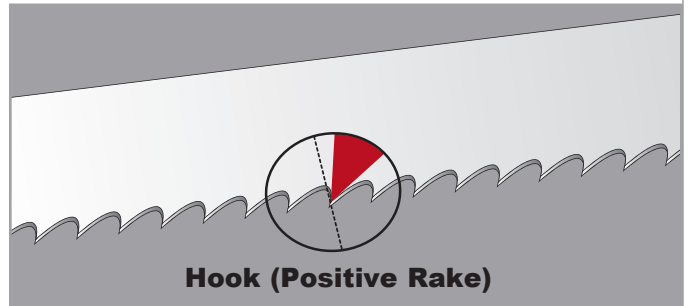

Hook (Positive Rake)

Here's where the blade makes the cut. The tooth design variables include shape, position, set, type and spacing. The combination of these variables will determine whether the blade can move easily through your material without binding or becoming clogged with chips.

Raker

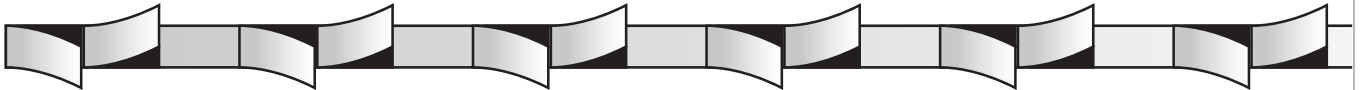

Recurring sequence of teeth - one set right, one set left, and one unset.

Modified Raker (double set raker)



Recurring sequence set left, right, left, right, straight tooth pattern.

Variable Pitch Modified Raker

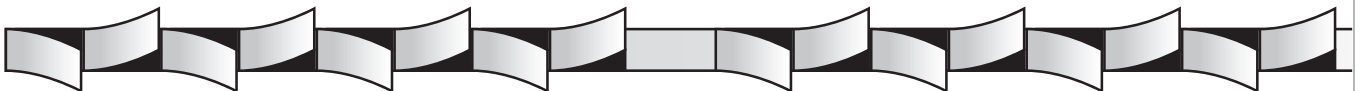

Set sequence depends on the number of teeth in the variable pitch tooth pattern.
Recurring sequence with more than two set teeth before an unset tooth.

Wavy







Groups of teeth, usually 3 or 4, set to each side in a controlled pattern with an unset tooth between groups.

Alternate (ETS)

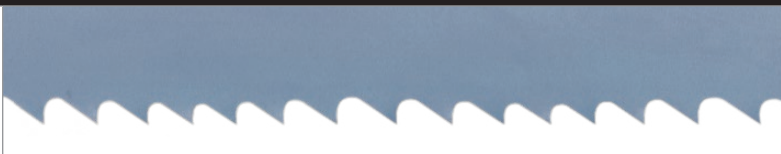

Every tooth set alternately to the left and right.

BAND SAW TOOTH PITCHES

Variable Pitch - 0°	
Feature <ul style="list-style-type: none"> ▼ Varying gullet depth ▼ 0° Rake angle ▼ Variable tooth spacing 	
Benefit <ul style="list-style-type: none"> ▼ Excellent chip carrying capacity ▼ Reduces harmonic vibration ▼ Cuts smoother and more efficiently 	Value <ul style="list-style-type: none"> ▼ Improves blade life ▼ Reduces noise ▼ Eliminates secondary operations, improves productivity
Variable Pitch Positive Rake	
Feature <ul style="list-style-type: none"> ▼ Varying gullet depth ▼ Variable tooth spacing ▼ Positive rake angle 	
Benefit <ul style="list-style-type: none"> ▼ Better chip formation ▼ Excellent chip carrying capacity ▼ Reduces harmonic vibration ▼ More aggressive cutting; better tooth penetration 	Value <ul style="list-style-type: none"> ▼ Cuts smoother, faster ▼ Improves productivity ▼ Reduces noise levels ▼ Generates less heat, improves blade life
Standard Raker	
Feature <ul style="list-style-type: none"> ▼ Equally spaced teeth ▼ 0° Rake angle 	
Benefit <ul style="list-style-type: none"> ▼ Excellent chip carrying capacity 	Value <ul style="list-style-type: none"> ▼ Increased productivity, versatility
Skip	
Feature <ul style="list-style-type: none"> ▼ Wide flat gullets ▼ 0° Rake angle ▼ Equally spaced teeth 	
Benefit <ul style="list-style-type: none"> ▼ Excellent chip carrying capacity ▼ Non-metallic, non-ferrous cutting applications (wood, plastic, brass, copper, bronze, and aluminum) 	Value <ul style="list-style-type: none"> ▼ Breaks "stringy" chips; improves cutting capability ▼ Greater productivity for specific applications
Hook	
Feature <ul style="list-style-type: none"> ▼ Wide rounded gullets ▼ Equally spaced teeth ▼ Positive rake angle 	
Benefit <ul style="list-style-type: none"> ▼ Excellent chip carrying capacity in non-metallic applications ▼ Positive rake provides better tip penetration with less feed pressure 	Value <ul style="list-style-type: none"> ▼ Better cutting performance, productivity ▼ Good surface finish to eliminate secondary operations



BLADE RECOMMENDATION CHECKLIST



After completing the checklist, please see product chart on back page or
Contact Morse Technical Assistance
 Complete and Fax to: 1(330) 453-1111
 or call 1(330) 453-8187 or visit www.bladewizard.com

Complete by: _____

Date: _____

User Information

Company: _____

Address: _____

Contact: _____

Phone No.: _____

Distributor Information

Company: _____

Address: _____

Contact: _____

Phone No.: _____

Fax No.: _____

e-mail: _____

Current Blade Information

Manufacturer: _____

Length: _____

Width: _____

Thickness: _____

Tooth Pitch: _____

Type: Carbon Matrix M42 Other

Monthly blade usage: _____

Current blade distributor: _____

Current blade cost: \$ _____ (ea.)

Machine Information

Make: _____

Model: _____

Vertical Horizontal

Blade Speed (sfm): _____

Feed Rate: _____

Application Information

Solid Square



Solid Round

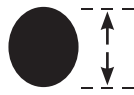

I-Beam



Angle Iron



Channel Iron



Round Tubing



Square Tubing



On the lines provided below each icon, list material width and wall thickness (if applicable) for each material type being cut

Types of Cutting

(Check all that apply)

Single Piece Cut-off

Bundled Cut-off

1. Number of pieces: _____

2. Check each configuration that applies:



Materials Being Cut

(Check all that apply)

Type

Grade

Non-Ferrous

Mild Carbon Steels

Tool Steels

Stainless Steels

Super Alloys

Other

Production Usage (per day)

Light (2 hrs. or less)

Medium (3-6 hrs.)

Heavy (7 hrs. or more)

Problems with Present Blade

Breaking blades

Premature dulling

Tooth strippage

Cost

Blade Recommendation





THIN KERF INDUSTRIAL **CIRCULAR SAW BLADES**

Blade Type

Application

Metal

Revolution FS

Optimized for carbon and high alloy steels.

Revolution

Optimized for stainless steel, high alloy steel, and aluminum.



REVOLUTION



Cut through steel, carbon, stainless, aluminum, and high alloy steel faster than ever. Unique combinations of metallurgy and blade configurations are tailored for peak performance in specific applications.

MADE IN U.S.A.



Features & Benefits

- ▼ Ferrous and non-ferrous metal cutting
- ▼ Efficient cutting for ½ to 6 inch diameter
- ▼ Most effective in solids

THIN KERF CIRCULAR SAW BLADES PROVIDE THE ULTIMATE PERFORMANCE IN CUTTING SOLUTIONS FOR HIGH VOLUME CUTTING

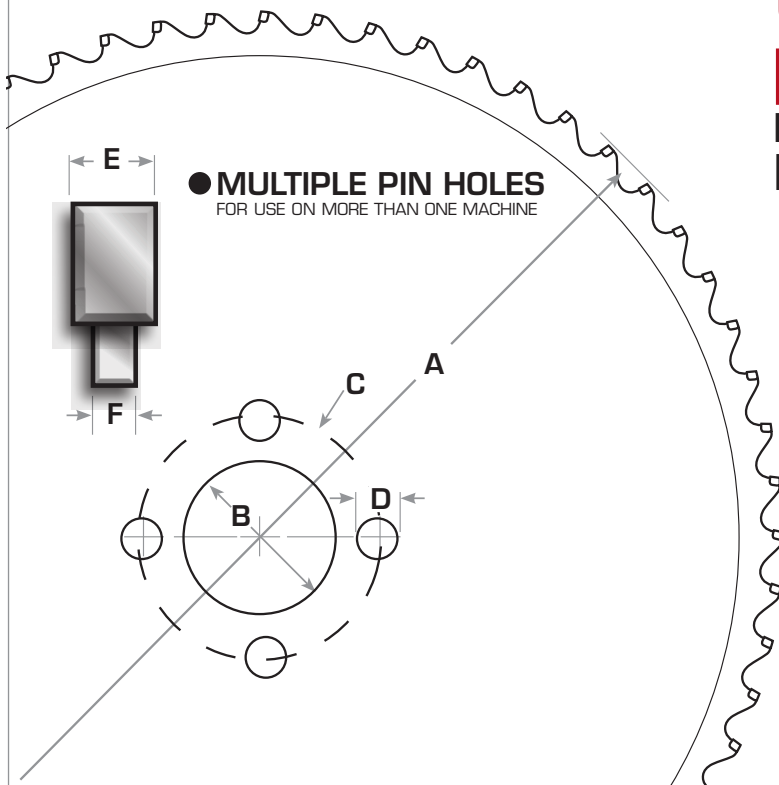

- A BLADE DIAMETER
- B ARBOR DIAMETER
- C PIN HOLE
- D PIN HOLE DIAMETER
- E KERF WIDTH
- F PLATE THICKNESS



METAL REVOLUTION FS



REVOLUTION FS Z BALANCE TECHNOLOGY



REVOLUTION FS

Revolution FS circular saw blades with patent-pending Z Balance technology are specifically engineered for use with industrial circular saw machines. These blades outperform the competition in a wide variety of applications from ½ to 6 inches depending on the machine model and blade diameter.

Applications

- ▼ Low and medium alloy steels
- ▼ Solid bars
- ▼ Workpiece hardness up to 40 HRC

Benefits

- ▼ Fast cutting
- ▼ Long life
- ▼ Straight cutting
- ▼ Superior finish
- ▼ Consistent quality
- ▼ No resharpener

Diameter		Kerf (mm)	Teeth	Drive Pins	Model	Part	Machine Example
Blade (mm)	Inner (mm)						
250mm	32mm	2.0mm	72	4/11/63 and 4/9/50	ICTNK25072FSB	203159	Tsune Nishijimax Kasto (Wagner) Exact Cut
250mm	32mm	2.0mm	80		ICTNK25080FSB	203166	
285mm	32mm	2.0mm	60	4/11/63 and 4/9/50	ICTNK28560FSB	203173	Everising Kasto Nishijimax Tsune
285mm	32mm	2.0mm	72		ICTNK28572FSB	203180	
285mm	32mm	2.0mm	80		ICTNK28580FSB	203197	
360mm	40mm	2.74mm	60	4/11/90	ICAM36060FSB	203203	Amada Behringer Daito / Delta Everising Mega Missler
360mm	40mm	2.74mm	80		ICAM36080FSB	203210	
360mm	40mm	2.74mm	100		ICAM360100FSB	203227	
360mm	50mm	2.74mm	60	4/14/80 and 4/16/80	ICNT36060FSB	203234	Endo Kaltenbach Kasto Nishijimax Tsune
360mm	50mm	2.74mm	80		ICNT36080FSB	203241	
360mm	50mm	2.74mm	100		ICNT360100FSB	203258	
420mm	50mm	2.74mm	60	4/16/80	ICTS42060FSB	203265	Endo Tsune
420mm	50mm	2.74mm	80		ICTS42080FSB	203272	
460mm	50mm	2.74mm	60	4/16/80 and 4/21/90	ICNI46060FSB	203289	Amada Everising Nishijimax
460mm	50mm	2.74mm	80		ICNI46080FSB	203296	



METAL CARBIDE TIPPED



REVOLUTION

Morse Revolution blades are high performance circular saw blades specifically engineered for use with thin kerf metal cutting industrial circular saw machines. Optimized for stainless steel, high alloy steel, and aluminum. Made for cutting solids from 1/2 to 6 inches depending on machine model and blade diameter.

Applications

- ▼ Stainless steels
- ▼ High alloy steels
- ▼ Aluminum

Benefits

- ▼ Less material waste
- ▼ Consistent quality
- ▼ No resharpening
- ▼ Long life
- ▼ Fast cutting
- ▼ Superior finish

Diameter		Kerf (mm)	Teeth	Pin Hole	Model	Part	Machine Example
Blade (mm)	Inner (mm)						
285	32	2.03	80	4/11/63 and 4/9/50	ICTNK28580CB	203005	Everising Kasto Nishijimax Tsune
360	40	2.7	60	4/11/90	ICAM36060CB	203081	Amada Behringer Daito / Delta
360	40	2.7	80		ICAM36080CB	203029	Everising Mega
360	50	2.7	60		ICNT36060CB	203012	Kaltenbach Kasto Tsune
360	50	2.7	80	ICNT36080CB	203036		
360	50	2.7	100	ICNT360100CB	203074		
420	50	2.7	60	4/16/80	ICTS42060CB	203043	Endo Tsune
460	50	2.7	60	4/16/80 and 4/21/90	ICNI46060CB	203050	Amada Everising Nishijimax

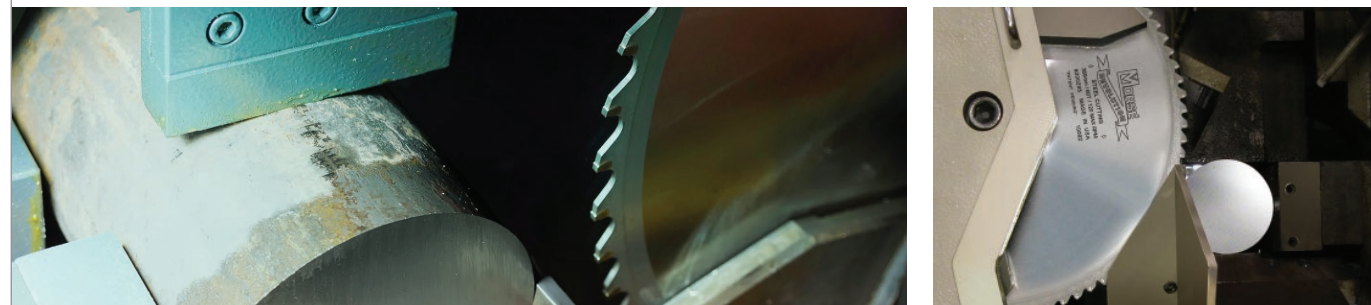

BLADE TYPE SELECTION GUIDE

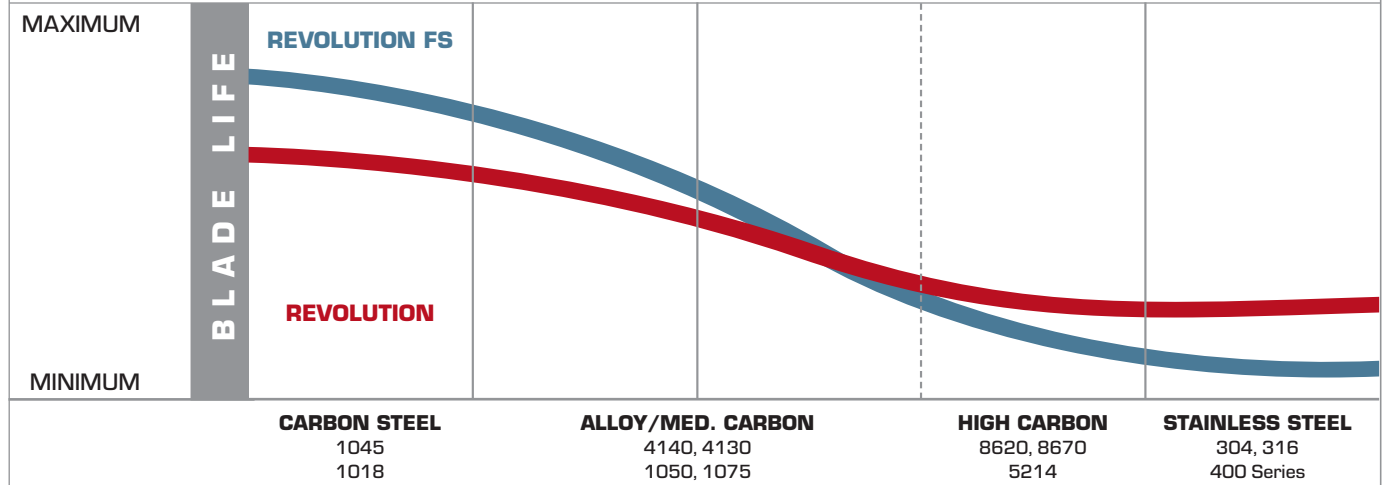

BLADE TOOTH SELECTION GUIDE

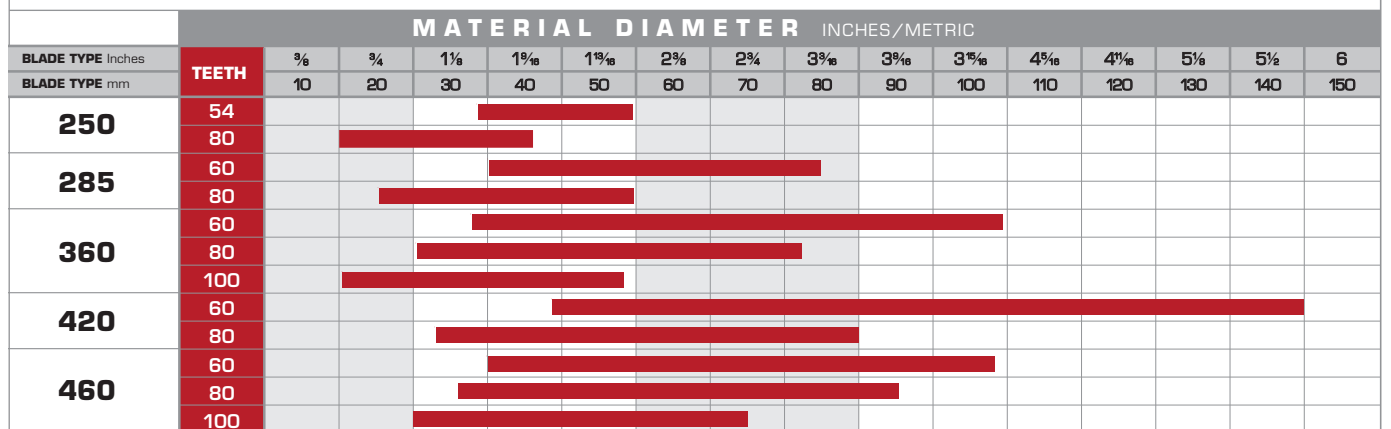

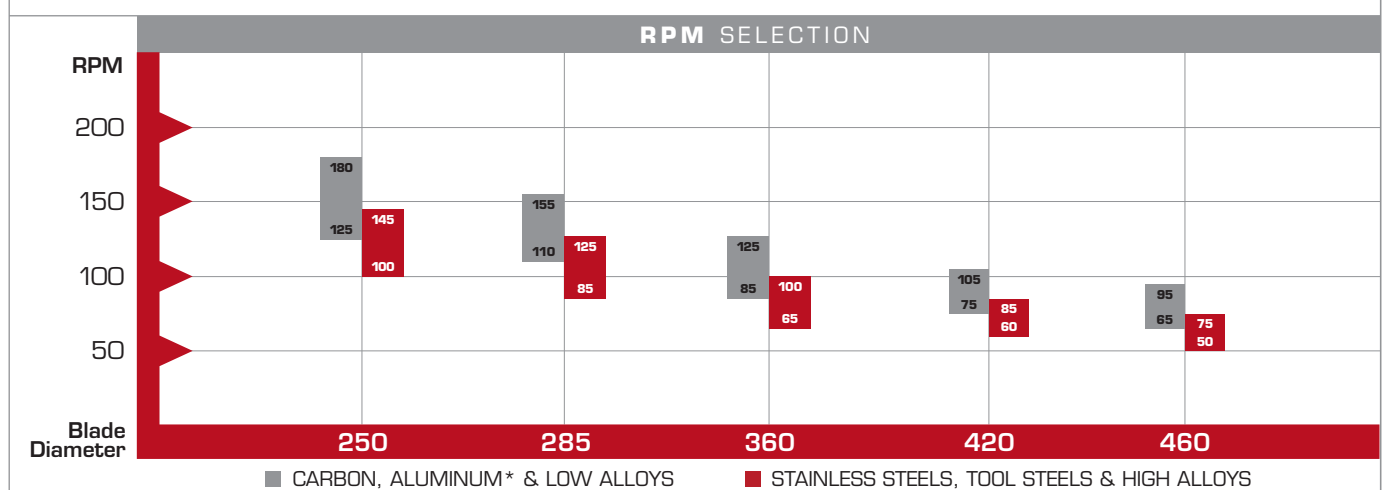

RPM SELECTION GUIDE

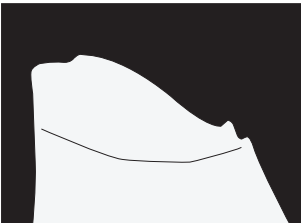

* For ALUMINUM, use Revolution at Revolution FS parameters

THIN KERF INDUSTRIAL CIRCULAR

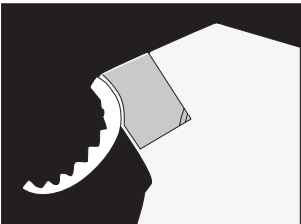
Problem	Problem Cause	Solution
Teeth stripping 	Incorrect blade selection	Select a blade with larger gullet space Select a blade with fewer teeth
	Excessive cutting speed	Refer to the cutting conditions chart Lower feed rate/chip load
	Excessive chip load	Refer to the cutting conditions chart Lower feed rate/chip load
	Excessive wear at the cutting edge	Check for the integrity of the chip groove Direct mist on to the cutting edge
	Low clamp/vice pressure/material moves	Increase hydraulic pressure up to specified level
Gullet clogging 	Incorrect blade selection	Select a blade with larger gullet space Select a blade with fewer teeth
	Insufficient coolant	Increase coolant rate until cut surface is wet
	Incorrect tooth type for material being cut	Select correct tooth type
Chip welding 	Incorrect cutting parameters	Check RPM Check chip load
	Insufficient coolant	Check coolant rate Increase coolant rate Check orientation of outlet nozzle Check chip brush Adjust or replace chip brush if necessary
	Damaged teeth	Check the tooth for damage Run if necessary at reduced chip load/feed rate
	Excessive wear at the tooth edge	Increase coolant and air flow Run at low RPM and chip load/feed rate
Out of square cuts	High or low plate tension	Replace the blade
	Chamfer imbalance	Replace the blade
Billet weight inconsistent	Machine malfunction	Check/clean the feed sensors/inspect
Wavy Cuts	Low or high plate tension	Replace the blade
	Insufficient coolant	Check coolant flow
	Out of square clamping	Check cleanliness of jaws/vice Check squareness of jaws/vice Check feeding mechanism and sensors

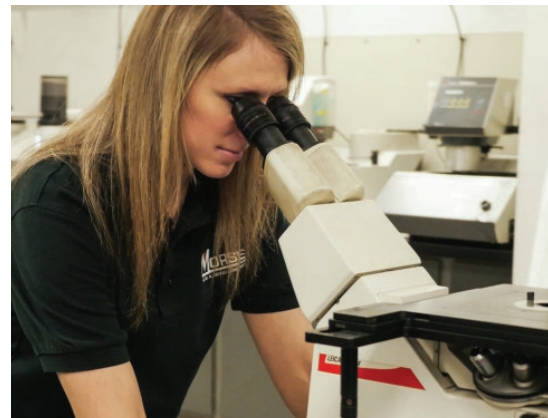
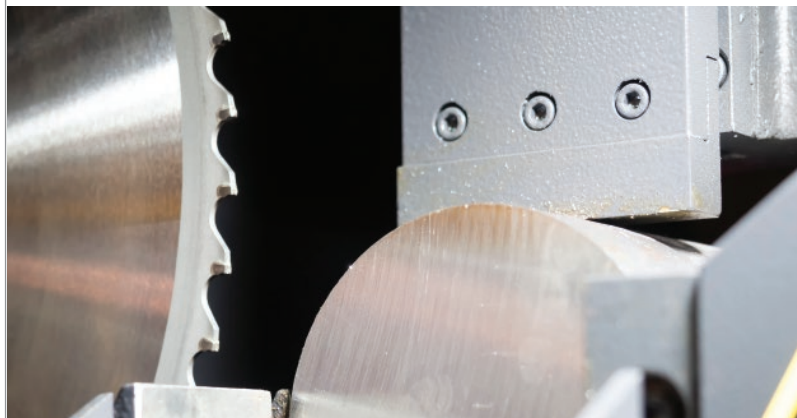



MORSE HOLE CUTTING & BORING TOOLS

Blade Type Application

Hole Saws

General Purpose

Bi-Metal MHS/ MHSA General purpose cutting across a wide range of materials including metals, wood, drywall and composites.

Fast Adapt Arbors Compatible across the range of hole saws. For contractors who need to quickly change from one hole saw to another, including electrical, plumbing, siding, door, flooring and marine.

Arbors & Accessories Compatible across the range of hole saws. Accessories include extensions that allow you to increase the reach of the saw, adapters that facilitate hole enlargement, springs to facilitate slug removal and replacement pilot drills.

Carbide Tipped MHSTK Extended life cutting fiberglass, nail-free wood, fiberboard, stainless steel, drywall, plaster and laminates. Not recommended for pipe cutting.

Specialty

Diamond Grit For use on extremely hard or abrasive materials where cut finish is important including stone, porcelain/ceramics, brick/masonry, cast iron, glass block, architectural stone, composites and laminate flooring.

Carbide Grit For use on hard or abrasive materials including cement, brick, cinder block, cast iron, plaster with lath, unglazed ceramics, fiberglass, and composites.

Recessed Lighting Grit saws are ideal for installations in drywall, plaster with lath or ceiling tile. Bi-metal saws are designed for installations in metal or wood.

Precision Hole Cutting

Metal

CT Hole Cutters Precision cutting for fabrication applications. Makes clean, fast cuts in sheet metal, stainless steel, pipe, conduit, aluminum and composites.

Step Drills Repetitive hole cutting or enlargement for electrical, automotive and sheet metal applications.

Wood Hole Cutting

Double Cut Auger Bits Excellent for deep boring in wood and nail-embedded wood. Applications include landscaping timbers, log and timber frame construction, plumbing and electrical installations.

Spade Bits Fast, deep cutting in wood, plywood, composites and laminates.

HOLE SAWS GENERAL PURPOSE

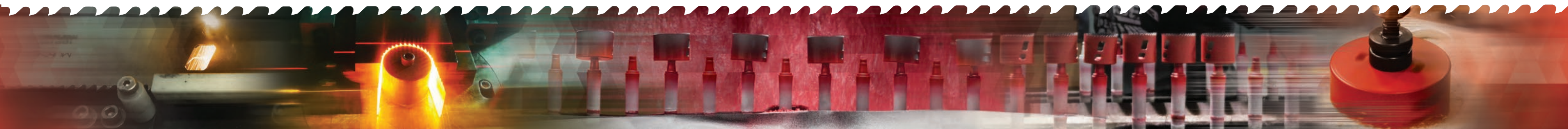

BI-METAL MHS / MHS A

General purpose cutting across a wide range of materials including metals, wood, drywall and composites.

Applications

- ▼ Wood
- ▼ Plastic
- ▼ Machinable metals
- ▼ Stainless steel alloys
- ▼ Nail-embedded wood

Benefits

- ▼ Optimized to remove material faster
- ▼ Solid cap reduces runout and vibration
- ▼ Premium high speed steel
- ▼ 1¹/₈ (49 mm) cutting depth
- ▼ New side slot for increased leverage for faster, easier slug removal



Diameter		MHS (1/2 – 20 arbor required)						MHS A (arbor attached)	
		Model	Part	Model	Part	Model	Part	Model	Part
in	mm	1/Box		1/Card		Bulk 25/Box		1/Card	
5/16	14	MHS09	177092	MHS09C	178099			MHSA09C	116091
3/8	16	MHS10	177108	MHS10C	178105			MHSA10C	116107
1/4	17	MHS11	177115	MHS11C	178112	MHS11B25	189118	MHSA11C	116114
3/4	19	MHS12	177122	MHS12C	178129	MHS12B25	189125	MHSA12C	116121
	20	MHS125	177559	MHS125C	178556	MHS125B25	189132	MHSA125C	116688
13/16	21	MHS13	177139	MHS13C	178136	MHS13B25	189156	MHSA13C	116138
7/8	22	MHS14	177146	MHS14C	178143	MHS14B25	189149	MHSA14C	116145
15/16	24	MHS15	177153	MHS15C	178150			MHSA15C	116152
1	25	MHS16	177160	MHS16C	178167	MHS16B25	189163	MHSA16C	116169
1 1/16	27	MHS17	177177	MHS17C	178174	MHS17B25	189170	MHSA17C	116176
1 1/8	29	MHS18	177184	MHS18C	178181	MHS18B25	189187	MHSA18C	116183
1 3/16	30	MHS19	177191	MHS19C	178198	MHS19B25	189194	MHSA19C	116190
		MHS (5/8 – 18 arbor required)						MHS A (arbor attached)	
1 1/4	32	MHS20	177207	MHS20C	178204	MHS20B25	189200	MHSA20C	116206
1 5/16	33	MHS21	177214	MHS21C	178211	MHS21B25	189217	MHSA21C	116213
1 3/8	35	MHS22	177221	MHS22C	178228	MHS22B25	189224	MHSA22C	116220
1 7/16	37	MHS23	177238	MHS23C	178235			MHSA23C	116237
1 1/2	38	MHS24	177245	MHS24C	178242	MHS24B25	189248	MHSA24C	116244
1 9/16	40	MHS25	177252	MHS25C	178259			MHSA25C	116251
1 5/8	41	MHS26	177269	MHS26C	178266	MHS26B25	189262	MHSA26C	116268
1 11/16	43	MHS27	177276	MHS27C	178273	MHS27B25	189279	MHSA27C	116275
1 3/4	44	MHS28	177283	MHS28C	178280	MHS28B25	189286	MHSA28C	116282
	45	MHS285	177740	MHS285C	178747			MHSA285C	116770
1 13/16	46	MHS29	177290	MHS29C	178297			MHSA29C	116299
1 7/8	48	MHS30	177306	MHS30C	178303	MHS30B25	189309	MHSA30C	116305

Diameter		MHS (5/8 – 18 arbor required)						MHS A (arbor attached)	
		Model	Part	Model	Part	Model	Part	Model	Part
in	mm	1/Box		1/Card		Bulk 25/Box		1/Card	
	50	MHS315	177313	MHS315C	178310			MHSA315C	116787
2	51	MHS32	177320	MHS32C	178327	MHS32B25	189323	MHSA32C	116329
2 1/16	52	MHS33	177337	MHS33C	178334			MHSA33C	116336
2 1/8	54	MHS34	177344	MHS34C	178341	MHS34B25	189347	MHSA34C	116343
	55	MHS345	177351	MHS345C	178358			MHSA345C	116794
2 1/4	57	MHS36	177368	MHS36C	178365	MHS36B25	189361	MHSA36C	116367
2 5/16	59	MHS37	177375	MHS37C	178372			MHSA37C	116374
2 3/8	60	MHS38	177382	MHS38C	178389	MHS38B25	189385	MHSA38C	116381
	62	MHS385	177399	MHS385C	178396				
2 1/2	64	MHS40	177405	MHS40C	178402	MHS40B25	189408	MHSA40C	116404
2 5/8	65	MHS41	177412	MHS41C	178419	MHS41B25	189415	MHSA41C	116411
2 3/4	67	MHS42	177429	MHS42C	178426	MHS42B25	189422	MHSA42C	116428
	68	MHS425	177436	MHS425C	178433			MHSA425C	116817
2 3/4	70	MHS44	177443	MHS44C	178440			MHSA44C	116442
2 7/8	73	MHS46	177467	MHS46C	178464			MHSA46C	116466
	75	MHS475	177474	MHS475C	178471			MHSA475C	116831
3	76	MHS48	177481	MHS48C	178488	MHS48B25	189484	MHSA48C	116480
3 1/8	79	MHS50	177504	MHS50C	178501			MHSA50C	116503
3 1/4	83	MHS52	177528	MHS52C	178525			MHSA52C	116527
3 3/8	86	MHS54	177542	MHS54C	178549			MHSA54C	116541
3 1/2	89	MHS56	177566	MHS56C	178563			MHSA56C	116565
3 5/8	92	MHS58	177580	MHS58C	178587			MHSA58C	116589
3 3/4	95	MHS60	177603	MHS60C	178600			MHSA60C	116602
3 7/8	98	MHS62	177627	MHS62C	178624			MHSA62C	116626
	100	MHS63	177634	MHS63C	178631			MHSA63C	116633
4	102	MHS64	177641	MHS64C	178648			MHSA64C	116640
4 1/8	105	MHS66	177665						
4 1/4	108	MHS68	177689						
4 3/8	111	MHS70	177702						
4 1/2	114	MHS72	177726						
4 3/4	121	MHS76	177764						
	127	MHS80	177801						
5 1/4	133	MHS84	177849						
5 1/2	140	MHS88	177887						
5 3/4	146	MHS92	177924						
	152	MHS96	177962						
6 3/8	162	MHS104	177498						
6 5/8	168	MHS106	177535						

Items noted in **BOLD** also available in kits. See pages 58-59.

RPM recommendations provided on page 60. **Pipe entrance and pipe tap recommendations** provided on page 61.

HOLE SAW ACCESSORIES



FAST ADAPT® ARBORS

Compatible across the range of hole saws. For contractors who need to quickly change from one hole saw to another, including electrical, plumbing, siding, door, flooring and marine.



Fast Adapt	Image	Shank	Chuck	Thread	Fits Saws	Follow Through	Standard Pilot	
							Model	Part
Universal Arbor		7/16 3-sided	1/2		5/16 - 63/16	1 1/2	MQRAC	143042
Fast Adapt - 1/2				1/2 - 20	5/16 - 1 3/16	1 1/2	5/Card	
Fast Adapt - 5/8				5/8 - 18	1 1/4 - 6 3/8	1 1/2	MQR58C	143011
Fast Adapt Combo Pack - 2 MQR12 / 3 MQR58				1/2 - 20 5/8 - 18	5/16 - 6 3/8	1 1/2	MQR5812C	143004
Pilot Drill							1/Card	
							MQRPDC	143035

Pilot Drills	Image	Length		Diameter		Model	Part	Model	Part
		in	mm	in	mm				
Items noted in BOLD also available in kits. See pages 58-59.									
MHS, MHSA, MHSTK and MHSB Hole Saws									
Standard		3 3/32	79	1/4	6	MAPD301	139113	MAPD3C	139212
Carbide Tipped		3 3/32	79	1/4	6	MAPD3CT	139229		
AV, MK, TA, TAD and AD Hole Saws									
Standard		3 1/16	78	1/4	6	MPD4S01	140799		
Standard		4 5/16	110	1/4	6	MPD401	140775		
Carbide Tipped		2 7/8	73	1/4	6	MPD4SCT01	140874		

Extensions	Image	Length		Shank		Chuck	Model	Part	Model	Part	Model	Part
		in	mm	in	mm							
		12	305	3/8 Hex	9.5	3/8	ME381	140409			ME38	901991
		12	305	7/16 Hex	10.5	1/2	ME121	141123	ME1210	142120	ME12	140126

ARBORS & ACCESSORIES

Compatible across the range of hole saws. Accessories include extensions that allow you to increase the reach of the saw, adapters that facilitate hole enlargement, springs to facilitate slug removal and replacement pilot drills.



Arbors	Image	Shank	Chuck	Thread	Fits Saws	Follow Through	Standard Pilot		Carbide Tipped Pilot			
							Model	Part	Model	Part		
Items noted in BOLD also available in kits. See pages 58-59.												
Standard												
	1/4 Hex	1/4	1/2 - 20	5/16 - 1 3/16	3/4		MA24	139007	MA24C	139618		
	3/8 Hex	3/8	1/2 - 20	5/16 - 1 3/16	3/4		MA34	139014	MA34C	139625	MA34CT	139809
	3/8 Hex	3/8	5/8 - 18	1 1/4 - 6 3/8	3/4		MA35	139045	MA35C	139632		
Pinned												
	3/8 Hex	3/8	5/8 - 18	1 1/4 - 6 3/8	1 1/2		MA35PS	139021	MA35PSC	139649	MA35PSCT	139823
	7/16 Hex	1/2	5/8 - 18	1 1/4 - 6 3/8	1 1/2		MA45PS	139038	MA45PSC	139656	MA45PSCT	139816

Pilot Drills	Image	Model	Part	Model	Part	Model	Part	Packaging	
								10/Pack	25/Box
MHS, MHSA, MHSTK and MHSB Hole Saws									
		MAPD310	139120	MAPD325	139137	MAPD3100	139144		
AV, MK, TA, TAD and AD Hole Saws									
		MPD4S10	140683	MPD4S25	140720	MPD4S100	140690		
		MPD410	140478	MPD425	140522	MPD4100	140492		



Accessories	Image	Thread		Model	Part	Model	Part	Model	Part	Model	Part
		Arbor	Saw								
Hole Saws											
Hex Adapter		1/2 - 20	3/8 - 18	M44NH01	140744	M44NH05	140584				
Ejector Spring - fits 1/4 Pilot Drills				MES101	140805	MES105	140812			MES125	140836
Set Screw - Pinned Arbor (MA35PS, MA45PS)								MASS1110	141086		
Set Screw - Unpinned Arbor (MA24, MA34, MA35)								MASS1010	141079		
Set Screw - Extensions								MESS0310	141017		

HOLE SAWS GENERAL PURPOSE



KRAKEN CARBIDE TIPPED

Kraken is a new and improved carbide tipped hole saw with patent pending tooth design. Use in a wide variety applications and industries to fulfill all your cutting needs; now including fastener embedded wood!

Applications

- ▼ Fiberglass
- ▼ Plastic
- ▼ Composites
- ▼ Aluminum
- ▼ Carbon Steel
- ▼ Computer Flooring
- ▼ Fastener Embedded Wood
- ▼ Stainless Steel
- ▼ Tile Backer

Benefits

- ▼ New patent pending tooth provides:
 - Faster cutting in all applications
 - Better chip clearance for longer life
 - Smaller slug dimensions for easier slug removal
 - Smoother entry cut resulting in less torque
- ▼ New side slot provides increased leverage for faster, easier slug removal
- ▼ 1⁵/₁₆" (49 mm) cutting depth for a wider variety of materials and applications

Arbor Required:
 5/16" – 1³/₁₆" use 1/2" – 20
 1¹/₄" – 6" use 3/8" – 18



Diameter		Model	Part	Diameter		Model	Part	Diameter		Model	Part
in	mm	1/Box		in	mm	1/Box		in	mm	1/Box	
9/16	14	MHSTK09	131094	1 ¹ / ₈	41	MHSTK26	131261	3 ¹ / ₄	83	MHSTK52	131520
—	16	MHSTK105	131100	1 ¹¹ / ₁₆	43	MHSTK27	131278	3 ³ / ₈	86	MHSTK54	131544
1 ¹ / ₁₆	17	MHSTK11	131117	1³/₄	44	MHSTK28	131285	3 ¹ / ₂	89	MHSTK56	131568
3 / ₄	19	MHSTK12	131124	1 ¹³ / ₁₆	46	MHSTK29	131292	3 ⁵ / ₈	92	MHSTK58	131582
—	20	MHSTK125	131971	1 ⁷ / ₈	48	MHSTK30	131308	3 ³ / ₄	95	MHSTK60	131605
1 ³ / ₁₆	21	MHSTK13	131131	2	51	MHSTK32	131322	3 ⁷ / ₈	98	MHSTK62	131629
7 / ₈	22	MHSTK14	131148	2 ¹ / ₁₆	52	MHSTK33	131339	4	102	MHSTK64	131643
1 ⁵ / ₁₆	24	MHSTK15	131155	2 ¹ / ₈	54	MHSTK34	131346	4 ¹ / ₈	105	MHSTK66	131667
1	25	MHSTK16	131162	2¹/₄	57	MHSTK36	131360	4 ¹ / ₄	108	MHSTK68	131681
1 ¹ / ₁₆	27	MHSTK17	131179	2 ⁵ / ₁₆	59	MHSTK37	131377	4 ³ / ₈	111	MHSTK70	131704
1¹/₈	29	MHSTK18	131186	2 ³ / ₈	60	MHSTK38	131384	4 ¹ / ₂	114	MHSTK72	131728
1 ³ / ₁₆	30	MHSTK19	131193	2¹/₂	64	MHSTK40	131407	4 ³ / ₄	121	MHSTK76	131766
1 ¹ / ₄	32	MHSTK20	131209	2 ⁹ / ₁₆	65	MHSTK41	131414	5	127	MHSTK80	131803
1 ⁵ / ₁₆	33	MHSTK21	131216	2 ⁵ / ₈	67	MHSTK42	131421	5 ¹ / ₄	133	MHSTK84	131841
1³/₈	35	MHSTK22	131223	2 ³ / ₄	70	MHSTK44	131445	5 ¹ / ₂	140	MHSTK88	131889
1 ⁷ / ₁₆	37	MHSTK23	131230	2 ⁷ / ₈	73	MHSTK46	131469	5 ³ / ₄	146	MHSTK92	131926
1¹/₂	38	MHSTK24	131247	3	76	MHSTK48	131483	6	152	MHSTK96	131964
1 ⁹ / ₁₆	40	MHSTK25	131254	3 ¹ / ₈	79	MHSTK50	131506				

Items noted in **BOLD** also available in kits. See pages 58-59.
 RPM recommendations provided on page 60.
 Pipe entrance and pipe tap recommendations provided on page 61.



HOLE SAWS SPECIALTY

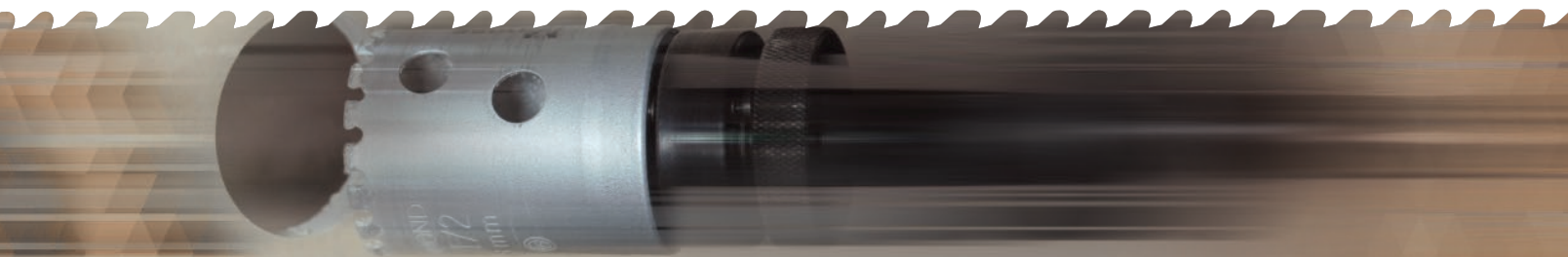

DIAMONDGRIT™

DIAMOND GRIT

For use on extremely hard or abrasive materials where cut finish is important including stone, porcelain/ceramics, brick/masonry, cast iron, glass block, architectural stone, composites and laminate flooring.

Applications

- ▼ Granite (stone)
- ▼ Ceramic Tile
- ▼ Glass Block
- ▼ Brick (masonry)
- ▼ Cast Iron
- ▼ Laminate Flooring

Benefits

- ▼ Industrial Diamond Grit brazed to hardened and tempered alloy body.
- ▼ Fast and easy cutting of abrasive materials.
- ▼ Finish cut edges are smooth and clean.
- ▼ Hollow core center keeps hole saw centered
- ▼ Side slots allow for fast removal of material



Auto-Pilot
recommended for
Standard Hole Saws

Diameter		One-piece Hole Saws (arbor attached)		Standard Hole Saws (arbor required)	
		Model	Part	Model	Part
in	mm	1/Card		1/Card	
3/16	5	DGM03C	129152		
1/4	6	DGM04C	129169		
5/16	8	DGM05C	129176		
3/8	10	DGM06C	129183		
1/2	13	DGM08C	129190		
5/8	16	DGM10C	129206		
3/4	19	DGM12C	129213		
7/8	22			DG14C	129008
1	25	DGM16C	129220		
1 1/8	29			DG18C	129015
1 1/4	32			DG20C	129022
1 3/8	35	DGM22C	129237		
2	51			DG32C	129039
2 1/2	64			DG40C	129046

Auto-Pilot		DGAPC	129503
------------	---	-------	--------



Arbor required for Standard Hole Saws:
3/8 – 1 1/8 use 1/2 – 20
1 1/4 – 2 1/2 use 3/8 – 18



HOLE SAWS SPECIALTY



TUNGSTEN CARBIDE GRIT

CARBIDE GRIT

For use on hard or abrasive materials including cement, brick, cinder block, cast iron, plaster with lath, unglazed ceramics, fiberglass, and composites.

Applications

- ▼ Acoustic tile
- ▼ Brick
- ▼ Cast iron
- ▼ Cement board
- ▼ Ceramics
- ▼ Cinderblock
- ▼ Composites
- ▼ Computer flooring
- ▼ Fiberglass
- ▼ Hardened steel
- ▼ Particleboard
- ▼ Asbestos board
- ▼ Formica

Benefits

- ▼ Super resistance to heat, wear and abrasion with shock resistant back
- ▼ Tungsten carbide grains are bonded to alloy backs with a gulleted snag resistant edge
- ▼ CT pilot drill recommended for masonry type materials



Arbor Required:
 $\frac{3}{16}$ - $1\frac{1}{16}$ use $\frac{1}{2}$ - 20
 $1\frac{1}{4}$ - 6 use $\frac{5}{8}$ - 18

Gulleted

Diameter		Model	Part	Diameter		Model	Part	Diameter		Model	Part
in	mm	1/Box		in	mm	1/Box		in	mm	1/Box	
$\frac{3}{4}$	19	MHSG12	216128	$1\frac{3}{4}$	44	MHSG28	216289	$3\frac{1}{4}$	83	MHSG52	216524
$1\frac{1}{16}$	21	MHSG13	216135	$1\frac{13}{16}$	46	MHSG29	216296	$3\frac{3}{8}$	86	MHSG54	216548
$\frac{7}{8}$	22	MHSG14	216142	$1\frac{1}{8}$	48	MHSG30	216302	$3\frac{1}{2}$	89	MHSG56	216562
$1\frac{5}{16}$	24	MHSG15	216159	2	51	MHSG32	216326	$3\frac{5}{8}$	92	MHSG58	216586
1	25	MHSG16	216166	$2\frac{1}{16}$	52	MHSG33	216333	$3\frac{3}{4}$	95	MHSG60	216609
$1\frac{1}{16}$	27	MHSG17	216173	$2\frac{1}{8}$	54	MHSG34	216340	$3\frac{7}{8}$	98	MHSG62	216623
$1\frac{1}{8}$	29	MHSG18	216180	$2\frac{1}{4}$	57	MHSG36	216364	4	102	MHSG64	216647
$1\frac{3}{16}$	30	MHSG19	216197	$2\frac{5}{16}$	59	MHSG37	216371	$4\frac{1}{8}$	105	MHSG66	216661
$1\frac{1}{4}$	32	MHSG20	216203	$2\frac{3}{8}$	60	MHSG38	216388	$4\frac{1}{4}$	108	MHSG68	216685
$1\frac{5}{16}$	33	MHSG21	216210	$2\frac{1}{2}$	64	MHSG40	216401	$4\frac{3}{8}$	111	MHSG70	216708
$1\frac{3}{8}$	35	MHSG22	216227	$2\frac{9}{16}$	65	MHSG41	216418	$4\frac{1}{2}$	114	MHSG72	216722
$1\frac{1}{16}$	37	MHSG23	216234	$2\frac{3}{8}$	67	MHSG42	216425	$4\frac{3}{4}$	121	MHSG76	216760
$1\frac{1}{2}$	38	MHSG24	216241	$2\frac{3}{4}$	70	MHSG44	216449	5	127	MHSG80	216807
$1\frac{1}{16}$	40	MHSG25	216258	$2\frac{1}{2}$	73	MHSG46	216463	$5\frac{1}{2}$	140	MHSG88	216883
$1\frac{3}{8}$	41	MHSG26	216265	3	76	MHSG48	216487	$5\frac{3}{4}$	146	MHSG92	216920
$1\frac{1}{16}$	43	MHSG27	216272	$3\frac{1}{8}$	79	MHSG50	216500	6	152	MHSG96	216968

Continuous

$6\frac{3}{8}$	162	MHSG104	216975
$6\frac{1}{8}$	168	MHSG106	216982
$6\frac{7}{8}$	174	MHSG110	216999



Items noted in **BOLD** also available in kits. See pages 58-59.
 RPM recommendations provided on page 60.
 Pipe entrance and pipe tap recommendations provided on page 61.



RECESSED LIGHTING HOLE SAW

RECESSED LIGHTING

Leave a clean cut for recessed light installation by selecting the right saw for the application. Carbide grit saws are best when installing in abrasive material like drywall, plaster and ceiling tile. For ceilings made of wood or metal, bi-metal hole saws are the best choice.

The lens diameter of the fixture provides a good indication of the hole size required. Consult the manufacturers installation instructions to confirm the hole size necessary to leave adequate clearance for the light assembly. The most popular sizes are provided below.

Applications

- Carbide Grit**
 - ▼ Drywall
 - ▼ Plaster
 - ▼ Lath
 - ▼ Ceiling Tile
- Bi-Metal**
 - ▼ Wood
 - ▼ Metal

Benefits

- ▼ Carbide grit saws leave clean cuts in abrasive materials like drywall, plaster and ceiling tile
- ▼ Bi-metal saws provide smooth cuts in wood or metal
- ▼ Application specific saws extend blade life
- ▼ Standard pilot drill recommended for most applications. CT pilot drill recommended for masonry type applications.

Arbor Required: $5/8$ - 18



Lighting Fixture Lens		Hole Saw		Best for Drywall, Plaster, Lath and Ceiling Tile		Best for Wood or Metal	
Diameter		Diameter		1/Box		1/Box	
in	mm	in	mm	Model	Part	Model	Part
				Gulleted Carbide Grit			
2	51	$2\frac{1}{8}$	60	MHSG38	216388	MHS38	177382
3	76	$3\frac{1}{8}$	86	MHSG54	216548	MHS54	177542
4	102	$4\frac{1}{8}$	111	MHSG70	216708	MHS70	177702
5	127	$5\frac{1}{2}$	140	MHSG88	216883	MHS88	177887
				Continuous Carbide Grit			
6	152	$6\frac{3}{8}$	162	MHSG104	216975	MHS104	177498
6	152	$6\frac{1}{8}$	168	MHSG106	216982	MHS106	177535
6	152	$6\frac{7}{8}$	174	MHSG110	216999		
				Bi-Metal			

RPM recommendations provided on page 60.
 Pipe entrance and pipe tap recommendations provided on page 61.



HOLE SAW KITS



			Electrician's Kits				Plumber's Kits			Industrial Kits						Automotive	Locksmith	General Purpose	
Component	Size		MHSELE01 177894	MHS08E 177757	MHS02E 177771	MHSTK02E 131025	MHSPLU01 177900	MHS16P 177818	MHS04P 177795	MHS23M 177788	MHS06I 177870	MHS08I 177863	MHS100 177825	MHSTK100 131001	MHSG100 162005	MHS05M 116916	MHS02L 177856	MHSALKIT1 116909	MHS03U 177832
	in	mm																	
MHS Bi-Metal Hole Saws	3/4	19	1				1	1	1										
	7/8	22	1	1	1		1	1	1							1	1		1
	1	25	1													1	1	1	
	1 1/8	29	1	1	1		1	1	1										1
	1 1/4	32	1																
	1 3/8	35	1	1	1														
	1 1/2	38	1				1	1	1										1
	1 3/4	44	1	1	1		1	1	1										1
	2	51	1	1	1														
	2 1/8	54					1												
	2 1/4	57					1	1	1										
	2 1/2	64	1	1	1														
	2 5/8	65					1	1											
	2 3/4	67	1																
	3	76	1	1			1	1											
	3 1/4	83																	
	3 3/8	86																	
	3 1/2	89					1	1											
3 3/8	92	1	1																
3 3/4	95																		
4	102					1	1												
4 1/8	105	1	1																
4 1/4	108					1	1												
4 1/2	114	1	1			1	1												
4 3/4	121	1																	
Kraken Carbide Tipped Hole Saws	3/4	19	1											1					
	7/8	22	1				1												
	1 1/8	29	1				1												
	1 1/8	35	1				1												
	1 1/2	38	1																
	1 3/4	44	1				1												
	2	51	1				1												
	2 1/2	64	1				1												
MHSG Carbide Grit Hole Saws	3/4	19						1							1				
	7/8	22						1							1				
	1 1/8	29						1							1				
	1 3/8	35						1							1				
	1 1/2	38						1							1				
	1 3/4	44						1							1				
	2	51						1							1				
	2 1/4	57						1							1				
2 1/2	64						1							1					
Arbors	Chuck	Thread																	
	1/4	1/2 - 20		1			1												
	3/8	1/2 - 20	1	1	1				1						1	1	1	1	1
	3/8 Pinned	5/8 - 18	1																
	1/2 Pinned	5/8 - 18		1			1		1								1		1
	3/8 CT	1/2 - 20				1							1	1					
1/2 CT Pinned	5/8 - 18				1							1	1						
Extensions	Chuck	Length																	
	1/2	12 (305)																	
Adapters	Arbor	Saw																	
	1/2 - 20	5/8 - 18																	
Pilot Drills	Standard	2																	
	Carbide Tipped	2																	
Ejector Spring	Fits 1/4 pilot drills																		
Template																			

HOLE SAWS OPERATING PARAMETERS

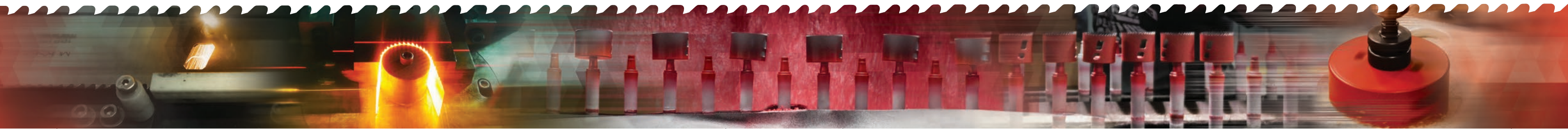

Recommended Hole Sawing Speeds (RPM)

Bi-Metal (MHS & MHSA Style)

Size in	Size mm	Mild Steel	Tool / Stainless Steels	Cast Iron	Brass	Aluminum	Size in	Size mm	Mild Steel	Tool / Stainless Steels	Cast Iron	Brass	Aluminum
9/16	14	550	300	400	790	900	2 3/8	60	140	70	95	190	220
5/8	16	530	275	365	730	825	2 1/2	64	135	70	90	180	205
1 1/16	17	500	250	330	665	750	2 9/16	65	130	65	85	175	200
3/4	19	460	230	300	600	690	2 5/8	67	130	65	85	170	195
1 3/16	21	425	210	280	560	630	2 3/4	70	125	60	80	160	185
7/8	22	390	195	260	520	585	2 7/8	73	120	60	80	160	180
1 5/16	24	370	185	245	495	555	3	76	115	55	75	150	170
1	25	350	175	235	470	525	3 1/8	79	110	55	70	145	165
1 1/16	27	325	160	215	435	480	3 1/4	83	105	50	70	140	155
1 1/8	29	300	150	200	400	450	3 3/8	86	100	50	65	130	150
1 3/16	30	285	145	190	380	425	3 1/2	89	95	45	60	125	145
1 1/4	32	275	140	180	360	410	3 5/8	92	95	45	60	120	140
1 3/16	33	260	135	175	345	390	3 3/4	95	90	45	60	120	135
1 3/8	35	250	125	165	330	375	3 7/8	98	90	45	60	115	130
1 7/16	37	240	120	160	315	360	4	102	85	40	55	115	125
1 1/2	38	230	115	150	300	345	4 1/8	105	85	40	55	110	120
1 9/16	40	220	110	145	290	330	4 1/4	108	80	40	55	110	115
1 5/8	41	210	105	140	280	315	4 3/8	111	80	40	50	100	110
1 11/16	43	205	100	135	270	305	4 1/2	114	75	35	50	100	105
1 3/4	44	195	95	130	260	295	4 3/4	121	70	35	45	90	95
1 13/16	46	190	95	125	250	285	5	127	65	30	40	85	90
1 7/8	48	180	90	120	240	270	5 1/2	140	60	30	35	80	85
2	51	170	85	115	230	255	5 3/4	146	60	30	35	80	85
2 1/16	52	165	80	110	220	245	6	152	55	25	35	75	80
2 1/8	54	160	80	105	210	240							
2 1/4	57	150	75	100	200	230							
2 5/16	59	145	75	100	195	225							

Carbide Tipped (MHSTK Style)

Size in	Size mm	Ceramic			Fiberglass	Computer Flooring	Cast Iron	Particle Board	
		Tile RPM	Plastic RPM	Formica RPM					
3/4	19	495	3425	205	1695	245	445	405	3425
7/8	22	425	2935	175	1495	205	465	345	2935
1	25	365	2565	145	1295	185	405	305	2565
1 1/8	29	325	2285	135	1095	165	365	265	2285
1 3/8	35	265	1865	105	895	135	295	215	1865
1 1/2	38	245	1705	95	895	115	265	205	1705
1 3/4	44	205	1465	85	695	105	235	175	1465
2 1/8	54	175	1285	75	595	85	205	145	1285
2 1/4	57	165	1135	65	595	75	175	135	1135
2 1/2	64	145	1025	55	495	65	155	115	1025
2 3/4	70	130	935	50	445	60	145	105	940
3	76	115	855	45	395	55	135	95	855
3 1/4	83	105	785	45	395	55	125	85	785
3 1/2	89	100	705	35	395	45	105	85	705
3 3/4	95	95	685	35	295	45	105	75	685
4	102	90	630	35	295	45	95	65	615
4 1/4	108	85	580	35	295	45	95	60	570
4 1/2	114	85	550	25	295	35	85	55	535
5	127	75	475	25	195	35	85	55	495
5 1/2	140	65	415	25	195	35	75	45	455
6	152	55	355	25	95	25	55	35	415

Carbide Grit (MHSG Style)

MATERIAL TO BE CUT	RPM	COOLANT	DUST PROTECTION
Hardened Tool Steel (Rc 42-65)	SLOW	yes	
Nitride Case & Induction Hardened Steel	SLOW	yes	
High Temp Nickel & Iron Base Superalloys	SLOW	yes	
Hastelloy	SLOW	yes	
Aircraft and Sheet Stainless	SLOW	yes	
Beryllium	SLOW	yes	
Sintered Tungsten, Molybdenum, Iron, Stainless	SLOW	optional	
White & High Allow Cast Iron	SLOW	yes	
Grey Cast Iron	SLOW	no	
Titanium	SLOW	yes	
Foamed Glass	FAST	no	yes
Syntactic Foam	MED	no	yes
Low Density Ceramics	MED	optional	yes
Green Unfired Ceramics	MED	no	yes
Fiber Reinforced Cement	MED	no	yes
Fiberglass Honeycomb	FAST	no	yes
Polyesters, Epoxies, Melamines, Phenolics	FAST	no	yes
Graphite Composites	FAST	no	yes
Carbon & Graphite	FAST	no	yes
Glass	MED	yes	
Wire Reinforced Rubber	FAST	yes	
Compressed Perlite Fiber Board	MED	no	yes
Cement Lined Steel & Cast Iron Pipe	SLOW	optional	
Soapstone, Mica, Slate, Lava, Coal	SLOW	no	yes

Slow 125-400 RPM
 Speed Ranges: Medium 400-800 RPM
 Fast 800+ RPM

Pipe Tapping:

The tapping hole should match the inner thread diameter of the male threaded fitting.

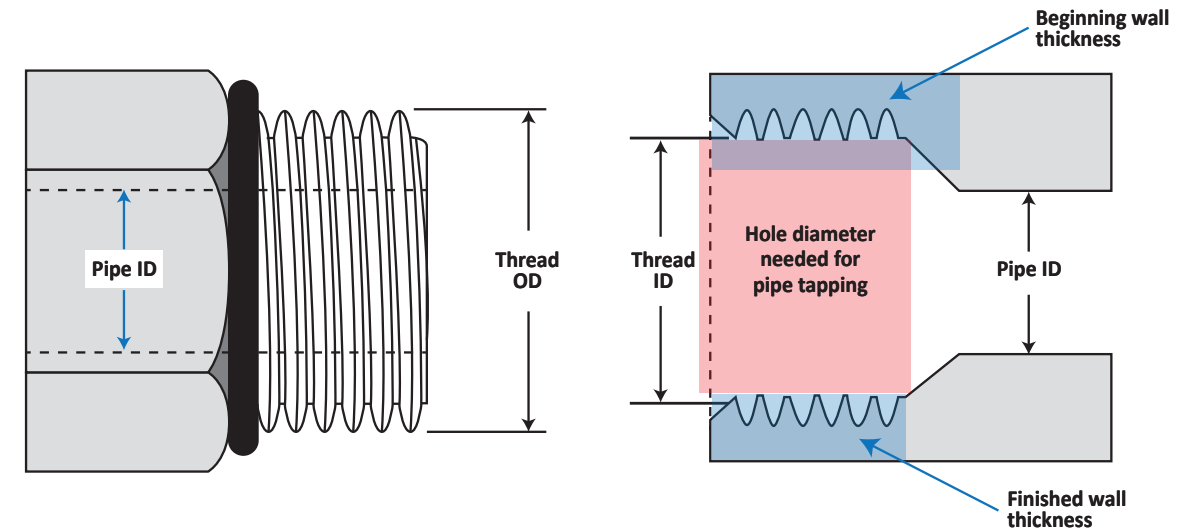

Note: Pipe diameter for 12" and smaller pipes refers to the ID (inside diameter) of the pipe. For larger pipes, diameter is the OD (outside diameter) of the pipe.

Pipe Entrance:

The hole diameter necessary so a pipe will pass through a material, with clearance.

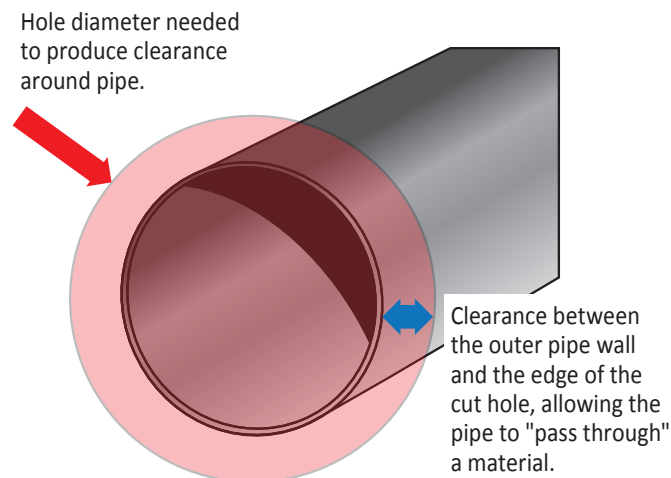

Pipe Diameter (ID)	Hole Saw Size				
	Pipe Tap		Pipe Entrance		
in	mm	in	mm	in	mm
3/8	10			3/4	19
1/2	13	3/4	19	7/8	22
3/4	19	7/8	22	1 1/8	29
1	25	1 1/8	29	1 3/8	35
1 1/4	32	1 1/2	38	1 3/4	44
1 1/2	38	1 3/4	44	2	51
2	51	2 1/4	57	2 1/2	64
2 1/2	64	2 5/8	67	3	76
3	76	3 3/4	83	3 3/8	92
3 1/2	89	3 3/4	95	4 1/8	105
4	102	4 1/2	114	4 3/8	117
4 1/2	114	4 3/4	121		

PRECISION HOLE CUTTING METAL



CARBIDE TIPPED HOLE CUTTERS

Precision cutting for high production applications. Makes clean, fast cuts in sheet metal, stainless steel, pipe, conduit, aluminum and composites.

Applications

- ▼ Sheet metal
- ▼ Stainless steel
- ▼ Pipe
- ▼ Aluminum
- ▼ PVC/ABS
- ▼ Plastic

Benefits

- ▼ Precision ground triple chip tooth for smooth cutting
- ▼ Two cutting depths offered: 1" (25mm) for pipe and conduit 3/16" (4.5mm) for sheet metal
- ▼ Ejector spring for slug removal
- ▼ Step-center pilot bit reduces "break through" impact
- ▼ Grooved gullet directs chips away from the cut
- ▼ Flat shank fits 3/8" and larger drill chucks



Items noted in **BOLD** also available in kits. See pages 63.

Diameter		Shallow Cut Depth 3/16" (4.5mm)				Deep Cut Depth 1" (25mm)			
in	mm	Shank		Model	Part	Shank		Model	Part
		in	mm	1/Tube		in	mm	1/Tube	
9/16	14	3/8	10	CTS09	166034	3/8	10	CTD09	167024
5/8	16	3/8	10	CTS10	166041	3/8	10	CTD10	167031
11/16	17	3/8	10	CTS11	166058	3/8	10	CTD11	167048
3/4	19	3/8	10	CTS12	166065	3/8	10	CTD12	167055
	20	3/8	10	CTS125	166577	3/8	10	CTD125	167437
13/16	21	3/8	10	CTS13	166072	3/8	10	CTD13	167062
7/8	22	3/8	10	CTS14	166089	3/8	10	CTD14	167079
15/16	24	3/8	10	CTS15	166096	3/8	10	CTD15	167086
	25	3/8	10	CTS155	166584	3/8 / 1/2	10 / 13	CTD155	167444
1	25	3/8	10	CTS16	166102	3/8 / 1/2	10 / 13	CTD16	167093
1 1/16	27	3/8	10	CTS17	166119	3/8 / 1/2	10 / 13	CTD17	167109
1 1/8	29	3/8	10	CTS18	166126	3/8 / 1/2	10 / 13	CTD18	167116
1 1/16	30	3/8	10	CTS19	166133	3/8 / 1/2	10 / 13	CTD19	167123
1 1/32	31	3/8	10	CTS195	166140				
1 1/4	32	3/8	10	CTS20	166157	3/8 / 1/2	10 / 13	CTD20	167130
	32	3/8	10	CTS205	166591	3/8 / 1/2	10 / 13	CTD205	167451
1 1/16	33	3/8	10	CTS21	166164	3/8 / 1/2	10 / 13	CTD21	167147
1 3/8	35	3/8	10	CTS22	166171	3/8 / 1/2	10 / 13	CTD22	167154
1 7/16	37	3/8	10	CTS23	166188	3/8 / 1/2	10 / 13	CTD23	167161
	38	3/8	10	CTS235	166607	3/8 / 1/2	10 / 13	CTD235	167468
1 1/2	38	3/8	10	CTS24	166195	3/8 / 1/2	10 / 13	CTD24	167178
1 1/16	40	3/8	10	CTS25	166201	3/8 / 1/2	10 / 13	CTD25	167185
1 5/8	41	3/8	10	CTS26	166218	1/2	13	CTD26	167192
1 11/16	43	3/8	10	CTS27	166225	1/2	13	CTD27	167208
1 3/4	44	3/8	10	CTS28	166232	1/2	13	CTD28	167215
1 13/16	46	3/8	10	CTS29	166249	1/2	13	CTD29	167222
1 7/8	48	3/8	10	CTS30	166256	1/2	13	CTD30	167239
1 15/16	49	3/8	10	CTS31	166263	1/2	13	CTD31	167246
	50	3/8	10	CTS315	166614	1/2	13	CTD315	167475
2	51	3/8	10	CTS32	166270	1/2	13	CTD32	167253
2 1/16	52	3/8	10	CTS33	166621				
2 1/8	54	3/8	10	CTS34	166287	1/2	13	CTD34	167260
2 3/16	56	3/8	10	CTS35	166294				
2 1/4	57	3/8	10	CTS36	166300	1/2	13	CTD36	167277
2 5/16	59	3/8	10	CTS37	166317				
2 3/8	60	3/8	10	CTS38	166324	1/2	13	CTD38	167284

Diameter		Shallow Cut Depth 3/16" (4.5mm)				Deep Cut Depth 1" (25mm)			
in	mm	Shank		Model	Part	Shank		Model	Part
		in	mm	1/Box		in	mm	1/Box	
27/16	62	1/2	13	CTS39	166331				
2 1/2	64	1/2	13	CTS40	166348	1/2	13	CTD40	167291
2 5/16	65	1/2	13	CTS41	166355	1/2	13	CTD41	167307
2 3/8	67	1/2	13	CTS42	166362	1/2	13	CTD42	167314
2 11/16	68	1/2	13	CTS435	166379				
2 3/4	70	1/2	13	CTS44	166386	1/2	13	CTD44	167321
2 13/16	71	1/2	13	CTS45	166393				
2 7/8	73	1/2	13	CTS46	166409	1/2	13	CTD46	167338
2 15/16	75	1/2	13	CTS47	166416				
3	76	1/2	13	CTS48	166423	1/2	13	CTD48	167345
3 1/8	79	1/2	13	CTS50	166430				
3 1/4	83	1/2	13	CTS52	166447	1/2	13	CTD52	167352
3 3/8	86	1/2	13	CTS54	166454				
3 1/2	89	1/2	13	CTS56	166461	1/2	13	CTD56	167369
3 5/8	92	1/2	13	CTS58	166478	1/2	13	CTD58	167376
3 3/4	95	1/2	13	CTS60	166485	1/2	13	CTD60	167383
3 7/8	98	1/2	13	CTS62	166492				
4	102	1/2	13	CTS64	166508	1/2	13	CTD64	167390
4 1/8	105	1/2	13	CTS66	166515	1/2	13	CTD66	167406
4 1/4	108	1/2	13	CTS68	166522	1/2	13	CTD68	167413
4 3/8	111	1/2	13	CTS70	166539				
4 1/2	114	1/2	13	CTS72	166546	1/2	13	CTD72	167420
4 3/4	121	1/2	13	CTS76	166553				
5	127	1/2	13	CTS80	166560				

Kits

Electrician			Components		Electrician			Components		Mechanical Contractor			Components	
Depth	Model	Part	Diameter		Depth	Model	Part	Diameter		Depth	Model	Part	Diameter	
			in	mm				in	mm				in	mm
Shallow	CTS02	166737	7/8	22	Shallow	CTS01	166720	7/8	22	Deep	CTD01	167543	1 1/16	17
			1 1/8	29				1 1/8	29				1 3/16	21
			1 3/8	35				1 3/8	35				1 5/16	24
			1 1/2	44									1 7/16	27
			2	51				TCT Stepped Pilot Drill					TCT Stepped Pilot Drill	
			2 1/2	64				Ejector Spring					Ejector Spring	
								Hex Key					Hex Key	

Accessories Items noted in **BOLD** also available in kits. See below.

Description	Shallow 1/Pack		Deep 1/Pack	
Set Screws	CTSW01	166003	CTSW01	166003
TCT Stepped Pilot Drill for less than 4" (102mm)	CTSP	166010	CTDP	167000
TCT Stepped Pilot Drill for 4" (102mm) and up	CTSPXL	166638	CTDPXL	167482
Ejector Springs	CTSS	166027	CTDS	167017

PRECISION HOLE CUTTING METAL



STEP DRILLS

Designed for repetitive hole cutting or enlargement for electrical, automotive and sheet metal applications.

Applications

- ▼ Steel
- ▼ Sheet Metal
- ▼ Aluminum
- ▼ Copper
- ▼ Brass
- ▼ Plexiglass
- ▼ Plasterboard
- ▼ PVC and other plastics

Benefits

- ▼ Reduce secondary operations with trailing flute that automatically deburs holes
- ▼ Increase accuracy when drilling with 3 flats on shank for secure fastening in drill
- ▼ Faster penetration than standard points with split point tip for self starting drills
- ▼ Re-sharpenable cutting edges allows for longer tool life



Items noted in **BOLD** also available in kits. See below.

Description	Shank	High Speed Steel		TiN Coated	
		Model	Part	Model	Part
Self-Starting		1/Box		1/Box	
1/8 - 1/2 by 32nds	1/4 Impact	SDSS01	124409	SDSS01TIN	124522
1/8 - 3/8 by 16ths	1/4 Impact	SDSS02	124416		
1/8 - 1/2 by 16ths	1/4 Impact	SDSS03	124423		
3/16 - 1/2 by 16ths	1/4 Impact	SDSS04	124430		
3/16 - 7/8 by 16ths	1/4 Impact	SDSS05	124447	SDSS05TIN	124539
1/4 - 3/4 by 16ths	1/4 Impact	SDSS06	124454	SDSS06TIN	124546
1/4 - 1 by 16ths	1/4 Impact	SDSS08	124478		
1/4 - 1 1/8 by 16ths	1/4 Impact	SDSS09	124485		
1/4 - 1 1/8 by 16ths	3/8	SDSS09H	124553		
1/4 - 1 3/8 by 8ths	3/8	SDSS10	124492		
Hole Enlarging - 1/2" or Larger Pilot Hole					
3/16 - 1 by 16ths	1/4 Impact	SDHE11	124508		
3/4 - 1 3/8 by 16ths	3/8	SDHE12	124515		



Kit - Electrician's/Automotive

High Speed Steel		Components	
Model	Part	Description	Shank
SDKIT01	124607	1/8 - 1/2 by 32nds	1/4 Impact
		3/16 - 7/8 by 16ths	1/4 Impact
		1/4 - 1 1/8 by 16ths	1/4 Impact



WOOD CUTTING



DOUBLE CUT AUGER BITS

Excellent for deep boring in wood and nail-embedded wood. Applications include landscaping timbers, log and timber frame construction, plumbing and electrical installations.

Benefits

- ▼ Self-feed screw point for effortless boring
- ▼ Double flute design for fast chip removal and less clearing of bit
- ▼ The ability to resharpen edge allows for quick touch ups to maintain edge and life of bit



Bore Diameter		Shank	7 1/2 in (191 mm)		18 in (457 mm)		36 in (914 mm)	
in	mm		Model	Part	Model	Part	Model	Part
			1/Box		1/Box		1/Box	
1/4	6	1/4	WSAB750250	125772				
5/16	8	5/16	WSAB750312	125789				
3/8	10	3/8	WSAB750375	125796	WSAB180375	125505		
7/16	11	7/16	WSAB750437	124973	WSAB180437	125512		
1/2	13	7/16	WSAB750500	124980	WSAB180500	125529		
9/16	14	7/16	WSAB750562	124997	WSAB180562	125536	WSAB360562	125178
5/8	16	7/16	WSAB750625	125666	WSAB180625	125543	WSAB360625	125185
11/16	17	7/16	WSAB750687	125673	WSAB180687	125550	WSAB360687	125192
3/4	19	7/16	WSAB750750	125680	WSAB180750	125567	WSAB360750	125239
13/16	21	7/16	WSAB750812	125697	WSAB180812	125574	WSAB360812	125246
7/8	22	7/16	WSAB750875	125703	WSAB180875	125581	WSAB360875	125253
15/16	24	7/16	WSAB750937	125710	WSAB180937	125598	WSAB360937	125260
1	25	7/16	WSAB751000	125727	WSAB181000	125604	WSAB361000	125277
1 1/16	27	7/16			WSAB181062	125611	WSAB361062	125284
1 1/8	29	7/16	WSAB751125	125734	WSAB181125	125628	WSAB361125	125291
1 1/4	32	7/16	WSAB751250	125741	WSAB181250	125635		
1 3/8	35	7/16	WSAB751375	125758	WSAB181375	125642		
1 1/2	38	7/16	WSAB751500	125765	WSAB181500	125659		



WOOD CUTTING



SPADE BITS

Fast, deep cutting in wood, plywood, composites and laminates.

Applications

- ▼ Wood
- ▼ Plastic
- ▼ Plywood
- ▼ Formica
- ▼ Wood composites

Benefits

- ▼ Produce a cleaner hole with less vibration with the angled spur
- ▼ Uses bit to pull lead wire back through the drilled hole
- ▼ 1/4" (6.4mm) quick change shank size fits all power drills



Bore Diameter		10/Box	
in	mm	Model	Part
1/4	6	WSB250	125000
5/16	8	WSB312	125017
3/8	10	WSB375	125024
7/16	11	WSB437	125031
1/2	13	WSB500	125048
9/16	14	WSB562	125055
5/8	16	WSB625	125062
11/16	17	WSB687	125079
3/4	19	WSB750	125086
13/16	21	WSB812	125093
7/8	22	WSB875	125109
15/16	24	WSB937	125116
1	25	WSB1000	125123
1 1/8	29	WSB1125	125130
1 1/4	32	WSB1250	125147
1 3/8	35	WSB1375	125154
1 1/2	38	WSB1500	125161





RECIPROCATING SAW BLADES

Blade Type Application

General Purpose

Carbide Tipped

CTR Best for cutting hard or abrasive materials including cast iron, stainless steel, fiberglass or nail-free wood.

Bi-Metal

Master Cobalt Hybrid Designed to cut a variety of materials ranging from wood and plastic, to ferrous and non-ferrous metals.

Metal

Bi-Metal

SParc Designed for faster cutting and longer blade life when cutting a variety of materials ranging from wood and plastic, to ferrous and non-ferrous metals.

Advanced Edge Power

Best for cutting machinable metals up to 1/4" thick where added beam strength is important.

Master Cobalt Metal

Best for cutting machinable metals up to 1/4" thick. Narrow blade options for radius cutting.

Wood

Bi-Metal

Master Cobalt Wood Specifically designed for cutting all types of wood, wood composites and nail-embedded wood. Narrow blade options for radius cutting.

Specialty

Demolition

Renovator Specifically designed for rough-in, plunge cutting and wider cuts in wood, wood composites or nail-embedded wood.

Havoc

Specifically designed for rough-in, plunge cutting and heavier feed pressure in wood, wood composites or nail-embedded wood.

Automotive

Auto Salvage

Optimized for automotive reclamation/recycling or other automotive modifications.

Pipe Boss

Specifically designed for tailpipe and muffler removal or other automotive modifications.

Safety

Fire + Rescue

Specifically designed for rapid cutting for automotive extraction.

Drywall & Plaster

Plaster

Designed for cutting drywall, plasterboard and plaster with wood or metal lath.

Pallet

Pallet Dismantler

Specifically designed for pallet recycling.

Grit

Diamond Grit

For use on extremely hard or abrasive materials including stone, porcelain/ceramics, brick/masonry, architectural stone and composites.

Carbide Grit

Designed to cut materials too thin, hard or abrasive for conventional carbide tipped or bi-metal blades.

GENERAL PURPOSE CARBIDE TIPPED



CTR CARBIDE TIPPED

The Morse CTR Recip is the best choice for thick metal cutting applications between 3/16" and 1/2". This high performance blade provides longer cutting life over traditional bi-metal blades.

Applications

- ▼ Cast Iron
- ▼ Threaded Rod
- ▼ Emt Conduit
- ▼ Stainless Steel
- ▼ Steel Plate
- ▼ Non-Ferrous Metal
- ▼ Rubber
- ▼ Steel Studs
- ▼ Rebar
- ▼ Black Iron Pipe
- ▼ Angle Iron
- ▼ Metal Alloys

Benefits

- ▼ More cost effective than bi-metal blades when cutting stainless steel, high strength alloys and other tough metals
- ▼ Precision ground carbide teeth
- ▼ Maximum cutting performance in thick metal applications
- ▼ 1 in x .050" blade body for straighter cuts and less vibration



TPI	in			mm			1/Card		15/Tube	
	Length	Width	Thickness	Length	Width	Thickness	Model	Part	Model	Part
8	4	1	.050	102	25	1.3	CTR408MC1	405201		
8	6	1	.050	152	25	1.3	CTR608MC1	405218	CTR608MC15	405782
8	9	1	.050	229	25	1.3	CTR908MC1	405225	CTR908MC15	405799
8	12	1	.050	305	25	1.3	CTR1208MC1	405232	CTR1208MC15	405805

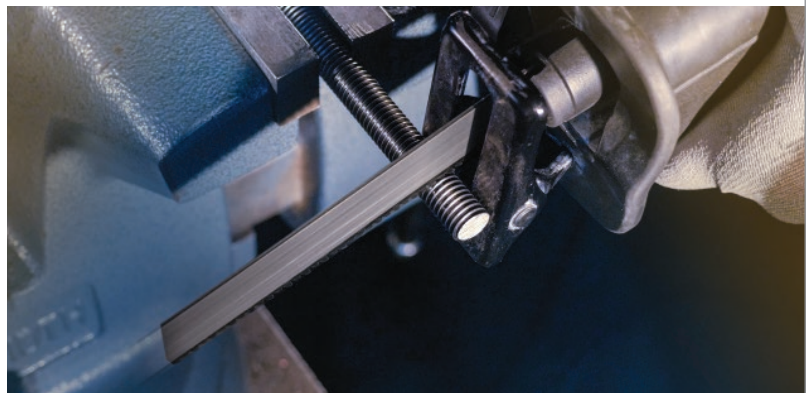

GENERAL PURPOSE BI-METAL



MORSE MASTER COBALT HYBRID WOOD METAL

MASTER COBALT® HYBRID WOOD/METAL

The Morse Master Cobalt HYBRID® reciprocating saw blade is the best choice for applications that need a blade that cuts through a variety of materials ranging from wood and plastic to ferrous and non-ferrous metals.

Features

- ▼ Available in .035" and .050" thickness
- ▼ Tapered and straight blade body options
- ▼ Straight and variable tooth pitch
- ▼ Bi-metal construction

Benefits

- ▼ .035 blades for flexibility in tight spaces
- ▼ .050 blades for rigidity and heavier feed pressure
- ▼ 1" (25mm) options for greater beam strength
- ▼ Faster cuts
- ▼ Broader range of thickness applications
- ▼ Long cutting life
- ▼ Heat and wear resistant



TPI	in			mm			5/Card		25/Tube		50/Tube	
	Length	Width	Thickness	Length	Width	Thickness	Model	Part	Model	Part	Model	Part



Items noted in **BOLD** also available in kits. See page 82.

8/12	12	3/4	.050	305	20	1.3	RB1250812T05	400916			RB1250812T50	400923
10/14	12	3/4	.035	305	20	0.9	RB121014T05	400114			RB121014T50	400107
10/14	6	3/4	.050	152	20	1.3	RB6501014TT05	398541			RB6501014TT50	398534
10/14	12	3/4	.050	305	20	1.3	RB12501014T05	402095	RB12501014T25	398640	RB12501014T50	402088



8/12	8	3/4	.050	203	20	1.3	RB850812T05	400930			RB850812T50	400947
10	6	3/4	.035	152	20	0.9	RB610T05	400398			RB610T50	400381
10	8	3/4	.035	203	20	0.9	RB810T05	400473			RB810T50	400466
10	12	3/4	.035	305	20	0.9	RB1210T05	400251			RB1210T50	400244
10/14	6	3/4	.035	152	20	0.9	RB61014T05	402002			RB61014T50	402019
10/14	8	3/4	.035	203	20	0.9	RB81014T05	402118			RB81014T50	402101
10/14	6	3/4	.050	152	20	1.3	RB6501014T05	399234			RB6501014T50	399227
10/14	8	3/4	.050	203	20	1.3	RB8501014T05	402071			RB8501014T50	402064
10/14	12	3/4	.050	305	20	1.3	RB12501014STT05	398435			RB12501014STT50	398428



10	9	1	.050	229	25	1.3	RB95010T05	404303	RB95010T25	404310		
10	12	1	.050	305	25	1.3	RB125010T05	404242	RB125010T25	404259		



METAL BI-METAL



SPARC®

SParc® RECIPROCATING SAW BLADES

The tooth angle is increased along the arc without sacrificing tooth size. This maintains the TOOTH STRENGTH while lowering cut temperatures and increasing the cutting speed.

Features

- ▼ Increased tooth angle along the arc
- ▼ Arc preserves tooth life
- ▼ SParc's arched shape creates a shifting effect on each cutting stroke

Benefits

- ▼ Faster cutting than traditional blades
- ▼ Eliminates tooth drag on the backstroke which provides a longer blade life
- ▼ Teeth stay sharper/longer



TPI	in			mm			5/Card	
	Length	Width	Thickness	Length	Width	Thickness	Model	Part
10	6	¾	.035	152	20	0.9	RBAC610T05	405409
10	9	¾	.035	229	20	0.9	RBAC910T05	405430
10	12	¾	.035	305	20	0.9	RBAC1210T05	405461
14	6	¾	.035	152	20	0.9	RBAC614T05	405416
14	9	¾	.035	229	20	0.9	RBAC914T05	405447
14	12	¾	.035	305	20	0.9	RBAC1214T05	405478
18	6	¾	.035	152	20	0.9	RBAC618T05	405423
18	9	¾	.035	229	20	0.9	RBAC918T05	405454
18	12	¾	.035	305	20	0.9	RBAC1218T05	405485





ADVANCED EDGE POWER®

The Morse Advanced Edge Power® reciprocating saw blade “powers” through the toughest applications. This heavy duty blade is perfect for cutting any machinable metal, as well as wood, wood composite, plastic, or rubber.

Features

- ▼ Available in 1" (25mm) width and .042" (1.00mm) thickness
- ▼ Straight tooth pitch
- ▼ Bi-metal construction

Benefits

- ▼ 1" (25mm) width blades provide more rigidity and beam strength
- ▼ .042" (1.00mm) thick blades accept heavier feed pressure
- ▼ Smooth cutting action
- ▼ Long cutting life
- ▼ Heat and wear resistant



Items noted in **BOLD** also available in kits. See page 82.

TPI	in			mm			5/Card		25/Tube		100/Box	
	Length	Width	Thickness	Length	Width	Thickness	Model	Part	Model	Part	Model	Part
10	6	1	.042	152	25	1.1	RBWP64210T05	392006	RBWP64210T25	392013		
10	9	1	.042	229	25	1.1	RBWP94210T05	392068	RBWP94210T25	392075		
10	12	1	.042	305	25	1.1	RBWP124210T05	392129	BWP124210T25	392136		
14	6	1	.042	152	25	1.1	RBWP64214T05	392020	RBWP64214T25	392037		
14	9	1	.042	229	25	1.1	RBWP94214T05	392082	RBWP94214T25	392099		
14	12	1	.042	305	25	1.1	RBWP124214T05	392143	BWP124214T25	392150		
18	6	1	.042	152	25	1.1	RBWP64218T05	392044	RBWP64218T25	392051	RBWP64218B100	392266
18	9	1	.042	229	25	1.1	RBWP94218T05	392105	RBWP94218T25	392112	RBWP94218B100	392273
18	12	1	.042	305	25	1.1	RBWP124218T05	392167	BWP124218T25	392174	RBWP124218B100	392280



METAL BI-METAL



MASTER COBALT® METAL

The Morse Master Cobalt Metal reciprocating blade is the best choice for cutting any machinable metal up to 1/4" (6.4mm) in thickness.

Features

- ▼ Available in .035" and .050" thickness
- ▼ Straight back blade body
- ▼ Straight and variable tooth pitch
- ▼ Reinforced tooth design with compound relief
- ▼ Bi-metal construction

Benefits

- ▼ .035 blades for flexibility in tight spaces
- ▼ .050 blades for increased rigidity and heavier feed pressure
- ▼ High impact resistance
- ▼ More aggressive cutting
- ▼ Long cutting life
- ▼ Heat and wear resistant



Items noted in **BOLD** also available in kits. See page 82.

TPI	in			mm			5/Card		25/Tube		50/Tube	
	Length	Width	Thickness	Length	Width	Thickness	Model	Part	Model	Part	Model	Part
14	4	3/4	.035	102	20	0.9	RB414T05	400237			RB414T50	400220
14	6	3/4	.035	152	20	0.9	RB614T05	400411	RB614T25	398671	RB614T50	400404
14	8	3/4	.035	203	20	0.9	RB814T05	400497	RB814T25	398763	RB814T50	400480
14	9	3/4	.035	229	20	0.9	RB914T05	400985			RB914T50	400992
14	12	3/4	.035	305	20	0.9	RB1214T05	400138			RB1214T50	400121
14	6	3/4	.050	152	20	1.3	RB65014T05	399623			RB65014T50	399616
18	4	3/4	.035	102	20	0.9	RB418T05	400275			RB418T50	400268
18	6	3/4	.035	152	20	0.9	RB618T05	400435	RB618T25	398688	RB618T50	400428
18	8	3/4	.035	203	20	0.9	RB818T05	402590	RB818T25	398770	RB818T50	402583
18	9	3/4	.035	229	20	0.9	RB918T05	401005			RB918T50	401012
18	10	3/4	.035	254	20	0.9	RB1018T05	398497			RB1018T50	398480
18	12	3/4	.035	305	20	0.9	RB1218T05	400213	RB1218T25	398619	RB1218T50	400206
18	6	3/4	.050	152	20	1.3	RB65018T05	399647			RB65018T50	399630
24	4	3/4	.035	102	20	0.9	RB424T05	400312			RB424T50	400305
24	6	3/4	.035	152	20	0.9	RB624T05	400459	RB624T25	398701	RB624T50	400442



14	9	1	.050	229	25	1.3	RB95014T05	404327	RB95014T25	404334		
14	12	1	.050	305	25	1.3	RB125014T05	404266	RB125014T50	404273		
18	9	1	.050	229	25	1.3	RB95018T05	404341	RB95018T25	404358		
18	12	1	.050	305	25	1.3	RB125018T05	404280	RB125018T25	404297		

WOOD BI-METAL



MASTER COBALT® WOOD

The Morse Master Cobalt Wood reciprocating blade is specifically designed for cutting all types of wood, wood composites, and nail embedded wood.

FEATURES

- ▼ Available in .035" and .050" thickness
- ▼ Tapered blade body
- ▼ Straight and variable tooth pitch
- ▼ Reinforced tooth design with compound relief
- ▼ Positive rake on 6 TPI blades
- ▼ Bi-metal construction

BENEFITS

- ▼ .035 blades for flexibility in tight spaces
- ▼ .050 blades for increased rigidity
- ▼ Best for plunge cutting
- ▼ Easier feed in wood
- ▼ High impact resistance
- ▼ More aggressive cutting
- ▼ Long cutting life
- ▼ Heat and wear resistant



Items noted in **BOLD** also available in kits. See page 82.

TPI	in			mm			5/Card		25/Tube		50/Tube	
	Length	Width	Thickness	Length	Width	Thickness	Model	Part	Model	Part	Model	Part
6	6	7/16	.050	152	12	1.3	RB65006CT05	399517			RB65006CT50	399500
5/8	6	3/4	.050	152	20	1.3	RB65058T05	398510			RB65058T50	398503
5/8	12	3/4	.050	305	20	1.3					RB125058T50	398442
6	6	3/4	.035	152	20	0.9	RB63506T05	400190			RB63506T50	400183
6	9	3/4	.035	229	20	0.9	RB93506T05	400176			RB93506T50	400169
6	12	3/4	.035	305	20	0.9	RB123506T05	400152			RB123506T50	400145
6	6	3/4	.050	152	20	1.3	RB65006T05	402040	RB65006T25	398732	RB65006T50	402057
6	9	3/4	.050	229	20	1.3	RB95006T05	402026	RB95006T25	398794	RB95006T50	402033
6	12	3/4	.050	305	20	1.3	RB125006T05	402156	RB125006T25	398633	RB125006T50	402149



SPECIALTY DEMOLITION



RENOVATOR®

RENOVATOR®

The Morse RENOVATOR® reciprocating saw blade is the ultimate heavy duty, demolition/remodeling blade in the market. This blade cuts through wood and metals without leaving frayed or jagged cut edges, no need for additional finishing.

Features

- ▼ Available in .062" (1.60mm) thickness
- ▼ Available in 1" (25mm) blade width
- ▼ Tapered blade body
- ▼ Variable tooth pitch
- ▼ Reinforced tooth design
- ▼ Bi-metal construction

Benefits

- ▼ Provides increased rigidity for more stable cutting in wider cuts
- ▼ 1" (25mm) wide blades offer more beam strength
- ▼ Best for plunge cutting
- ▼ Fast cutting
- ▼ Smooth cut finish
- ▼ High impact resistant tooth
- ▼ Long cutting life
- ▼ Heat and wear resistant

Items noted in **BOLD** also available in kits. See page 82.



TPI	in			mm			3/Card		20/Tube	
	Length	Width	Thickness	Length	Width	Thickness	Model	Part	Model	Part
8/11	6	1	.062	152	25	1.6	RBR662811T03	392518	RBR662811T20	392525
8/11	9	1	.062	229	25	1.6	RBR962811T03	392532	RBR962811T20	392549
8/11	12	1	.062	305	25	1.6	RBR1262811T03	392556	RBR1262811T20	392563





HAVOC®

The Morse HAVOC® Demolition reciprocating saw blade is specifically designed for “roughing in” applications on the construction site. This blade will cut through all types of wood, wood composites, metal, and nail embedded wood.

Features

- ▼ Available in .062" (1.60mm) thickness
- ▼ Available in 7/8" (22mm) blade width
- ▼ Tapered blade body
- ▼ Straight tooth pitch
- ▼ Reinforced, positive rake 6 TPI tooth design
- ▼ Bi-metal construction

Benefits

- ▼ Provides minimum deflection for more stable cutting in wider cuts
- ▼ 7/8" (22mm) wide blades for increased rigidity and heavier feed pressure
- ▼ Best for plunge cutting
- ▼ Fast cutting
- ▼ High impact resistance
- ▼ More aggressive cutting
- ▼ Long cutting life
- ▼ Heat and wear resistant



Items noted in **BOLD** also available in kits. See page 82.

TPI	in			mm			3/Card		20/Tube	
	Length	Width	Thickness	Length	Width	Thickness	Model	Part	Model	Part
6	6	7/8	.062	152	22	1.6	RB66206T03	398350	RB66206T20	398343
6	9	7/8	.062	229	22	1.6	RB96206T03	402422	RB96206T20	402415
6	12	7/8	.062	305	22	1.6	RB126206T03	398312	RB126206T20	398305
10	6	7/8	.062	152	22	1.6	RB66210T03	398374	RB66210T20	398367
10	9	7/8	.062	229	22	1.6	RB96210T03	402446	RB96210T20	402439
10	12	7/8	.062	305	22	1.6	RB126210T03	398336	RB126210T20	398329



SPECIALTY AUTOMOTIVE



AUTO SALVAGE®

AUTO SALVAGE

The Morse Auto SALVAGE® reciprocating blade is targeted for any automotive reclamation/recycling, but can also be used for other automotive modifications requiring metal cutting.

Features

- ▼ Available in .035" (0.90mm) thickness
- ▼ Available in ¾" (20mm) blade width
- ▼ Straight and variable tooth pitch
- ▼ Bi-metal construction

Benefits

- ▼ .035" (0.90mm) thick blades for flexibility in tight spaces
- ▼ Cut between body panels, gets under stripped/rusted fasteners
- ▼ ¾" (20mm) wide blades provide flexibility
- ▼ Allows for cutting in hard to reach places that a cutting torch would otherwise create more damage
- ▼ Smooth cutting action
- ▼ High impact resistant tooth
- ▼ Long cutting life
- ▼ Heat and wear resistant



TPI	in			mm			5/Card		50/Tube	
	Length	Width	Thickness	Length	Width	Thickness	Model	Part	Model	Part
14	8	¾	.035	203	20	0.9	RBSA814T05	395557	RBSA814T50	395564
18	6	¾	.035	152	20	0.9	RBSA618T05	395533	RBSA618T50	395540
18	8	¾	.035	203	20	0.9	RBSA818T05	395571	RBSA818T50	395588





PIPE BOSS

PIPE BOSS®

The Morse PIPE BOSS reciprocating saw blade is specifically targeted for tailpipe and muffler removal, but can also be used for other automotive modifications where metal cutting is necessary.

Features

- ▼ Available in .050" (1.30mm) thickness
- ▼ Available in 1" (25mm) blade width
- ▼ Straight tooth pitch
- ▼ Bi-metal construction

Benefits

- ▼ .050" (1.30mm) thick blades accept heavier feed pressure
- ▼ 1" (25mm) wide blades provide more rigidity and beam strength
- ▼ Smooth cutting action
- ▼ Heat and wear resistant
- ▼ Long cutting life



TPI	in			mm			25/Tube	
	Length	Width	Thickness	Length	Width	Thickness	Model	Part
14	6	1	.050	152	25	1.3	RBPB65014T25	395021
14	9	1	.050	229	25	1.3	RBPB95014T25	395045
14	12	1	.050	305	25	1.3	RBPB125014T25	395069



SPECIALTY SAFETY



FIRE + RESCUE

The Morse FIRE + RESCUE reciprocating saw blade is preferred by professional firefighters who rely on quality and consistency. This blade is specifically designed for automotive extrication.

Features

- ▼ Available in .062" thickness
- ▼ Available in 7/8" blade width
- ▼ Straight tooth pitch
- ▼ Optimized set pattern
- ▼ Bi-metal construction

Benefits

- ▼ Provides minimum deflection for more stable cutting in wider cuts
- ▼ 7/8" wide blades for increased rigidity and heavier feed pressures
- ▼ Quick and more efficient cutting in multiple wall applications
- ▼ Reduces vibration and operator fatigue
- ▼ Reduces chance for blade binding in cut
- ▼ Long cutting life
- ▼ Heat and wear resistant



Items noted in **BOLD** also available in kits. See page 82 .

TPI	in			mm			3/Card		20/Tube	
	Length	Width	Thickness	Length	Width	Thickness	Model	Part	Model	Part
10	6	7/8	.062	152	22	1.6	RBFR66210WT03	403665	RBFR66210WT20	403511
10	9	7/8	.062	229	22	1.6	RBFR96210WT03	403689	RBFR96210WT20	403528
10	12	7/8	.062	305	22	1.6	RBFR126210WT03	403702	RBFR126210WT20	403504
14	6	7/8	.062	152	22	1.6	RBFR66214WT03	403672	RBFR66214WT20	403542
14	9	7/8	.062	229	22	1.6	RBFR96214WT03	403696	RBFR96214WT20	403559
14	12	7/8	.062	305	22	1.6	RBFR126214WT03	403719	RBFR126214WT20	403535



SPECIALTY DRYWALL & PLASTER



MORSE PLASTER

PLASTER / LATH & DRYWALL CUTTING

PLASTER

The Morse PLASTER reciprocating saw blade is specifically designed for cutting drywall, plasterboard, and plaster with wood or metal lath. With a "V" style tooth, cut edge fraying/chipping is significantly reduced, requiring less finishing.

FEATURES

- ▼ Available in .050" thickness
- ▼ Blade width of 3/4"
- ▼ Special "V" tooth design
- ▼ Bi-metal construction

BENEFITS

- ▼ .050" blades for increased rigidity and heavier feed pressures
- ▼ 3/4" wide blades provide flexibility
- ▼ Cuts in both directions
- ▼ Long cutting life
- ▼ Heat and wear resistant



TPI	in			mm			5/Card		50/Tube	
	Length	Width	Thickness	Length	Width	Thickness	Model	Part	Model	Part
6	6	3/4	.050	152	20	1.3	RB606PT05	400350	RB606PT50	400343



SPECIALTY PALLET



PALLET DISMANTLER

PALLET DISMANTLER

The Morse PALLET DISMANTLER reciprocating saw blade is specifically designed for pallet recycling.

Features

- ▼ Available in ¾" width by .035" thickness
- ▼ Round nose design
- ▼ Straight tooth pitch
- ▼ Narrow kerf

Benefits

- ▼ .035" (0.90mm) blades for greater flexibility to get between boards
- ▼ Helps prevent blade from catching between boards
- ▼ Smooth cutting action
- ▼ Fast cutting
- ▼ Less damage to boards that can be re-used



TPI	in			mm			250/Box		500/Box	
	Length	Width	Thickness	Length	Width	Thickness	Model	Part	Model	Part
10	8	¾	.035	203	20	0.9			RB810RRPB500	401425
10	9	¾	.035	229	20	0.9	RB910RRPB250	401661		
10	10	¾	.035	254	20	0.9	RB1010RRB250	401463		



SPECIALTY GRIT



DIAMOND GRIT™

DIAMOND GRIT®

The Morse DIAMOND GRIT reciprocating saw blade is specifically designed for the commercial or residential cutting of ceramics, granites, and stone.

Features

- ▼ Available in 3/4" width
- ▼ Tempered steel blade body
- ▼ Industrial diamond grit edge
- ▼ Narrow kerf

Benefits

- ▼ Blades provide flexibility
- ▼ Durable, straighter cuts
- ▼ Smooth cutting action
- ▼ Longer life than carbide grit
- ▼ Fast cutting



TPI	in			mm			1/Card	
	Length	Width	Thickness	Length	Width	Thickness	Model	Part
Coarse	6	3/4		152	20		RBDG6C	129701
Coarse	9	3/4		229	20		RBDG9C	129718



CARBIDE GRIT

CARBIDE GRIT

The Morse CARBIDE GRIT reciprocating saw blade is the best design for cutting materials too thin, hard, or abrasive for conventional carbide tipped or bi-metal blades. Applications such as hardened steel, formed glass, fiberglass, laminates and composites.

Features

- ▼ Available in 3/4" (20mm) width
- ▼ Tempered steel body
- ▼ Carbide grit edge
- ▼ Narrow kerf

Benefits

- ▼ 3/4" wide blades for greater flexibility
- ▼ Durable, straighter cuts
- ▼ Won't tear thin materials
- ▼ Resistant to heat
- ▼ Fast cutting



TPI	in			mm			1/Card		3/Card		25/Tube	
	Length	Width	Thickness	Length	Width	Thickness	Model	Part	Model	Part	Model	Part
Coarse	4	3/4		102	20		RCTCG4	402750	RTCG4T03	403368	RTCG4T25	402910
Coarse	6	3/4		152	20		RCTCG6	402767	RTCG6T03	403375	RTCG6T25	402927
Coarse	8	3/4		203	20		RCTCG8	402774	RTCG8T03	403382	RTCG8T25	402934



RECIP KITS

RECIP KITS & ASSORTMENTS

Multi-pack assortments of popular blade types and sizes for a variety of applications. Kits come with plastic storage boxes or tubes.



								General Purpose	Heavy Duty	Demolition	Contractor General Use	Contractor Heavy Duty	Assortment Card	
Component	TPI	in			mm			RBKITGP01	RBKITHD01	RBKITDM01	RBKIT03	RBKIT01	RBKIT02	RBP01
		length	width	Thickness	length	width	Thickness	397483	397490	397971	405027	405003	405010	403030
Master Cobalt Hybrid®	10	6	¾	.035	152	20	0.9					7		
	10/14	6	¾	.035	152	20	0.9					7		
	10/14	6	¾	.050	152	20	1.3				5		5	
	10/14	8	¾	.050	203	20	1.3	2						
Advanced Edge Power®	14	9	1	.042	229	25	1.1		2					
	18	6	1	.042	152	25	1.1		4					
Master Cobalt® Metal	14	4	¾	.035	102	20	0.9							1
	14	6	¾	.035	152	20	0.9				7			1
	14	6	¾	.050	152	20	1.3					5		
	14	8	¾	.035	203	20	0.9	2						
	18	4	¾	.035	102	20	0.9							1
	18	6	¾	.035	152	20	0.9	5				7		1
	18	6	¾	.050	152	20	1.3						5	
Master Cobalt® Wood	5/8	6	¾	.050	152	20	1.3				5		5	
	6	6	¾	.035	152	20	0.9				14			
	6	6	¾	.050	152	20	1.3	6			5		10	1
	6	9	¾	.050	229	20	1.3	2						
Renovator®	8/11	6	1	.062	152	25	1.6			3				
	8/11	9	1	.062	229	25	1.6			2				
Havoc®	6	6	⅞	.062	152	22	1.6			2	4			
	6	9	⅞	.062	229	22	1.6			2				
	10	6	⅞	.062	152	22	1.6		2	2	8			
	10	9	⅞	.062	229	22	1.6		2					
Fire + Rescue	14	6	⅞	.062	152	22	1.6		2					
Storage Tube								1	1	1				



MORSE AIR SAW BLADES

Blade Type

Metal

Bi-Metal

Application

Designed for fast efficient pneumatic cutting of thin metal including radius cutting. Primarily used in auto body, trailer modification and sheet metal fabrication.

METAL BI-METAL



AIR SAW

AIR SAW RECIPROCATING SAW BLADES

The Morse AIR SAW reciprocating saw blade is specifically designed for use in pneumatic saws for thin sheet metal applications. Primarily used for automotive body modification and sheet metal fabrication.

Features

- ▼ Available in .025" and .035" thickness
- ▼ Blade widths of ½"
- ▼ Straight tooth pitch
- ▼ Bi-metal construction

Benefits

- ▼ Cut between body panels and under stripped/rusted fasteners
- ▼ ½" wide blades provide flexibility for radius cuts
- ▼ Smooth cutting action
- ▼ Long cutting life
- ▼ Heat and wear resistant



TPI	in			mm			5/Card		25/Tube	
	Length	Width	Thickness	Length	Width	Thickness	Model	Part	Model	Part
10	4	½	.025	102	13	0.64			RBA410T25	396967
14	3	½	.025	76	13	0.64	RBA314T05	398220	RBA314T25	398572
14	4	½	.025	102	13	0.64	RBA414T05	397506	RBA414T25	397513
14	4	½	.035	102	13	0.9	RBA43514T05	396844	RBA43514T25	396929
18	3	½	.025	76	13	0.64	RBA318T05	398244	RBA318T25	398589
18	4	½	.025	102	13	0.64	RBA418T05	397520	RBA418T25	397537
18	4	½	.035	102	13	0.9	RBA43518T05	396851	RBA43518T25	396936
24	3	½	.025	76	13	0.64	RBA324T05	398268	RBA324T25	398596
24	4	½	.025	102	13	0.64	RBA424T05	397544	RBA424T25	397551
24	4	½	.035	102	13	0.9	RBA43524T05	396868	RBA43524T25	396943
32	3	½	.025	76	13	0.64	RBA332T05	398282	RBA332T25	398602
32	4	½	.025	102	13	0.64	RBA432T05	397568	RBA432T25	397575





METAL DEVIL METAL CUTTING **CIRCULAR SAWS AND BLADES**

Blade Type	Application
Metal	
Steel	Designed to cut steel, angle iron, steel plate, channel iron, I-Beams, pipe, thin steel, and steel studs
Stainless steel	Ideal for cutting stainless steel plate, tubing, Unistrut, and thin steel
Aluminum/ Non-Ferrous	Engineered to cut aluminum, thin aluminum, copper, lead, and zinc
Saws & Accessories	
Circular Saws	Specifically designed for low-RPM metal cutting applications including 0-45° beveled cuts.
Chop Saw	Specifically designed for low-RPM metal cutting applications including 0-45° miter cuts.
Accessories	V-blocks improve efficiency and blade life when cutting round or square materials on the Morse chop saw.

METAL CARBIDE/CERMET

METALDEVIL



METAL DEVIL METAL-CUTTING CIRCULAR SAW BLADES

Cut through steel, stainless steel, aluminum, and other tough materials faster than ever with unrivaled blade life, cutting speed, and surface finish. Premium grade materials and tooth geometries are optimized for peak performance in specific applications.

Applications

- ▼ Steel, angle iron, steel plate, channel iron, I-beams, pipe
- ▼ Thin Steel
- ▼ Steel studs
- ▼ Stainless steel plate, tubing, Unistrut
- ▼ Aluminum, thin aluminum, aluminum extrusions
- ▼ Copper, lead, zinc

Features

- ▼ **Longer** - Premium grade materials improve durability and maximize blade life
- ▼ **Faster** - A thin kerf blade creates less heat for a faster cut
- ▼ **Smoother** - Optimized tooth geometry reduces vibration for improved surface finish and virtually no rework

Blade Diameter		Arbor	Applications	Teeth	Max RPM	Model	Part	Machines
in	mm							
5 3/8"	137	3/8"	Steel	32	4,200	CSM5383258FSC	102506	DeWalt DCS512B Makita XSC01Z; XSC01T; XSC03Z Bosch CSM180B; CSM180-01 Milwaukee 2782-20; 2782-22
		10mm / 20mm / 3/8"	Steel	32	4,200	CSM53832FSC	102513	DeWalt DCS512B Makita XSC01Z; XSC01T; XSC03Z Bosch CSM180B; CSM180-01 Milwaukee 2782-20; 2782-22 Makita BC550; BSS301 Panasonic EY3530NQMKW
		10mm / 20mm / 3/8"	Aluminum and Non Ferrous	40	4,200	CSM53840FNFC	102520	
		10mm / 20mm / 3/8"	Stainless Steel	40	4,200	CSM53840FSSC	102902	
5 7/8"	150	20mm	Steel	34	4,200	CSM5883420FSC	102537	Milwaukee 2782-20
		20mm	Aluminum and Non Ferrous	40	4,200	CSM5884020FNFC	102551	
		3/8"	Steel	34	4,200	CSM5883458FSC	102544	Makita XSC02Z; XSC04Z
		3/8"	Aluminum and Non Ferrous	40	4,200	CSM5884058FNFC	102568	
6 1/2"	165	20mm	Steel	40	4,200	CSM6504020FSC	102575	Panasonic EY3552GQW Hilti SCM22-A; SCW22-A; 03490197; SC 5ML-22
		3/8"	Steel	40	4,200	CSM6504058FSC	102582	Bosch CCS180B Makita BSS610 DeWalt DCS391, DCS565 Rigid R3203 Hilti SCM22-A Porter Cable PCC660B Metabo MKS18LTX; KS18LTX Milwaukee 2730-20
		20mm / 3/8"	Aluminum and Non Ferrous	48	4,200	CSM6504820FNFC	102612	Bosch CCS180B Makita BSS610 DeWalt DCS391, DCS565 Rigid R3203 Hilti SCM22-A Porter Cable PCC660B Metabo MKS18LTX; KS18LTX Panasonic EY3552GQW Hilti SCM22-A; SCW22-A; 03490197; SC 5ML-22 Milwaukee 2730-20
		20mm / 3/8"	Stainless Steel	48	4,200	CSM6504820FSSC	102599	
7 1/4"	184	3/8" K.O.	Steel	48	5,800	CSM7254858FSC	102636	Standard 7-1/4" - 5/8" arbor circular saws
		3/8" K.O.	Aluminum and Non Ferrous	56	5,800	CSM7255658FNFC	102650	
		20mm	Steel	48	5,800	CSM7254820FSC	102643	Morse CSM7MB; CSM7NXTB Evolution EVOSAW185HD, EVOSAW180HD; S85CCSL Steelmax SM-S7 XP Fein/Sluggler 6990812000 Alfra RS185
		20mm	Aluminum and Non Ferrous	56	5,800	CSM7255620FNFC	102667	
		20mm	Stainless Steel	56	5,800	CSM7255620FSSC	102698	

- ▼ 3/8" K.O. fits both diamond and circular arbors.
- ▼ Certain 5 3/8", 5 7/8" and 6 1/2" blades contain special bushings.

Blade Diameter		Arbor	Applications	Teeth	Max RPM	Model	Part	Machines
in	mm							
8"	203	3/8" K.O.	Steel	48	5,800	CSM848FSC	102704	Milwaukee 6370-20; 6370-21; 2982-20/21 Skilsaw SPT78MMC-01; SPT78MMC-22
		3/8" K.O.	Aluminum and Non Ferrous	56	5,800	CSM856FNFC	102728	
		3/8" K.O.	Stainless Steel	56	5,800	CSM856FSSC	102711	
9"	229	1"	Steel	48	3,200	CSM948FSC	102735	Morse CSM9MB; CSM9NXTB Evolution Steel Saw 5; EVOSAW230 Jancy MCSL09; MCSL00-2 Fein/Sluggler 69908120001; MSCL09 Steelmax SM-S9 Alfra RS230 Jepsen 8230N
		1"	Aluminum and Non Ferrous	64	3,200	CSM964FNFC	102759	
		1"	Stainless Steel	64	3,200	CSM964FSSC	102742	
10"	254	3/8"	Thin Steel	52	5,200	CSM1052FTSC	102766	Bosch CM10GD Dewalt DW713 Rigid MS1065LZA RPM compatible table saws and miter saws
		3/8"	Aluminum and Non Ferrous	72	5,200	CSM1072FNFC	102773	
		3/8"	Thin Aluminum	92	5,200	CSM1092FTNFC	102780	
12"	305	1"	Steel	60	1,800	CSM1260FSC	102797	Makita LC1230 Milwaukee 6955-20 Skilsaw SPT62MTC-22 RPM compatible miter saws
		1"	Aluminum and Non Ferrous	80	3,800	CSM1280FNFC	102803	
		1"	Thin Aluminum	100	3,800	CSM12100FTNFC	102810	
		1"	Stainless Steel and Thin Steel	90	2,000	CSM1290FSSC	102834	
14"	356	1"	Steel	66	1,800	CSM1466FSC	102841	Morse CSM14MB Dewalt DW872 Evolution Fury2; Rage2; Steel Saw 2; EVOSAW380 Jancy MCCS14; MCCS14-2 Milwaukee 6190-20 Ridge 614 Fein MCCS14 Unitec 9435 Steelmax SM-S-14 Alfra RD355A Jepsen 9435 Hitachi CD14F
		1"	Aluminum and Non Ferrous	80	3,800	CSM1480FNFC	102865	
		1"	Thin Aluminum	100	3,800	CSM14100FTNFC	102872	
		1"	Stainless Steel and Thin Steel	90	1,800	CSM1490FSSC	102889	

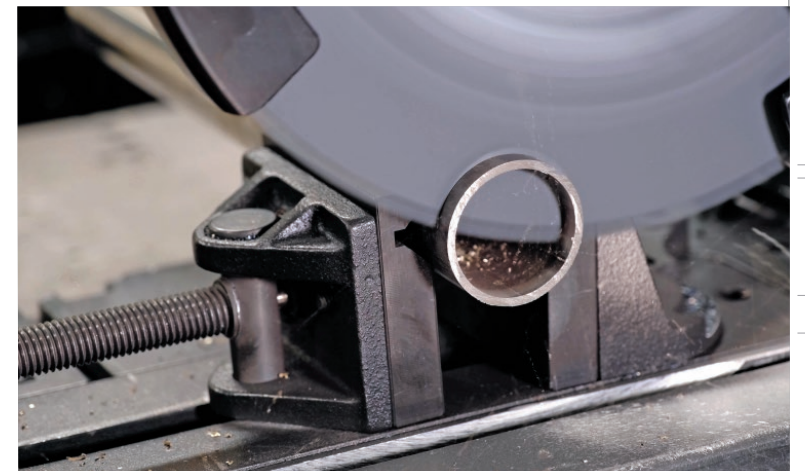

CIRCULAR SAW MACHINES



METAL DEVIL NXT® CIRCULAR SAWS

M. K. Morse stocks factory original circular saw machine parts and offers machine repairs at our facility in Canton, Ohio.



7" - 7¼" CSM7NXTB

PART 100960

INCLUDES

Laser Guide, 0-45° Beveling, Overload Switch, Cutting Guide, Ergonomically Designed Side Handle, Retracting Blade Guard, Quick Release Metal Chip Collection Chamber and Easy Blade Changes, 7' Power Cord, Carrying Case, Safety Goggles, Ear Plugs, Metal Devil teal Cutting Blade.

CUTTING CAPABILITIES

2¾" Maximum Cutting Reach
¼" Maximum Thickness of Cut Mild Steel
0-45° Bevel Cut

SPECIFICATIONS

3800 RPM | 1560 Watts
120 V | 60Hz | 13 Amp
20mm Arbor
Weight: 18 lbs



9" CSM9NXTB

PART 100977

INCLUDES

Laser Guide, 0-45° Beveling, Overload Switch, Cutting Guide, Ergonomically Designed Side Handle, Retracting Blade Guard, Quick Release Metal Chip Collection Chamber and Easy Blade Changes, 7' Power Cord, Carrying Case, Safety Goggles, Ear Plugs, Metal Devil Steel Cutting Blade.

CUTTING CAPABILITIES

3¼" Maximum Cutting Reach
¾" Maximum Thickness of Cut Mild Steel
0-45° Bevel Cut

SPECIFICATIONS

2300 RPM | 1800 Watts
120 V | 60Hz | 15 Amp
1" Arbor
Weight: 22 lbs



14" CSM14MB

PART 101172

INCLUDES

0-45° Mitering Vice, Overload Switch, Retracting Blade Guard, Quick Release Metal Chip Collection Chamber, 6mm and 8mm, Blade Wrench, Safety Goggles, Ear Plugs, Metal Devil Steel Cutting Blade.

CUTTING CAPABILITIES

	45°	90°
ROUND	4½"	5½"
SQUARE	3½" X 3½"	4¾" X 4¾"
RECTANGLE	3⅞" X 4¾"	3¾" X 7¼"

SPECIFICATIONS

1300 RPM
120 V | 60Hz | 15 Amp
1" Arbor
Weight: 53 lbs



CIRCULAR SAW ACCESSORIES

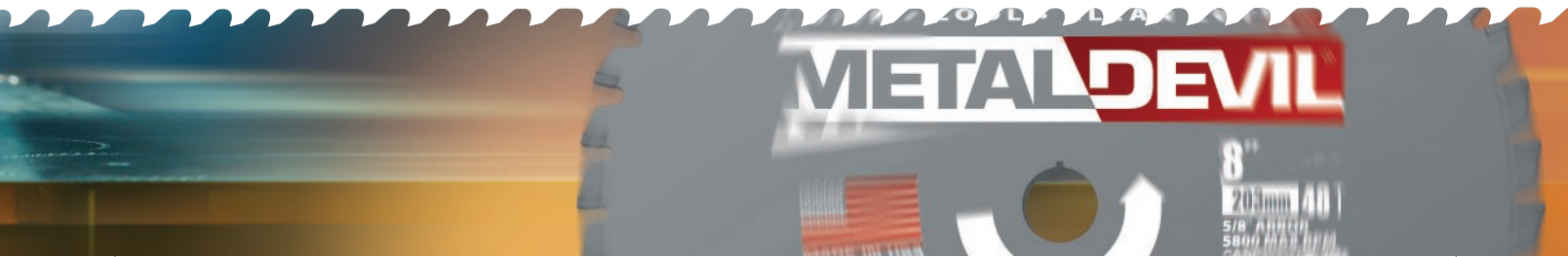

METAL DEVIL V-BLOCKS

CSP14A01 / 100724

Maximum Material Dimensions to be used with V-Blocks:

▼ Square 3 7/8"

▼ Round 3"

BENEFITS

- ▼ Durable Steel Body
- ▼ Securely Holds Rounds, Squares and Rectangular Materials
- ▼ Can Employ Several Vice Configurations to Accommodate a Variety of Structural Materials
- ▼ Strengthen The Clamping Performance of the Vice System
- ▼ Improves Cutting Performance on Structural Shapes
- ▼ Optimizes Blade Life
- ▼ Provides Precise Cutting Results
- ▼ Reduces Opportunity for Machine Damage

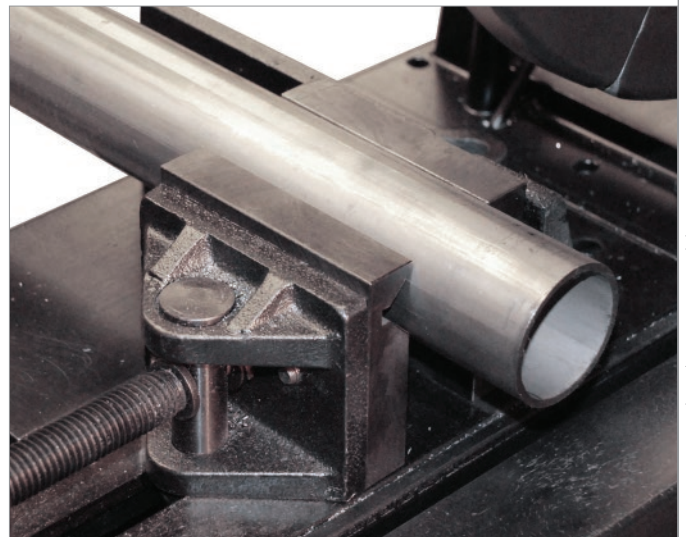
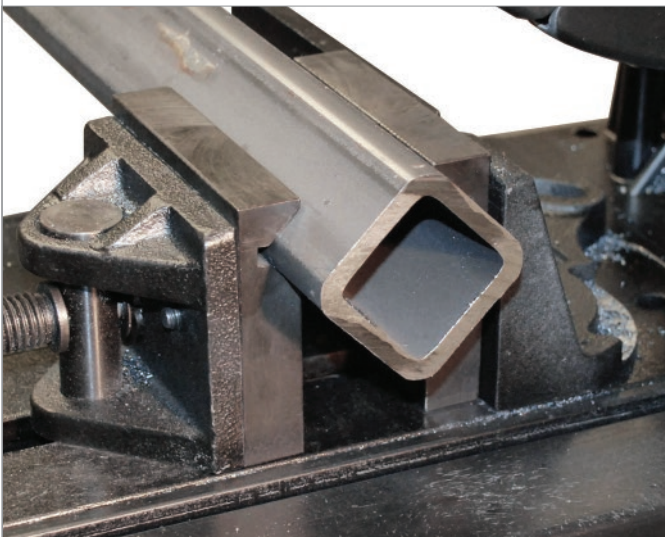



MORSE PORTABLE BAND SAW BLADES

Blade Type	Application
Metal	
811	General purpose blade designed for fastest cutting and longest life when cutting materials $\frac{1}{4}$ " and thicker. Upgraded performance in applications where 10/14 blades are used.
1216	General purpose blade designed for fastest cutting and longest life when cutting materials $\frac{3}{16}$ " and thinner. Upgraded performance in applications where 18 tooth blades are used.
Master Cobalt	For reduced vibration cutting on machinable metals including stainless steel, pipe, tubing and solids.
Straight Pitch	For use on machinable metals including stainless steel, pipe, tubing and solids.

METAL BI-METAL



811 & 1216

These high performance bi-metal portable band saw blades are the only two blades you'll need for the range of materials cut with this tool. Featuring patented tooth set technology, they cut up to 2X faster and last up to 2X longer than conventional portable band saw blades. The Morse 811 outperforms 10/14 blades for cutting materials 1/4" and thicker. The Morse 1216 outperforms 18 tooth blades when cutting materials 3/16" and thinner.

For longest blade life, the maximum recommended blade speed is 285 FPM.

Applications

- ▼ Electrical Conduit
- ▼ Strut
- ▼ Threaded Rod
- ▼ Stainless steel
- ▼ Pipe
- ▼ Tubing
- ▼ Solids
- ▼ Structural Pipes
- ▼ Machinable Metals
- ▼ PVC
- ▼ Cast Iron

Benefits

- ▼ Experience best in category performance from patent pending tooth designs
- ▼ Cut more in less time with up to 2X faster cut speed
- ▼ Spend more time cutting and less time changing blades with up to 2X longer blade life
- ▼ Cut longer with less fatigue with reduced vibration cutting
- ▼ Leaves a clean finish for welding
- ▼ Saw a wide range of materials with variable pitch blade
- ▼ Cut machinable metals with shock resistant bi-metal teeth



Length x Width x Thickness			3/Box		25/Box		Bulk 100/Box	
in	mm	TPI	Model	Part	Model	Part	Model	Part
811 - Cut Materials 1/4" and Thicker								
27 ³ / ₁₆ X 1/2 X .020	691 X 13 X .50	8/11	ZWEP27811MC	002653	ZWEP27811MCB25	005203	ZWEP27811MCB	005241
28 ¹³ / ₁₆ X 1/2 X .020	732 X 13 X .50	8/11	ZWEP28811MC	002660	ZWEP28811MCB25	005210	ZWEP28811MCB	005258
30 ³ / ₁₆ X 1/2 X .020	776 X 13 X .50	8/11	ZWEP30811MC	005623	ZWEP30811MCB25	005654	ZWEP30811MCB	005685
32 ⁷ / ₁₆ X 1/2 X .020	835 X 13 X .50	8/11	ZWEP32811MC	002677	ZWEP32811MCB25	005227	ZWEP32811MCB	005265
35 ³ / ₁₆ X 1/2 X .020	899 X 13 X .50	8/11	ZWEP35811MC	002684	ZWEP35811MCB25	005234	ZWEP35811MCB	005272
44 ⁷ / ₁₆ X 1/2 X .020	1140 X 13 X .50	8/11	ZWEP44811MC	002486	ZWEP44811MCB25	002462	ZWEP44811MCB	002455
1216 - Cut Materials 3/16" and Thinner								
27 ³ / ₁₆ X 1/2 X .020	691 X 13 X .50	12/16	ZWEP271216MC	002691	ZWEP271216MCB25	005289	ZWEP271216MCB	005326
28 ¹³ / ₁₆ X 1/2 X .020	732 X 13 X .50	12/16	ZWEP281216MC	002707	ZWEP281216MCB25	005296	ZWEP281216MCB	005333
30 ³ / ₁₆ X 1/2 X .020	776 X 13 X .50	12/16	ZWEP301216MC	005630	ZWEP301216MCB25	005661	ZWEP301216MCB	005692
32 ⁷ / ₁₆ X 1/2 X .020	835 X 13 X .50	12/16	ZWEP321216MC	002714	ZWEP321216MCB25	005302	ZWEP321216MCB	005340
35 ³ / ₁₆ X 1/2 X .020	899 X 13 X .50	12/16	ZWEP351216MC	002721	ZWEP351216MCB25	005319	ZWEP351216MCB	005357
44 ⁷ / ₁₆ X 1/2 X .020	1140 X 13 X .50	12/16	ZWEP441216MC	002738	ZWEP441216MCB25	002745	ZWEP441216MCB	002752



METAL BI-METAL

MASTER COBALT® VARIABLE PITCH

Featuring bi-metal construction for long blade life and variable pitch teeth for efficient, reduced vibration cutting. Available in standard .020"/.50mm.

For longest blade life, the maximum recommended blade speed is 285 FPM.

Applications

- ▼ Electrical Conduit
- ▼ Strut
- ▼ Threaded Rod
- ▼ Stainless steel
- ▼ Pipe
- ▼ Tubing
- ▼ Solids
- ▼ Structural Pipes
- ▼ Machinable Metals
- ▼ PVC
- ▼ Cast Iron

Benefits

- ▼ Variable pitch teeth allow for a broader range of applications
- ▼ Tooth design reduces cutting vibration
- ▼ Shock resistant bi-metal teeth efficiently cut machinable metals
- ▼ Tooth design leaves a clean, weldable finish



Length x Width x Thickness		TPI	3/box		25/Box		Bulk 100/Box	
in	mm		Model	Part	Model	Part	Model	Part
Variable Pitch								
27 ³ / ₁₆ X 1/2 X .020	691 X 13 X .50	14/18	ZWEP271418MC	001823	ZWEP271418MCB25	005395	ZWEP271418MCB	001847
28 ¹³ / ₁₆ X 1/2 X .020	732 X 13 X .50	10/14	ZWEP281014MC	001755	ZWEP281014MCB25	005364	ZWEP281014MCB	001786
28 ¹³ / ₁₆ X 1/2 X .020	732 X 13 X .50	14/18	ZWEP281418MC	001748	ZWEP281418MCB25	005401	ZWEP281418MCB	001779
32 ⁷ / ₁₆ X 1/2 X .020	835 X 13 X .50	10/14	ZWEP321014MC	001861	ZWEP321014MCB25	005371	ZWEP321014MCB	003292
32 ⁷ / ₁₆ X 1/2 X .020	835 X 13 X .50	14/18	ZWEP321418MC	001892	ZWEP321418MCB25	005418	ZWEP321418MCB	003308
35 ³ / ₁₆ X 1/2 X .020	899 X 13 X .50	10/14	ZWEP351014MC	003049	ZWEP351014MCB25	005388	ZWEP351014MCB	003445
35 ³ / ₁₆ X 1/2 X .020	899 X 13 X .50	14/18	ZWEP351418MC	003056	ZWEP351418MCB25	005425	ZWEP351418MCB	003452
44 ⁷ / ₁₆ X 1/2 X .020	1140 X 13 X .50	10/14	ZWEP441014MC	001175	ZWEP441014MCB25	002356	ZWEP441014MCB	002233
44 ⁷ / ₁₆ X 1/2 X .020	1140 X 13 X .50	14/18	ZWEP441418MC	001182	ZWEP441418MCB25	002295	ZWEP441418MCB	002240
44 ⁷ / ₁₆ X 1/2 X .025	1140 X 13 X .64	10/14	ZWEP44251014	001953	ZWEP44251014B25	001991	ZWEP44251014WB	005586
44 ⁷ / ₁₆ X 1/2 X .025	1140 X 13 X .64	14/18	ZWEP44251418	001960	ZWEP44251418B25	002004	ZWEP44251418WB	005593



STRAIGHT PITCH BI-METAL

Featuring bi-metal construction for long blade life and straight pitch teeth for better chip clearance and fast cutting. Available in standard .020"/.50mm.

For longest blade life, the maximum recommended blade speed is 285 FPM.

Applications

- ▼ Electrical Conduit
- ▼ Strut
- ▼ Threaded Rod
- ▼ Stainless steel
- ▼ Pipe
- ▼ Tubing
- ▼ Solids
- ▼ Structural Pipes
- ▼ Machinable Metals
- ▼ PVC
- ▼ Cast Iron

Benefits

- ▼ Straight pitch teeth provide better chip clearance for fast cutting
- ▼ Shock resistant bi-metal teeth efficiently cut machinable metals
- ▼ Tooth design leaves a clean, weldable finish



Length x Width x Thickness		TPI	3/box		25/Box		Bulk 100/Box	
in	mm		Model	Part	Model	Part	Model	Part
Standard Pitch								
27 ³ / ₁₆ X 1/2 X .020	691 X 13 X .50	18	ZWEP2718W	001830	ZWEP2718WB25	005456	ZWEP2718WB	001854
28 ¹³ / ₁₆ X 1/2 X .020	732 X 13 X .50	24	ZWEP2824W	001762	ZWEP2824WB25	005463	ZWEP2824WB	001793
30 ³ / ₁₆ X 1/2 X .020	776 X 13 X .50	18	ZWEP3018W	005647	ZWEP3018WB25	005678	ZWEP3018WB	005708
32 ⁷ / ₁₆ X 1/2 X .020	835 X 13 X .50	14	ZWEP3214W	001908	ZWEP3214WB25	005487	ZWEP3214WB	003261
32 ⁷ / ₁₆ X 1/2 X .020	835 X 13 X .50	18	ZWEP3218W	001915	ZWEP3218WB25	005494	ZWEP3218WB	003278
32 ⁷ / ₁₆ X 1/2 X .020	835 X 13 X .50	24	ZWEP3224W	001922	ZWEP3224WB25	005500	ZWEP3224WB	003285
35 ³ / ₁₆ X 1/2 X .020	899 X 13 X .50	14	ZWEP3514W	003018	ZWEP3514WB25	005524	ZWEP3514WB	003414
35 ³ / ₁₆ X 1/2 X .020	899 X 13 X .50	18	ZWEP3518W	003025	ZWEP3518WB25	005531	ZWEP3518WB	003421
35 ³ / ₁₆ X 1/2 X .020	899 X 13 X .50	24	ZWEP3524W	003032	ZWEP3524WB25	005548	ZWEP3524WB	003438
44 ⁷ / ₁₆ X 1/2 X .020	1140 X 13 X .50	14	ZWEP4414W	001212	ZWEP4414WB25	002318	ZWEP4414WB	002165
44 ⁷ / ₁₆ X 1/2 X .020	1140 X 13 X .50	18	ZWEP4418W	001229	ZWEP4418WB25	002301	ZWEP4418WB	002172
44 ⁷ / ₁₆ X 1/2 X .020	1140 X 13 X .50	24	ZWEP4424W	001236	ZWEP4424WB25	005579	ZWEP4424WB	002189





MORSE HAND SAWS AND BLADES

Blade Type Application

Hack Saw Blades

Metal

Bi-Metal Used to cut pipe, tubing solids, wood, plastic or machinable metals.

Hack Saw Frames

Hack Saw Frames For use with hack saw blades including a mini for tight spaces.

Specialty Hand Saws

PVC/ABS
Saws & Blades Designed to cut PVC and ABS pipe quickly and efficiently.

Jab Saw Heavy duty, ergonomic handle for use with reciprocating saw blades.

HACK SAW BLADES & FRAMES BI-METAL



BI-METAL HACK SAW BLADES

Bi-metal hack blades will bend and flex, resisting shattering for safer sawing and longer lasting blades. Use to cut pipe, tubing or any machinable metal.

Features

- ▼ Vacuum heat treating
- ▼ Straight blade body
- ▼ Bi-metal construction
- ▼ Made in USA

Benefits

- ▼ Harder edge for fast cutting
- ▼ Greater beam strength
- ▼ Long cutting life
- ▼ Heat and wear resistant
- ▼ Flexible to prevent shattering during use



TPI	in			mm			2/Card - 5/Pack		10/Card		100/Tube		100/Box	
	Length	Width	Thickness	Length	Width	Thickness	Model	Part	Model	Part	Model	Part	Model	Part
Straight Pitch														
18	12	½	.020	300	12.7	.5	HHCB1218	304047	HHB1218T10	302180	HHB1218T100	300117	HHB1218	362184
24	12	½	.020	300	12.7	.5	HHCB1224	304054	HHB1224T10	302241	HHB1224T100	300124	HHB1224	362245
32	12	½	.020	300	12.7	.5	HHCB1232	304108	HHB1232T10	302326	HHB1232T100	300131	HHB1232	362320

Note: 100/Box for Variable and Straight Pitch blades must be ordered by blade in multiples of 100



CONTRACTOR HIGH TENSION

Benefits

- ▼ Exceptionally light for handling ease
- ▼ Aluminum frame offers extra blade storage space

Product	Frame 1/Card		TPI	Blade Included			Length	mm		
	Model	Part		in	Length	Width		Thickness	Length	Width
Contractor High Tension	HHBF04	300056	24	12	½	.020	300	12.7	.5	



MINI

Product	Frame 1/Card - 5/Pack		TPI	Blade Included			Length	mm		
	Model	Part		in	Length	Width		Thickness	Length	Width
Mini	HHBF05	330077	24	10	½	.020	250	12.7	.5	



SPECIALTY HAND SAWS



PVC/ABS SAW AND REPLACEMENT BLADES

A handy carbon steel saw for plumbers, electricians and DIY. These saws are light and comfortable with replaceable spring-tempered steel blades. Cuts on the pull stroke for quick, accurate cutting action.

Applications

- ▼ PVC
- ▼ Plastic
- ▼ Wood

Benefits

- ▼ Spring tempered carbon steel blade for superior wear resistance and long life
- ▼ Tooth hardness 65Rc for cutting PVC/ABS
- ▼ Precision-milled teeth for smooth cutting
- ▼ Comfort-grip cast aluminum handle
- ▼ Single screw attachment - no tools required for blade changes

Product	Frame 1/Card			Blade Included					
	Model	Part	TPI	in			mm		
				Length	Width	Thickness	Length	Width	Thickness
12" PVC/ABS Saw	HPVC1201	330107	10	12	2½	.370	305	63.5	9.4
18" PVC/ABS Saw	HPVC1801	330114	10	18	2½	.370	450	63.5	9.4
	Blade 1/Card			Replacement Blades					
PVC/ABS Blade	HPVC812	330121	10	12	2½	.370	305	63.5	9.4
PVC/ABS Blade	HPVC818	330138	10	18	2½	.370	450	63.5	9.4

JABSAW

JAB SAWS

Heavy duty, ergonomic handle to use with either a reciprocating or a hack saw blade. Allows for quick blade changes for various applications.



Product	Handle 1/Card			Blade Included					
	Model	Part	TPI	in			mm		
				Length	Width	Thickness	Length	Width	Thickness
Jab Saw	JSHRBC01	397063	6	6	¾	.050	152	20	1.3

WE ARE MORSE

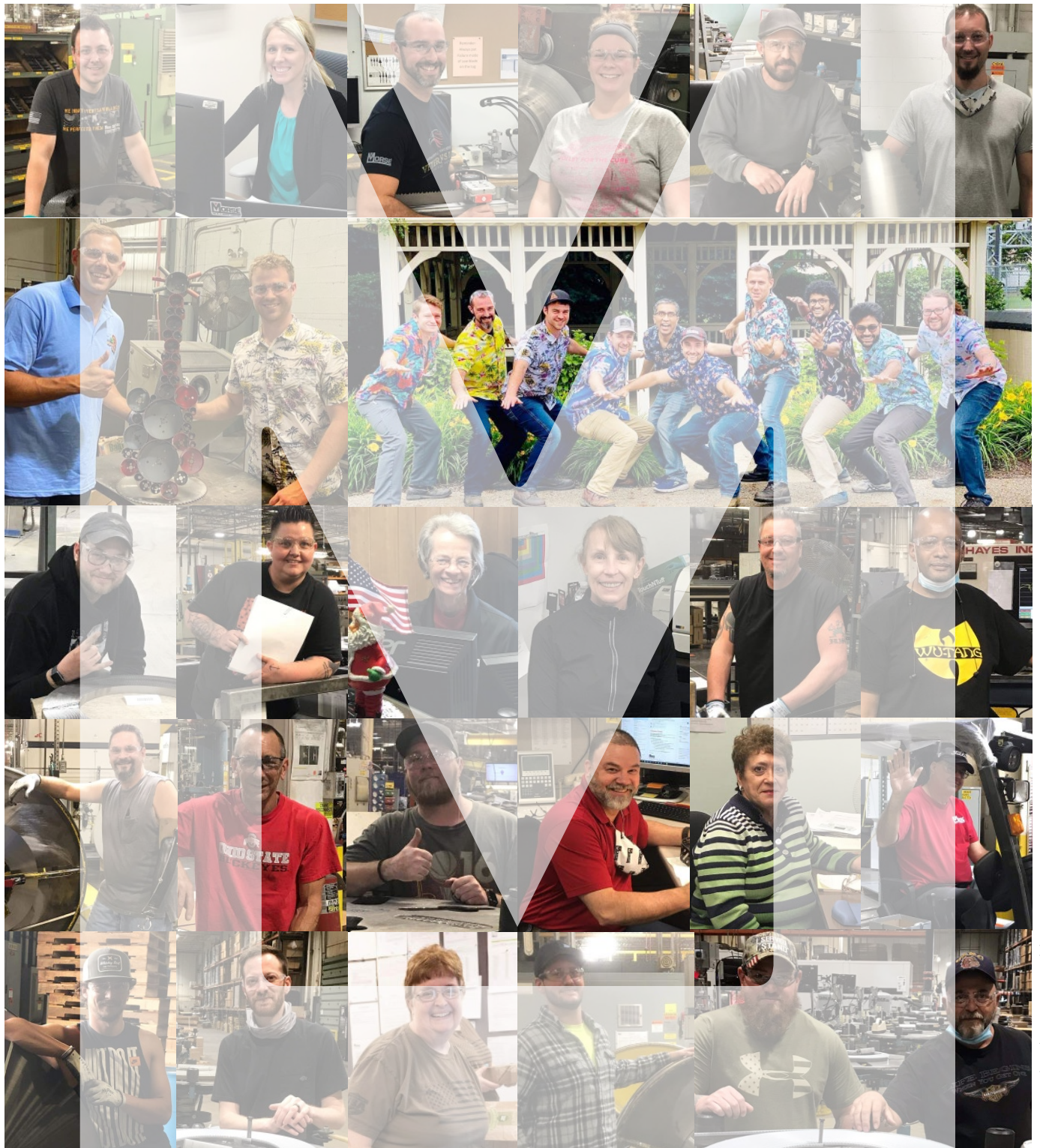

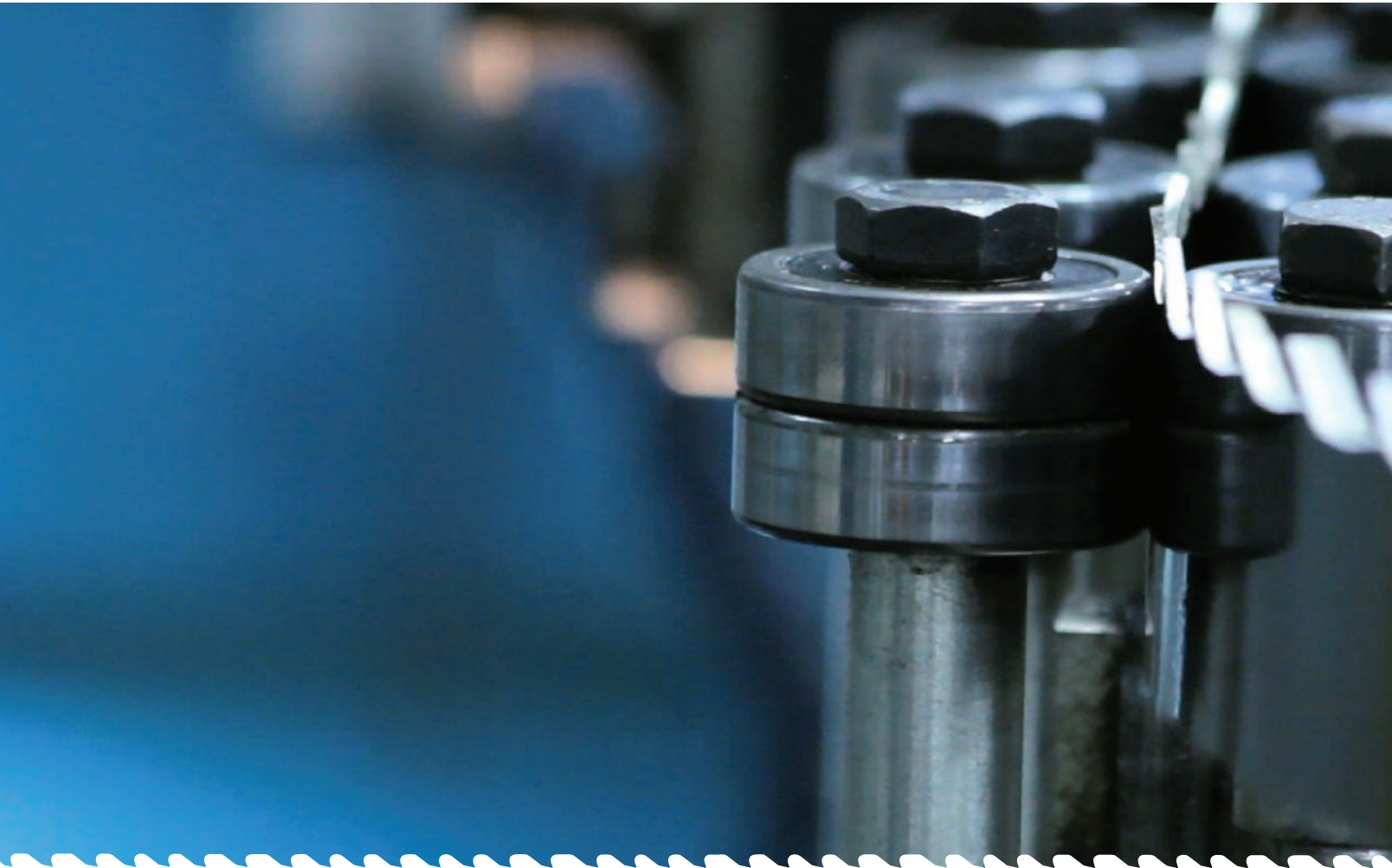

WARNING ABOUT SAW BLADE USAGE

CUTTING TOOLS CAN SHATTER AND/OR BREAK UNDER IMPROPER OR SEVERE USE. WEAR SAFETY EQUIPMENT, PARTICULARLY GOGGLES, GLOVES AND HEARING PROTECTION, AT ALL TIMES IN THE VICINITY OF THEIR USE. ALWAYS FOLLOW BAND SAW MACHINE MANUFACTURERS' RECOMMENDATIONS.

THE M. K. MORSE COMPANY WARRANTY

The M. K. Morse Company warrants each new product manufactured and sold by it or one of its authorized distributors only against defects in workmanship and/or materials under normal service, proper installation and use. THIS WARRANTY IS LIMITED TO REPAIR OR REPLACEMENT OF VERIFIED DEFECTIVE PRODUCTS AND EXCLUDES ANY AND ALL IMPLIED WARRANTY OF MERCHANTABILITY AND ALL RISK AND LIABILITY WHATSOEVER RESULTING FROM ANY USE OF SAID PRODUCTS, INCLUDING INCIDENTAL AND CONSEQUENTIAL DAMAGES. THERE ARE NO WARRANTIES WHICH EXTEND BEYOND THE DESCRIPTION ON THE FACE THEREOF. The provisions of this warranty and limitation of liability shall not be modified in any respect except by written document signed by an officer of The M. K. Morse Company.





THE M. K. MORSE COMPANY

WAREHOUSE ADDRESSES

NORTH AMERICA

OHIO

1101 – 11th Street SE
Canton, OH 44707
Phone: 330-453-8187

CALIFORNIA

7900 Balboa Blvd, Hanger B6
Van Nuys, CA 91406
Phone: 818-510-0601

(To get to the CA warehouse turn from Balboa Blvd. on to Stagg Street and then enter the parking lot on the left)

CANADA

4265 Phillips Ave
Burnaby BC V5A-2X4
Phone: (604) 942-1917

EUROPE

FINLAND

Laippatie 3
FIN-00880 Helsinki Finland
Phone: 011-358-96 12 2740

U. K.

Unit 3 The Crossings, Crosshills
North Yorkshire England BD20 7
Phone: 011-441-535-634280

ASIA

INDIA

MK MORSE COMPANY INDIA PVT LTD
GAT NO - 624 / 9, PLOT NO - 5,
GALA NO G-11, INDRAYANI INDUST PREM
CO-OP SOC LTD, KURLI, TAL-KHED
PUNE, MAHARASHTRA 410501
Phone: 91-9422-3300-36





PHONE: (330) 453-8187
HOTLINE: (800) 733-3377
FAX: (330) 453-1111
FAX HOTLINE: (800) 729-1112
EMAIL: mkmorse@mkmorse.com

WEBSITES

mkmorse.com
bladewizard.com

SOCIAL MEDIA



MAILING ADDRESS

P. O. BOX 8677
Canton, OH 44711 USA

SHIPPING ADDRESS

1101 – 11th ST SE
Canton, OH 44707 USA

