

Precision in Every Dimension

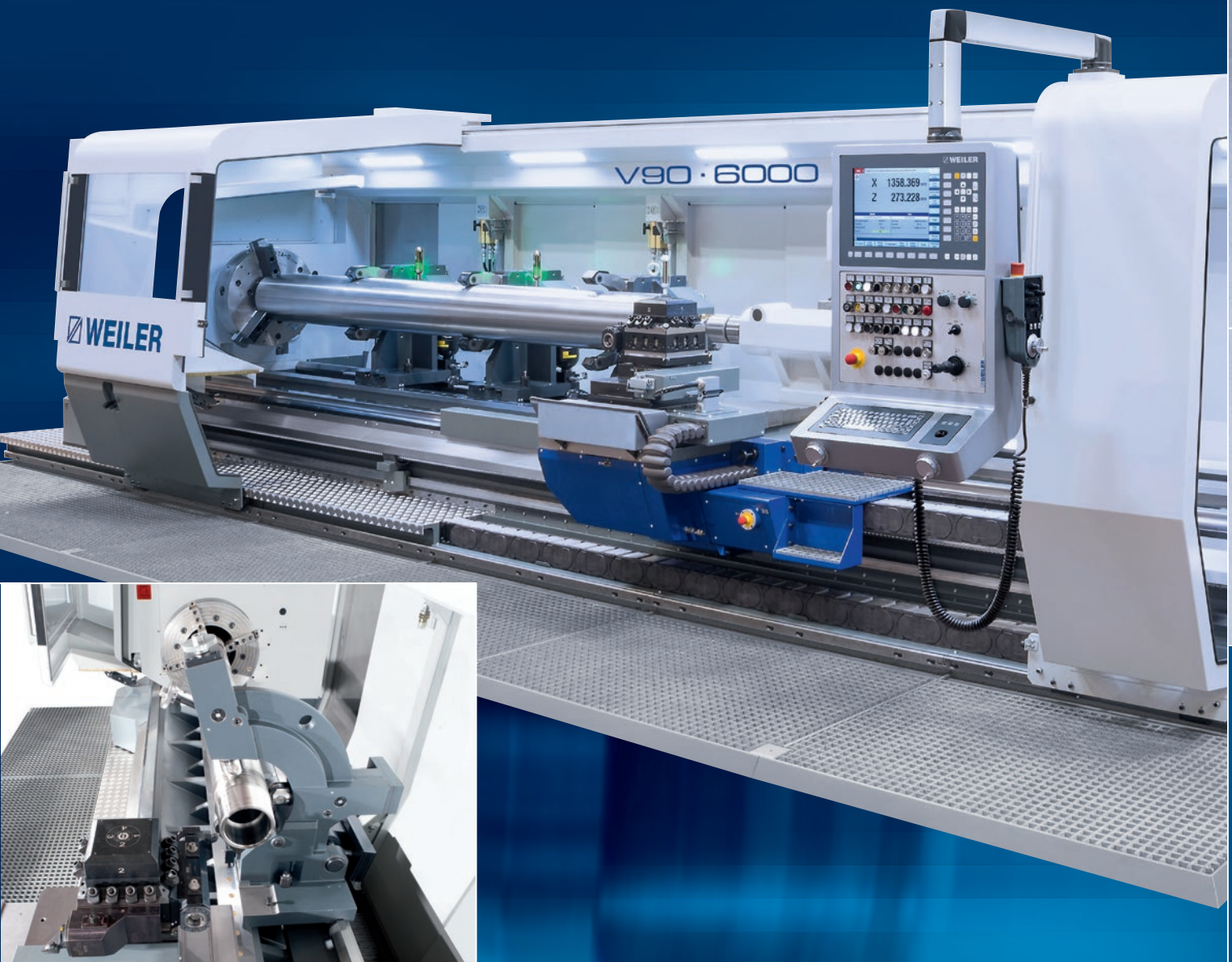

# V-Series

## 4-Way Precision Lathe with Automated Cycles

 **WEILER**

[www.weiler.de](http://www.weiler.de)

BLUECOMPETENCE  
Alliance Member

Partner der Nachhaltigkeitsinitiative  
des Maschinen- und Anlagenbaus

Service

Radial Drilling Machines

CNC Lathes

Cycle-Controlled Lathes

Tool Room Lathes / Semi-Cycle Controlled Lathes

# V90 / V110: Limitless Economic Efficiency for All Lengths

The Weiler 4-way precision lathe with automated cycles embodies the implementation of the Weiler cycle controller, that is well-known and proven from over a thousand E-Series installations, into a 4-way bed lathe.

The V-Series has been specially developed for the economic machining of long workpieces. To enable this, the slides can over-run the steady rest and tailstock.

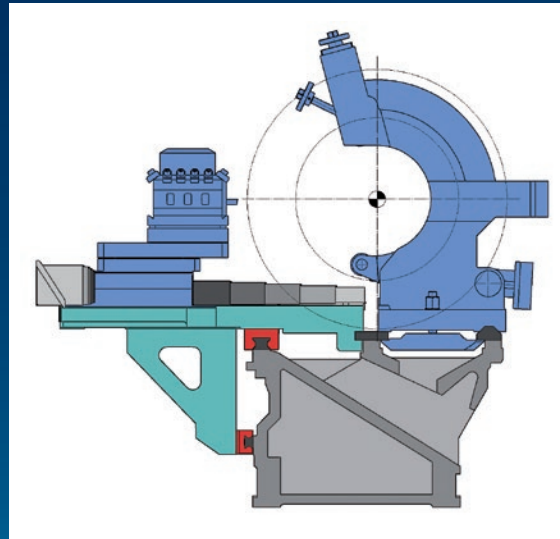

The machine takes its name from the four guideways along which the slides, tailstock and steady rest are moved. Precise, anti-friction bearings on a heavy-duty and torsion-resistant bed ensure the utmost positioning accuracy of the bed slides. The tailstocks and steady rest are precisely guided on hardened and finely-ground steel rails that are screwed on to the machine.

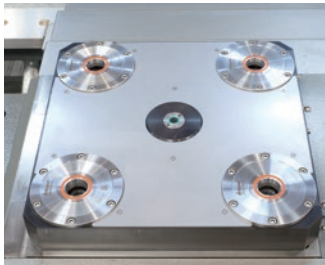

The design provides the straight-forward and precise change-over of the various tooling systems that range from tool turret, boring block and milling attachment through to a grinding unit on a quick-release plate.

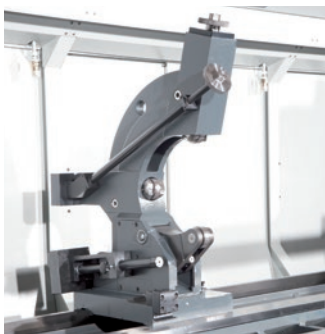

Steady rests open version (drive through version)

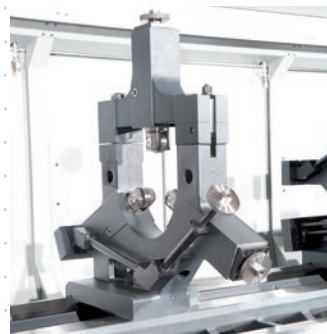

Steady rests closed version (non drive through version)

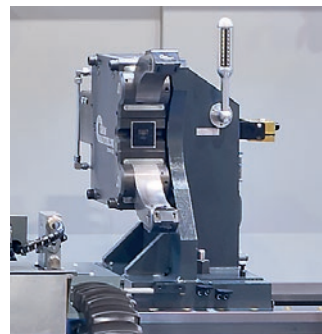

Steady rests self-centering version

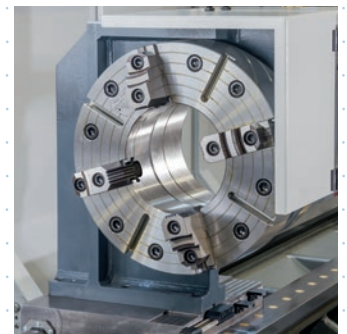

Steady rests with independent 4-jaw chuck or 3-jaw chuck

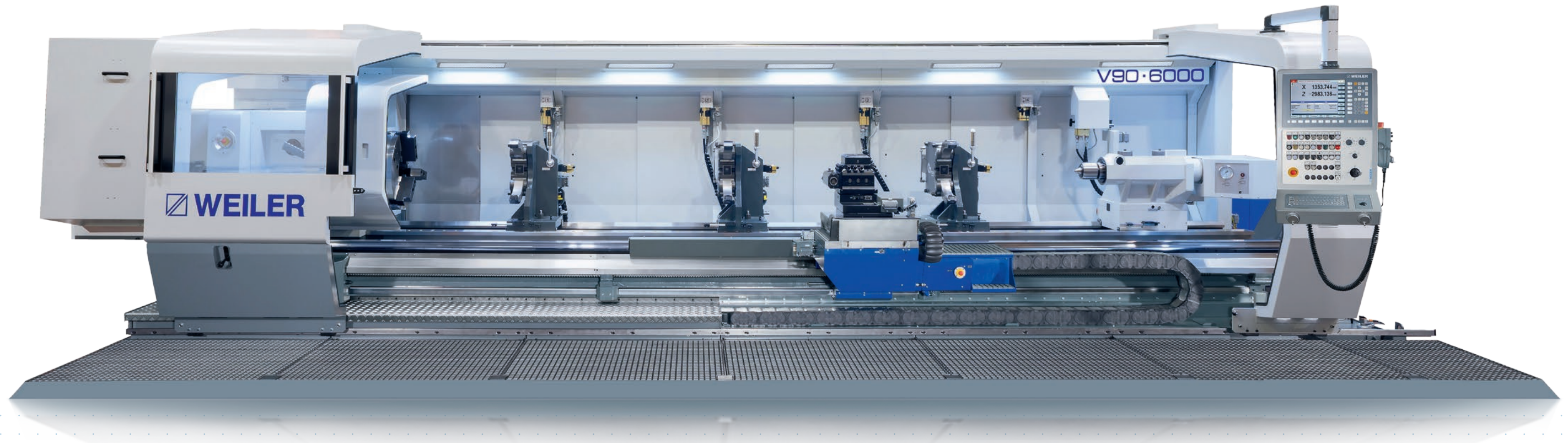

## Fast and simple communication between man and machine

Even without prior programming knowledge, the smart WEILER software guides the operator through the program. Using automated cycles, you can control the V-Series like a “manually operated” machine. Or you can completely program the workpiece contour with the assistance of the geometry processor that can automatically calculate the points of intersection. For further information, please refer to the separate WEILER control brochure.

### The three basic principles for working with all E-series machines

- 1) Simple workpieces are processed in the same way as with a conventional machine, only more efficiently.
- 2) Elaborate parts are processed in the same way as with a conventional machine, only faster.
- 3) Complex parts are processed in the same way as with a CNC machine, only easier.

### Data transfer interfaces

- ▶ V24 / RS232
- ▶ USB
- ▶ Network-compatible



15" screen and additional membrane keyboard with short-stroke keys

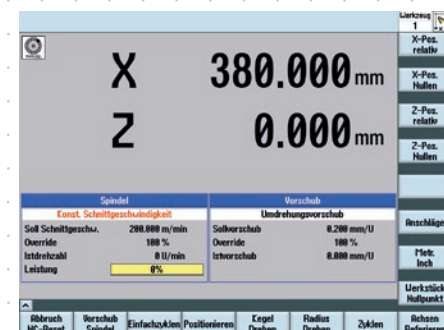

### Straightforward input and display of machine data

Machine and processing data are entered according to practical requirements and are clearly displayed.

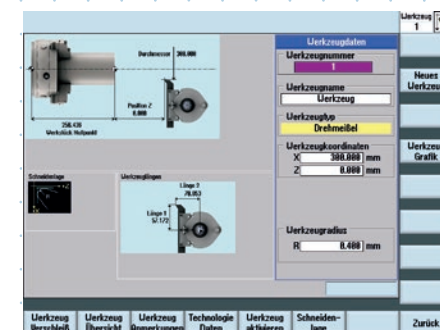

### Tool management

Simple, menu-controlled input and management of tool data with the capability of setting-up a user-specific technology database.

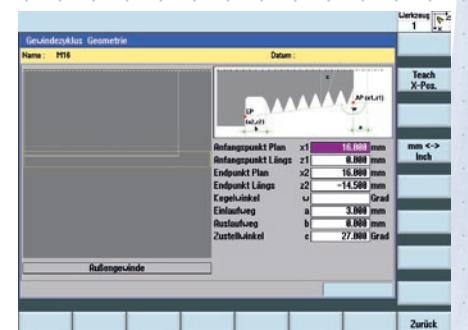

### Thread cutting cycle

Only little data is required for the input of the thread geometry.

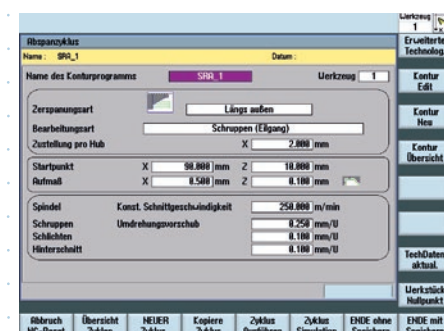

### Cutting cycle technology

Cutting is possible longitudinally and cross-wise with any desired technology.

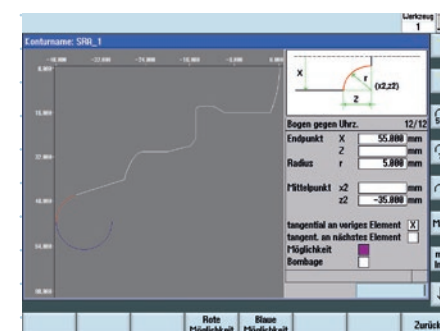

### Cutting cycle geometry

The contour is generated by stringing together simple contour elements. The calculation of the points of intersection occurs automatically.

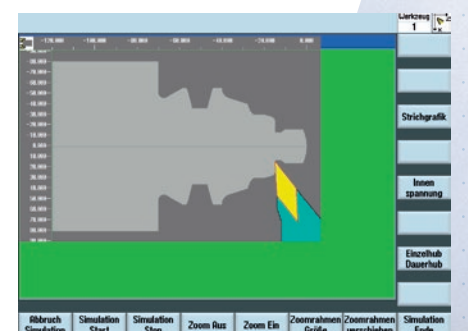

### Simulation

The machining of the workpiece can be simulated through wire models or solid models.

# Perfect Solution for a Wide Range of Applications

Field of application: oil and gas industry

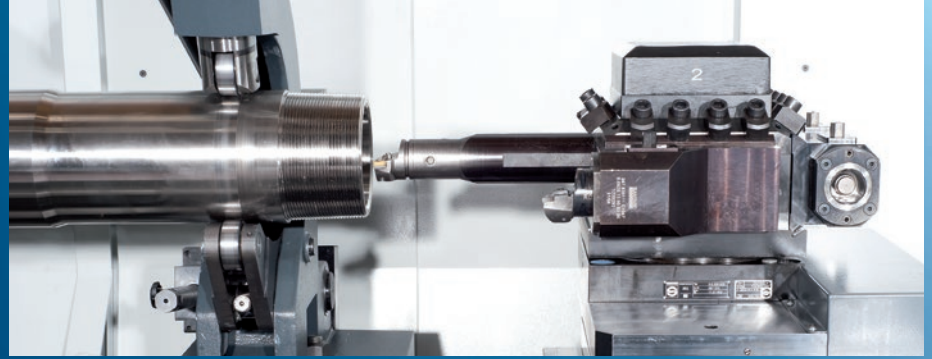

Field of application: wind energy

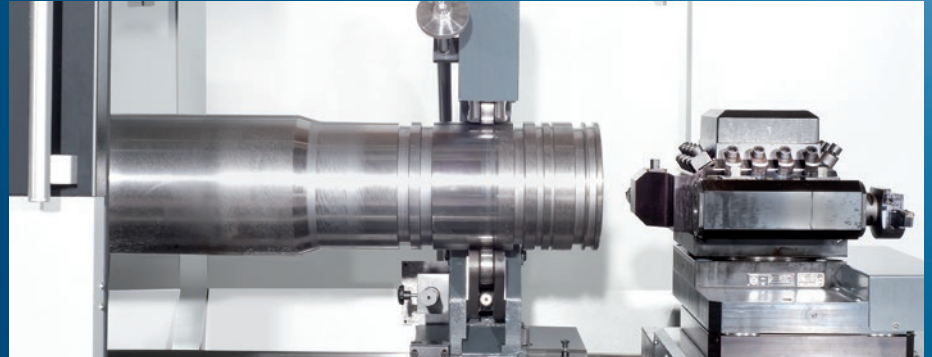

Field of application: shipbuilding



Field of application: hydraulics



# Technical Data

Working Range		V90	V110
Distance between centers	mm	3,000–12,000	3,000–12,000
Swing over bed	mm	940	1,160
Swing over cross slide	mm	590	810
Cross slide travel	mm	580	580
Width of bed	mm	900	900

Main Spindle			
Spindle nose according to DIN 55027 (26) (DIN ISO 702-3)	size	15 (20)	15 (20)
Spindle bore	mm	165	165
Other spindle bores	mm	262/362	262/362
Spindle diameter in front bearing	mm	235/330/448	235/330/448

Hauptantrieb			
Drive power at 60 %/100 %	kW	45/37	45/37
Max. torque at spindle	Nm	8,000	8,000
Speed range	rpm	1–900	1–900

Feed Range			
Feed force longitudinal	N	20,000	20,000
Rapid traverse Z/X	m/min	10/5	10/5
Feed range	mm/rev	0.001–50	0.001–50

Thread Cutting Range			
Metric threads	mm	0.1–2,000	0.1–2,000
Inch threads	TPI	112–1/64	112–1/64

Tailstock			
Tailstock quill diameter	mm	140	140 (180)
Tailstock quill taper	MT	6	6 (metr. 100)

Weights			
Weight approx	kg	15,000/27,000	16,000/28,000

Machine Accuracy			
Acceptance accuracy	DIN	8606/8607	8606/8607



WEILER Werkzeugmaschinen GmbH  
 Friedrich K. Eisler Strasse 1  
 D-91448 Emskirchen (Germany)  
 Telephone +49 (0)9101-705-0  
 Fax +49 (0)9101-705-122  
 info@weiler.de • www.weiler.de