



Peddinghaus

Peddinghaus Anlagen & Maschinen GmbH

Peddinghaus Anlagen & Maschinen GmbH
Hasslinghauser Str. 156 • D-58285 Gevelsberg
Tel. +49 (0) 2332 / 6646-20/21/22/23/24
Fax +49 (0) 2332 / 6646-46
teile-pam@peddy.de • www.peddy.de

Grüne Serie • Green Series • Série verte

für Modelle der heutigen Generation:
for machines of the current generation:
pour machines de la génération actuelle:

Peddicat 380 • 500

Peddimax 602 • 1002

Peddiworker 502 • 802

Hydraulic 280 • 502 • 1001

für ältere Modelle:
for older machine types:
pour modèles plus anciens:

Peddicat 361

Peddiworker 501 • 801 • 1000 G

Peddimaster 100/160 • 110/170 • 800/1100 • 1100/1700

Peddimax 600 • 601 • 800 • 801 • 110/140

Hydraulic 100 • 301 • 501 • 800 • 1000

210 Super 16 • 20 • 210 Standard 16

Forax 80 • 100 • 1000

225 B/ 16 • 20 • 80 • 100

225 H/ 15 • 20

Stempel und Matrizen zur Schnellspann-Vorrichtung

Punches and dies for the quick-change punching attachment

Poinçons et matrices pour utilisation dans le dispositif de serrage rapide

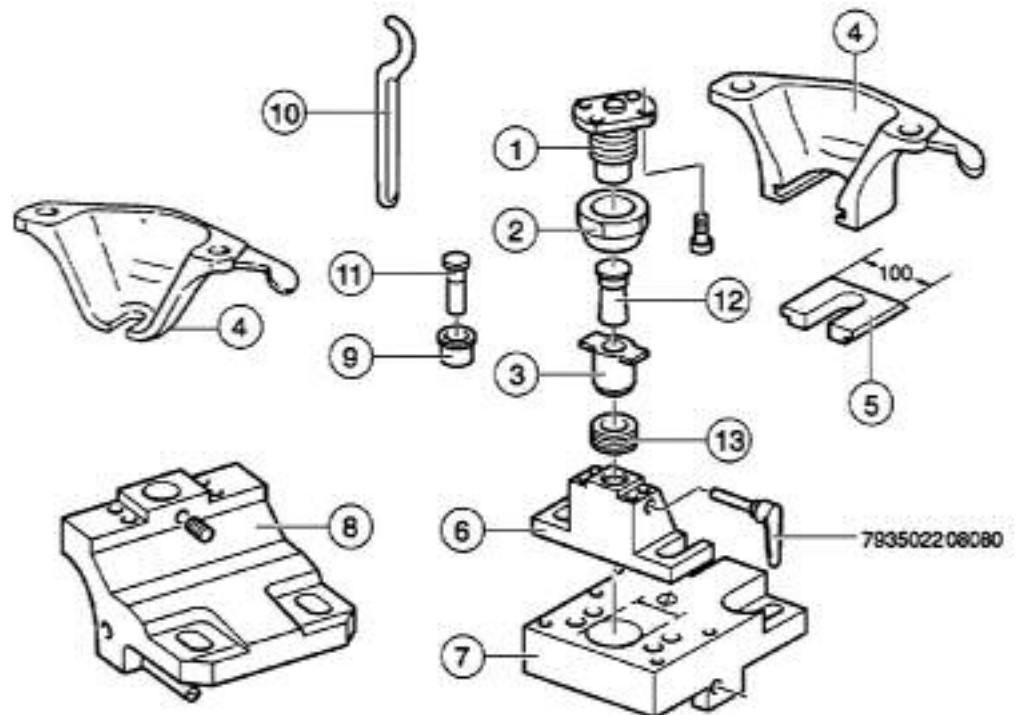

Grüne Serie • Green Series • Série verte

Rundstempel
 round punch
 poinçon rond

Nr. 2

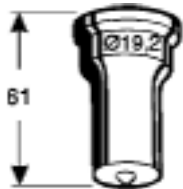

Rundstempel
 round punch
 poinçon rond

Nr. 5

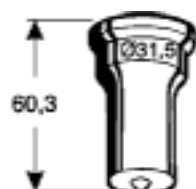

Rundmatrize
 round die
 matrice ronde

Nr. 3

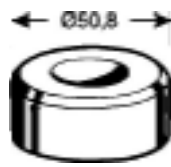

Rundmatrize
 round die
 matrice ronde

Nr. 3

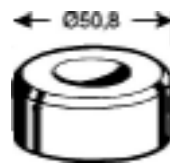

Winkelstahlmatrize
 offset round die
 matrice ronde décentrée

Nr. 14

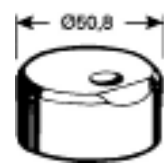

Artikel-Nr. Artikel-Nr. Artikel-Nr. Artikel-Nr. Artikel-Nr.

- 3,0 64002 1030
- 3,2 64002 1032
- 3,5 64002 1035
- 4,0 64002 1040
- 4,2 64002 1042
- 4,5 64002 1045
- 5,0 64002 1050
- 5,5 64002 1055
- 6,0 64002 1060
- 6,5 64002 1065
- 7,0 64002 1070
- 7,5 64002 1075
- 8,0 64002 1080
- 8,5 64002 1085
- 9,0 64002 1090
- 9,5 64002 1095
- 10,0 64002 1100
- 10,5 64002 1105
- 11,0 64002 1110
- 11,5 64002 1115
- 12,0 64002 1120
- 12,5 64002 1125
- 13,0 64002 1130
- 13,5 64002 1135
- 14,0 64002 1140
- 14,5 64002 1145
- 15,0 64002 1150
- 15,5 64002 1155
- 16,0 64002 1160
- 16,5 64002 1165
- 17,0 64002 1170
- 17,5 64002 1175
- 18,0 64002 1180
- 18,5 64002 1185
- 19,0 64002 1190

- 17,5 64005 1175
- 18,0 64005 1180
- 18,5 64005 1185
- 19,0 64005 1190
- 19,5 64005 1195
- 20,0 64005 1200
- 20,5 64005 1205
- 21,0 64005 1210
- 21,5 64005 1215
- 22,0 64005 1220
- 22,5 64005 1225
- 23,0 64005 1230
- 23,5 64005 1235
- 24,0 64005 1240
- 24,5 64005 1245
- 25,0 64005 1250
- 25,5 64005 1255
- 26,0 64005 1260
- 26,5 64005 1265
- 27,0 64005 1270
- 27,5 64005 1275
- 28,0 64005 1280
- 28,5 64005 1285
- 29,0 64005 1290
- 29,5 64005 1295
- 30,0 64005 1300
- 30,5 64005 1305
- 31,0 64005 1310
- 31,5 64005 1315
- 32,0 64005 1320

- 3,2 64203 1032
- 3,4 64203 1034
- 3,7 64203 1037
- 4,2 64203 1042
- 4,4 64203 1044
- 4,7 64203 1047
- 5,2 64203 1052
- 5,7 64203 1057
- 6,2 64203 1062
- 6,7 64203 1067
- 7,2 64203 1072
- 7,7 64203 1077
- 8,2 64203 1082
- 8,7 64203 1087
- 9,2 64203 1092
- 9,7 64203 1097
- 10,2 64203 1102
- 10,7 64203 1107
- 11,2 64203 1112
- 11,7 64203 1117
- 12,2 64203 1122
- 12,7 64203 1127
- 13,2 64203 1132
- 13,7 64203 1137
- 14,2 64203 1142
- 14,7 64203 1147
- 15,2 64203 1152
- 15,7 64203 1157
- 16,2 64203 1162
- 16,7 64203 1167
- 17,2 64203 1172
- 17,7 64203 1177
- 18,2 64203 1182
- 18,7 64203 1187
- 19,2 64203 1192
- 19,7 64203 1197

- 20,2 64203 1202
- 20,7 64203 1207
- 21,2 64203 1212
- 21,7 64203 1217
- 22,2 64203 1222
- 22,7 64203 1227
- 23,2 64203 1232
- 23,7 64203 1237
- 24,2 64203 1242
- 24,7 64203 1247
- 25,2 64203 1252
- 25,7 64203 1257
- 26,2 64203 1262
- 26,7 64203 1267
- 27,2 64203 1272
- 27,7 64203 1277
- 28,2 64203 1282
- 28,7 64203 1287
- 29,2 64203 1292
- 29,7 64203 1297
- 30,2 64203 1302
- 30,7 64203 1307
- 31,2 64203 1312
- 31,7 64203 1317
- 32,2 64203 1322
- 32,7 64203 1327
- 33,2 64203 1332

- 5,7 64214 1057
- 6,2 64214 1062
- 6,7 64214 1067
- 7,2 64214 1072
- 7,7 64214 1077
- 8,2 64214 1082
- 8,7 64214 1087
- 9,2 64214 1092
- 9,7 64214 1097
- 10,2 64214 1102
- 10,7 64214 1107
- 11,2 64214 1112
- 11,7 64214 1117
- 12,2 64214 1122
- 12,7 64214 1127
- 13,2 64214 1132
- 13,7 64214 1137
- 14,2 64214 1142
- 14,7 64214 1147
- 15,2 64214 1152
- 15,7 64214 1157
- 16,2 64214 1162
- 16,7 64214 1167
- 17,2 64214 1172
- 17,7 64214 1177
- 18,2 64214 1182
- 18,7 64214 1187
- 19,2 64214 1192
- 19,7 64214 1197
- 20,2 64214 1202
- 20,7 64214 1207
- 21,2 64214 1212
- 21,7 64214 1217
- 22,2 64214 1222
- 22,7 64214 1227
- 23,2 64214 1232
- 23,7 64214 1237
- 24,2 64214 1242
- 24,7 64214 1247

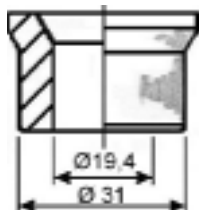

Reduzierhülse 2/5 44081 198 503
 reducing sleeve 2/5
 réducteur 2/5

Streichmaß: Seite 69
 back marks: see page
 trusquingage: voir page

Schneidspiel: Seite 67
 clearance: see page
 jeu: voir page



Grüne Serie • Green Series • Série verte			
Vierkantstempel square punch poinçon carré	Vierkantmatrize square die matrice carrée	Langlochstempel oblong punch poinçon oblong	Langlochmatrize oblong die matrice oblongue
Nr. 2	Nr. 3	Nr. 2	Nr. 3
Artikel-Nr.	Artikel-Nr.	Artikel-Nr.	Artikel-Nr.
4,0 64002 2040 5,0 64002 2050 6,0 64002 2060 7,0 64002 2070 8,0 64002 2080 9,0 64002 2090 10,0 64002 2100 11,0 64002 2110 12,0 64002 2120 13,0 64002 2130	4,2 64203 2042 5,2 64203 2052 6,2 64203 2062 6,7 64203 2067 7,2 64203 2072 7,7 64203 2077 8,2 64203 2082 8,7 64203 2087 9,2 64203 2092 9,7 64203 2097 10,2 64203 2102 10,7 64203 2107 11,2 64203 2112 11,7 64203 2117 12,2 64203 2122 12,7 64203 2127 13,2 64203 2132 13,7 64203 2137 14,2 64203 2142 14,7 64203 2147 15,2 64203 2152 15,7 64203 2157 16,2 64203 2162 16,7 64203 2167 17,2 64203 2172 17,7 64203 2177 18,2 64203 2182 18,7 64203 2187 19,2 64203 2192 19,7 64203 2197 20,2 64203 2202 20,7 64203 2207 21,2 64203 2212 21,7 64203 2217 22,2 64203 2222 22,7 64203 2227 23,2 64203 2232 23,7 64203 2237	5,0 x 10,0 64002 3 050100 5,0 x 14,0 64002 3 050140 5,5 x 10,0 64002 3 055100 5,5 x 14,0 64002 3 055140 5,5 x 19,0 64002 3 055190 6,5 x 12,0 64002 3 065120 6,5 x 18,0 64002 3 065180 7,5 x 14,0 64002 3 075140 9,0 x 14,0 64002 3 090140 9,0 x 18,0 64002 3 090180 10,0 x 14,0 64002 3 100140	5,2 x 10,2 64203 3 052102 5,7 x 10,7 64203 3 057107 5,2 x 14,2 64203 3 052142 5,7 x 14,7 64203 3 057147 5,7 x 10,2 64203 3 057102 6,2 x 10,7 64203 3 062107 5,7 x 14,2 64203 3 057142 6,2 x 14,7 64203 3 062147 5,7 x 19,2 64203 3 057192 6,2 x 19,7 64203 3 062197 6,7 x 12,2 64203 3 067122 7,2 x 12,7 64203 3 072127 6,7 x 18,2 64203 3 067182 7,2 x 18,7 64203 3 072187 7,7 x 14,2 64203 3 077142 8,2 x 14,7 64203 3 082147 9,2 x 14,2 64203 3 092142 9,7 x 14,7 64203 3 097147 9,2 x 18,2 64203 3 092182 9,7 x 18,7 64203 3 097187 10,2 x 14,2 64203 3 102142 10,7 x 14,7 64203 3 107147 11,2 x 15,2 64203 3 112152
Vierkantstempel square punch poinçon carré			
Nr. 5			
Artikel-Nr.			
14,0 64005 2140 15,0 64005 2150 16,0 64005 2160 17,0 64005 2170 18,0 64005 2180 19,0 64005 2190 20,0 64005 2200 21,0 64005 2210 22,0 64005 2220			
			Schneidspiel: Materialdicke: clearance material thickness jeu épaisseur mat. 0,2 mm bis 4 mm 0,7 mm 4 – 9 mm 1,2 mm 9 – 14 mm
			siehe Seite 67 see page voir page



Grüne Serie • Green Series • Série verte

Langlochstempel oblong punch poinçon oblong		Langlochmatrize oblong die matrice oblongue		Langlochstempel oblong punch poinçon oblong		Langlochmatrize oblong die matrice oblongue	
Nr. 5		Nr. 3		Nr. 5		Nr. 3	
—	Artikel-Nr.	—	Artikel-Nr.	—	Artikel-Nr.	—	Artikel-Nr.
5,5 x 25,0	64005 3 055250	5,7 x 25,2	64203 3 057252	12,0 x 24,0	64005 3 120240	12,2 x 24,2	64203 3 122242
		6,2 x 25,7	64203 3 062257			12,7 x 24,7	64203 3 127247
6,5 x 26,0	64005 3 065260	6,7 x 26,2	64203 3 067262	12,0 x 30,0	64005 3 120300	13,2 x 25,2	64203 3 132252
		7,2 x 26,7	64203 3 072267			12,2 x 30,2	64203 3 122302
6,5 x 30,0	64005 3 065300	6,7 x 30,2	64203 3 067302	13,0 x 26,0	64005 3 130260	12,7 x 30,7	64203 3 127307
		7,2 x 30,7	64203 3 072307			13,2 x 31,2	64203 3 132312
7,5 x 21,0	64005 3 075210	7,7 x 21,2	64203 3 077212	13,0 x 30,0	64005 3 130300	13,2 x 26,2	64203 3 132262
		8,2 x 21,7	64203 3 082217			13,7 x 26,7	64203 3 137267
7,5 x 26,0	64005 3 075260	7,7 x 26,2	64203 3 077262	14,0 x 26,0	64005 3 140260	14,2 x 27,2	64203 3 142272
		8,2 x 26,7	64203 3 082267			13,2 x 30,2	64203 3 132302
7,5 x 30,0	64005 3 075300	8,2 x 26,7	64203 3 082267	13,0 x 30,0	64005 3 130300	13,7 x 30,7	64203 3 137307
		7,7 x 30,2	64203 3 077302			14,2 x 31,2	64203 3 142312
9,0 x 26,0	64005 3 090260	8,2 x 30,7	64203 3 082307	14,0 x 26,0	64005 3 140260	14,2 x 26,2	64203 3 142262
		9,2 x 26,2	64203 3 092262			14,7 x 26,7	64203 3 147267
9,0 x 30,0	64005 3 090300	9,7 x 26,7	64203 3 097267	14,0 x 28,0	64005 3 140280	15,2 x 27,2	64203 3 152272
		9,2 x 30,2	64203 3 092302			14,2 x 28,2	64203 3 142282
10,0 x 20,0	64005 3 100200	9,7 x 30,7	64203 3 097307	16,0 x 26,0	64005 3 160260	14,7 x 28,7	64203 3 147287
		10,2 x 20,2	64203 3 102202			15,2 x 29,2	64203 3 152292
10,0 x 26,0	64005 3 100260	10,7 x 20,7	64203 3 107207	14,0 x 28,0	64005 3 140280	14,2 x 28,2	64203 3 142282
		11,2 x 21,2	64203 3 112212			14,7 x 28,7	64203 3 147287
10,0 x 30,0	64005 3 100300	10,2 x 26,2	64203 3 102262	16,0 x 26,0	64005 3 160260	15,2 x 29,2	64203 3 152292
		10,7 x 26,7	64203 3 107267			14,2 x 28,2	64203 3 142282
11,0 x 22,0	64005 3 110220	11,2 x 27,2	64203 3 112272	16,0 x 31,0	64005 3 160310	14,7 x 28,7	64203 3 147287
		10,2 x 30,2	64203 3 102302			15,2 x 29,2	64203 3 152292
11,0 x 26,0	64005 3 110260	10,7 x 30,7	64203 3 107307	18,0 x 26,0	64005 3 180260	16,2 x 26,2	64203 3 162262
		11,2 x 31,2	64203 3 112312			16,7 x 26,7	64203 3 167267
11,0 x 30,0	64005 3 110300	11,2 x 22,2	64203 3 112222	18,0 x 26,0	64005 3 180260	16,2 x 31,2	64203 3 162312
		11,7 x 22,7	64203 3 117227			16,7 x 31,7	64203 3 167317
		12,2 x 23,2	64203 3 122232	18,0 x 31,0	64005 3 180310	17,2 x 32,2	64203 3 172322
		11,2 x 26,2	64203 3 112262			18,2 x 26,2	64203 3 182262
		11,7 x 26,7	64203 3 117267	20,0 x 31,0	64005 3 200310	18,7 x 26,7	64203 3 187267
		12,2 x 27,2	64203 3 122272			19,2 x 27,2	64203 3 192272
		11,2 x 30,2	64203 3 112302	18,0 x 31,0	64005 3 180310	18,2 x 31,2	64203 3 182312
		11,7 x 30,7	64203 3 117307			18,7 x 31,7	64203 3 187317
		12,2 x 31,2	64203 3 122312	22,0 x 31,0	64005 3 220310	19,2 x 32,2	64203 3 192322
						20,2 x 31,2	64203 3 202312
						20,7 x 31,7	64203 3 207317
						21,2 x 32,2	64203 3 212322
						22,2 x 31,2	64203 3 222312
						22,7 x 31,7	64203 3 227317
						23,2 x 32,2	64203 3 232322



Schneidpiel / clearance / jeu: **0,2 mm** (bis 4 mm Materialdicke) • **0,7 mm** (4 – 9 mm Materialdicke) • **1,2 mm** (9 – 14 mm Materialdicke)



Peddinghaus Anlagen & Maschinen GmbH

Peddinghaus Anlagen & Maschinen GmbH
 Hasslinghauser Str. 156 • D-58285 Gevelsberg
 Tel. +49 (0) 2332 / 6646-20/21/22/23/24
 Fax +49 (0) 2332 / 6646-46
 teile-pam@peddy.de • www.peddy.de

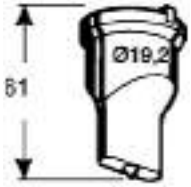
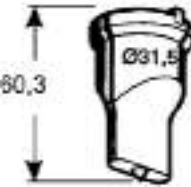
Grüne Serie • Green Series • Série verte

Langlochstempel oblong punch poinçon oblong	Langlochstempel oblong punch poinçon oblong	Langloch-Winkelstahlmatrize längs oblong offset die, longitudinal matrice oblongue décentrée	Langloch-Winkelstahlmatrize quer oblong offset die, transverse matrice oblongue décentrée
Nr. 2	Nr. 5	Nr. 14	Nr. 14
			
Artikel-Nr.	Artikel-Nr.	Artikel-Nr.	Artikel-Nr.
5,5 x 14,0 64002 3 055140		6,2 x 14,7 64214 3 062147	6,2 x 14,7 64214 4 062147
	5,5 x 25,0 64005 3 055250	6,2 x 25,7 64214 3 062257	6,2 x 25,7 64214 4 062257
	6,5 x 26,0 64005 3 065260	7,2 x 26,7 64214 3 072267	7,2 x 26,7 64214 4 072267
	7,5 x 26,0 64005 3 075260	8,2 x 26,7 64214 3 082267	8,2 x 26,7 64214 4 082267
9,0 x 14,0 64002 3 090140		9,7 x 14,7 64214 3 097147	9,7 x 14,7 64214 4 097147
	9,0 x 26,0 64005 3 090260	9,7 x 26,7 64214 3 097267	9,7 x 26,7 64214 4 097267
	10,0 x 20,0 64005 3 100200	10,7 x 20,7 64214 3 107207	10,7 x 20,7 64214 4 107207
	11,0 x 22,0 64005 3 110220	11,7 x 22,7 64214 3 117227	11,7 x 22,7 64214 4 117227
	11,0 x 26,0 64005 3 110260	11,7 x 26,7 64214 3 117267	11,7 x 26,7 64214 4 117267
	13,0 x 26,0 64005 3 130260	13,7 x 26,7 64214 3 137267	13,7 x 26,7 64214 4 137267
	14,0 x 26,0 64005 3 140260	14,7 x 26,7 64214 3 147267	14,7 x 26,7 64214 4 147267
	16,0 x 26,0 64005 3 160260	16,7 x 26,7 64214 3 167267	16,7 x 26,7 64214 4 167267

Streichmaß : siehe Seite **69**
 back marks : see page
 trusquinage: voir page

Grüne Serie • Green Series • Série verte

Rechteckstempel
 rectangular punch
 poinçon rectangulaire

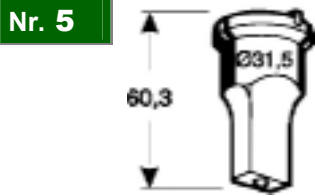

Artikel-Nr.

5,0x15	64005 5 050150
5,0x20	64005 5 050200
6,0x24	64005 5 060240
8,0x16	64005 5 080160
8,0x24	64005 5 080240
9,0x24	64005 5 090240
10,0x20	64005 5 100200
11,0x22	64005 5 110220
12,0x22	64005 5 120220
12,0x30	64005 5 120300
14,0x20	64005 5 140200
16,0x20	64005 5 160200

Rechteckmatrize
 rectangular die
 matrice rectangulaire



Artikel-Nr.

5,2x15,2	64203 5 052152
5,7x15,7	64203 5 057157
5,2x20,2	64203 5 052202
5,7x20,7	64203 5 057207
6,2x24,2	64203 5 062242
6,7x24,7	64203 5 067247
8,2x16,2	64203 5 082162
8,7x16,7	64203 5 087167
8,2x24,2	64203 5 082242
8,7x24,7	64203 5 087247
9,2x24,2	64203 5 092242
9,7x24,7	64203 5 097247
10,2x20,2	64203 5 102202
10,7x20,7	64203 5 107207
11,2x22,2	64203 5 112222
11,7x22,7	64203 5 117227
12,2x22,2	64203 5 122222
12,7x22,7	64203 5 127227
12,2x30,2	64203 5 122302
12,7x30,7	64203 5 127307
14,2x20,2	64203 5 142202
14,7x20,7	64203 5 147207
16,2x20,2	64203 5 162202
16,7x20,7	64203 5 167207

Schlüssellochstempel*
 key hole punch
 poinçon pour canon européen

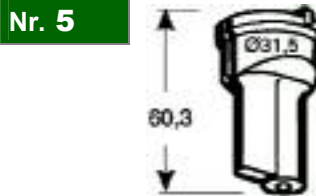

Artikel-Nr.

34,0 x Ø17,5 x 10,5
 65005 17 001



*zusätzlich erforderlich:
**Schnellspanneinsatz,
 Schlüsselloch
 42217 6 2002 02**
 f. Stempel-Schnellwechsel-
 vorrichtung – grüne Serie –
 ab 1993

*additionally required:
 quick-change punch sleeve,
 keyhole, p/n 42217 6 2002 02,
 for quick-change punching
 attachments, green series,
 supplied since 1993

Schlüssellochmatrize
 key hole die
 matrice pour canon européen



Artikel-Nr.

34,2 x Ø17,7 x 10,7
 65203 17 001

*nécessaire en plus:
 douille de serrage rapide,
 canon européen,
 réf. 42217 6 2002 02,
 pour dispositifs de serrage rapide,
 série verte, fournis depuis 1993

Eckenabrundstempel
 corner radiusing punch
 poinçon p. arrondir les angles

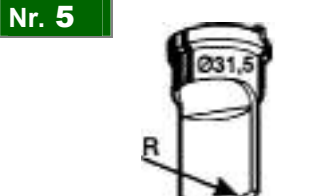

Artikel-Nr.

Radius	
5	65005 37 00050
10	65005 37 00100
15	65005 37 00150

Eckenabrundmatrize
 corner radiusing die
 matrice p. arrondir les angles

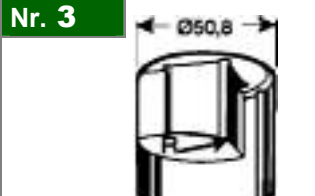

Artikel-Nr.

Radius	
5	65203 37 00050
10	65203 37 00100
14	65203 37 00140
15	65203 37 00150

Drehriegelstempel
 hasp hole punch
 poinçon trou d'espagnolette

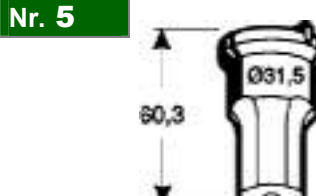

Artikel-Nr.

Ø 22,2x20,3 65005 38 222203

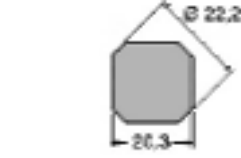

Drehriegelmatrize
 hasp hole die
 matrice trou d'espagnolette

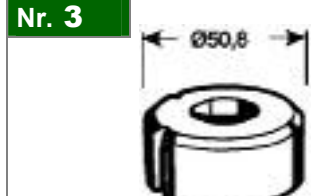

Artikel-Nr.

Ø 22,4 x20,5 65203 38 224205



Grüne Serie • Green Series • Série verte

Spezial-Stempel zum Stanzen von VA-Material
Special Punches for Punching Stainless Steel
Poinçons spéciaux pour poinçonner du matériau inox

Spezial-Rundstempel
 special round punch
 poinçon rond spécial

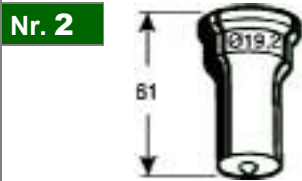

Artikel-Nr.	Artikel-Nr.
3,0	P-65002 8012 030
4,0	P-65002 8012 040
5,0	P-65002 8012 050
5,5	P-65002 8012 055
6,0	P-65002 8012 060
6,5	P-65002 8012 065
7,0	P-65002 8012 070
8,0	P-65002 8012 080
9,0	P-65002 8012 090
10,0	P-65002 8012 100
11,0	P-65002 8012 110
12,0	P-65002 8012 120
13,0	P-65002 8012 130
14,0	P-65002 8012 140
15,0	P-65002 8012 150
16,0	P-65002 8012 160
17,0	P-65002 8012 170

Rundmatrize (Standard)
 round die
 matrice ronde

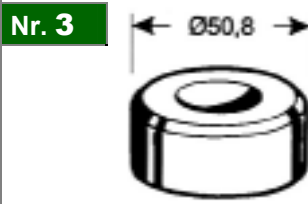

Artikel-Nr.	Artikel-Nr.
3,2	64203 1032
3,7	64203 1037
4,2	64203 1042
4,7	64203 1047
5,2	64203 1052
5,7	64203 1057
6,2	64203 1062
6,7	64203 1067
7,2	64203 1072
7,7	64203 1077
8,2	64203 1082
8,7	64203 1087
9,2	64203 1092
9,7	64203 1097
10,2	64203 1102
10,7	64203 1107

Rundmatrize (Standard)
 round die
 matrice ronde

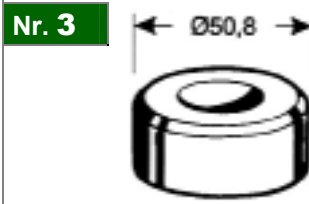

Artikel-Nr.	Artikel-Nr.
11,2	64203 1112
11,7	64203 1117
12,2	64203 1122
12,7	64203 1127
13,2	64203 1132
13,7	64203 1137
14,2	64203 1142
14,7	64203 1147
15,2	64203 1152
15,7	64203 1157
16,2	64203 1162
16,7	64203 1167
17,2	64203 1172
17,7	64203 1177
18,2	64203 1182

Spezial-Vierkantstempel
 special square punch
 poinçon carré spécial

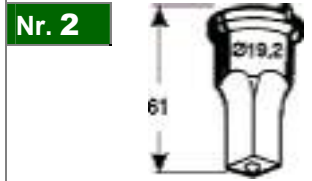

Artikel-Nr.	Artikel-Nr.
9,0	P-65002 8014 090

Vierkantmatrize (Standard)
 square die
 matrice carrée

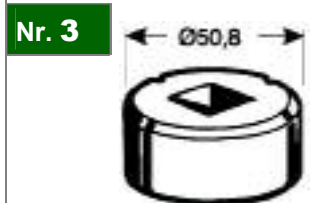

Artikel-Nr.	Artikel-Nr.
9,7	64203 2097

Spezial-Langlochstempel
 special oblong punch
 poinçon oblong spécial

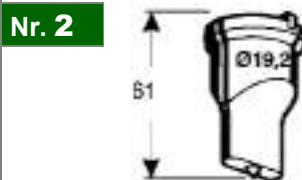

Artikel-Nr.	Artikel-Nr.
5,1x10,0	P-65002 8013 02
9,0x14,0	P-65002 8013 01
9,0x18,0	P-65002 8013 03

Langlochmatrize (Standard)
 oblong die
 matrice oblongue



Artikel-Nr.	Artikel-Nr.
9,7x14,7	64203 3 097147
9,7x18,7	64203 3 097187

Spezial-Langlochstempel
 special oblong punch
 poinçon oblong spécial

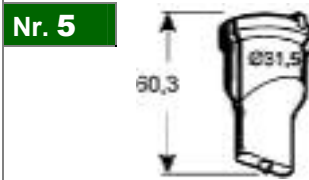

Artikel-Nr.	Artikel-Nr.
9,0x25,0	P-65005 8024 02
10,0x30,0	P-65005 8024 01
11,0x26,0	P-65005 8024 04
11,0x30,0	P-65005 8024 03

Langlochmatrize (Standard)
 oblong die
 matrice oblongue

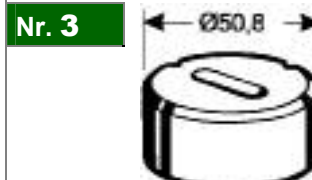

Artikel-Nr.	Artikel-Nr.
9,7x25,7	64203 3 097257
10,7x30,7	64203 3 107307
11,2x31,2	64203 3 112312
11,7x26,7	64203 3 117267
12,2x27,2	64203 3 122272
11,7x30,7	64203 3 117307
12,2x31,2	64203 3 122312