

2008  
XCB634

# Switchgear Catalogue

The power to switch

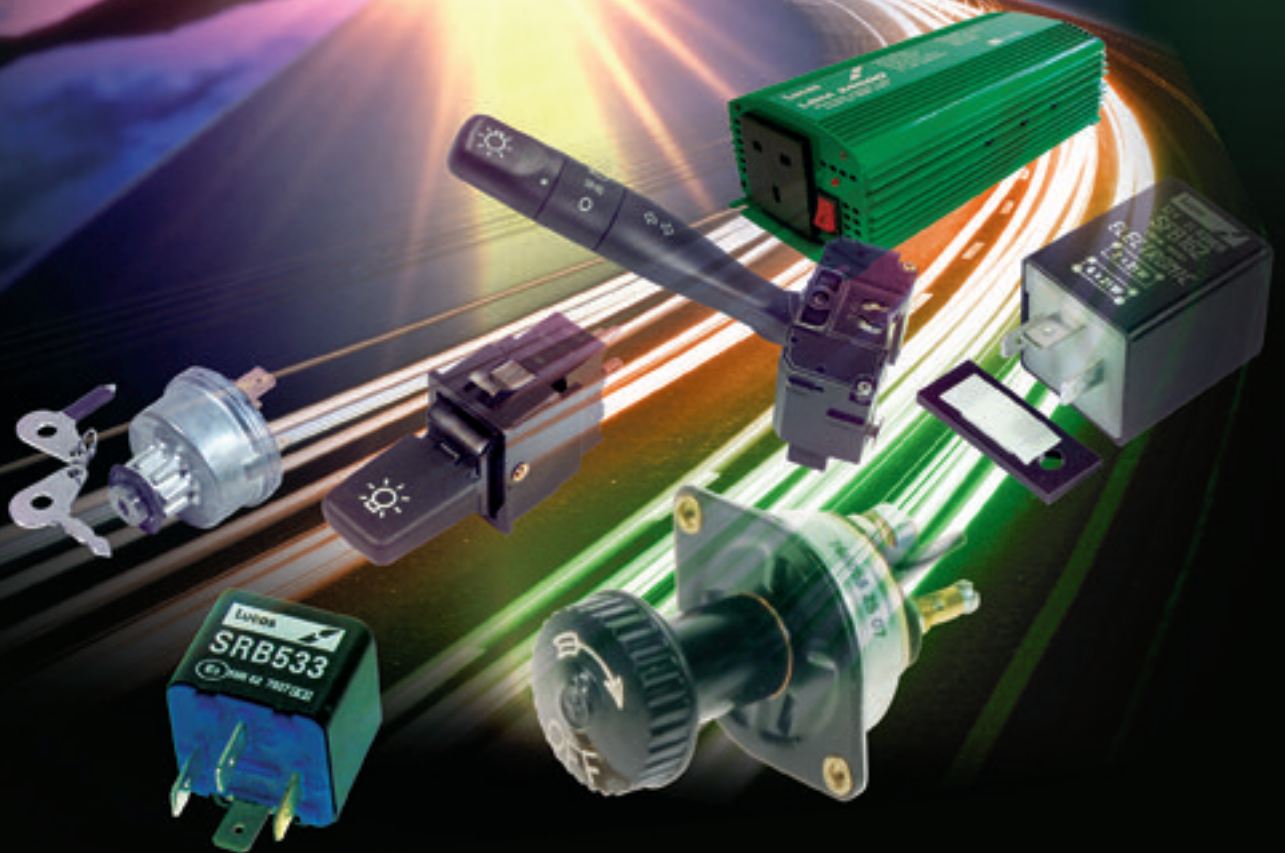

**Lucas**



*The power of EXCELLENCE*

*Driving the Lucas brand  
into the future*

Lucas Electrical

Lucas Lighting & Mirrors

Lucas Engine Management

Lucas Batteries

Lucas Starters & Alternators

Lucas Warning & Safety

Lucas Diesel



The power of EXCELLENCE



# Contents

<b>1</b>	<b>Range Overview</b>	
	Inverters and Battery Master Switches	2
	Column Switches	3
	Panel Switches	4
	Ignition Switches, Relay Switches and Accessories	5
	Range Supercessions and Deletions	6
<b>2</b>	<b>Part Number Index</b>	7
<b>3</b>	<b>Product Application and Specification</b>	
	Inverters	3.1
	Battery Master Switches	3.5
	Column Switches	3.11
	Panel Switches	3.33
	Ignition Switches	3.69
	Relay Switches	3.81
	Accessories	3.105
<b>4</b>	<b>Cross Reference</b>	4.1



# Inverters and Battery Master Switches



## Inverters

- Convert 12 volt and 24 volt direct current to 230 volt alternating current
- Ranging from 100 to 2000 watt output
- Both modified and pure sine wave inverters
- 12 volt battery charger also in the range

## Battery Master Switches

- Suitable for passenger, commercial and industrial applications
- Required for "Safe Loading Passes"
- Designed and built to the highest specifications

NEW TO RANGE		
PART NO.	DESCRIPTION	PAGE
SSB200	Battery switch 250amp with fixed 'T' key	3.8
SSB201	Battery switch 250amp emergency stop	3.9
SSB202	Battery switch 250amp with removable key	3.9
SSB203	Battery switch 250amp change over with fixed key	3.9
SSB204	Battery isolator switch, 100a 24v splash proof	3.9



# Column Switches



## Column Switches

- Enhanced range of column switches
- New range of Renault OE switches
- Strong contingent of Land Rover and classic model switches

NEW TO RANGE		
PART NO.	DESCRIPTION	PAGE
54033998	Column Switch	3.32
SPB228	RC183 Rotary connector - Rover 76	3.28
SPB326	Switch RC22 - Renault Megane	3.28
SPB327	Switch RC20 - Renault Twingo	3.28
SPB328	Switch RC40 - Renault Safrane	3.28
SPB329	Column Switch Component - Renault	3.28
SPB330	Column Switch Component - Renault Traffic	3.28
SPB331	Column Switch Component - Renault Megane	3.28
SPB332	Column Switch Component - Renault Clio	3.28
SPB333	Column Switch Component - Renault Clio	3.28
SPB334	Column Switch Component - Renault Megane	3.28
SPB335	Column Switch Component - Renault Megane	3.28
SPB336	Column Switch Component - Renault Laguna	3.28
SPB337	Column Switch Component - Renault Laguna	3.28
SPC101	Spare-striker bush assy - Rover MGTf	3.28
SPC102	Spare-striker bush assy - Rover 45	3.28
SPC103	Switch housing - Rover MGTf	3.28
SPC104	Carrier column - Rover MGTf	3.28
SPC105	Switch housing - Rover 45	3.28
SPC106	Carrier column - Rover MGTf	3.28
SPC107	Switch housing - Nissan	3.28
SQB142	Column Switch 163SA - Leyland DAF	3.29
SQB144	Column Switch 164SA - Leyland DAF	3.29
SQB154	Column Switch 264SA Wiper switch - Rover 75	3.29
SQB155	231SA D.I. switch unit - Rover 45	3.29
SQB156	231SA D.I. switch unit - Rover 25	3.29
SQB157	232SA Wiper switch unit - Rover 45	3.29
SQB158	232SA Wiper switch unit - Rover 25	3.29
SQB159	232SA Wiper switch unit - Rover 25	3.29
SQB352	Column switch - Ford	3.30
SQB353	Column switch - Ford	3.30
SQB355	Column switch - Ford	3.30
SQB364	Column switch - Ford	3.30

NEW TO RANGE		
PART NO.	DESCRIPTION	PAGE
SQB365	Column switch - Ford	3.30
SQB366	Column switch - Ford	3.30
SQB367	Column switch - Ford	3.30
SQB385	Column switch - Ford	3.30
SQB386	Column switch - Ford	3.30
SQB404	Column Switch - Nissan	3.30
SQB406	Column Switch - Nissan	3.30
SQB411	227SA Wiper switch - Nissan	3.30
SQB413	227SA Wiper switch - Nissan	3.30
SQB511	Column Switch - Renault	3.31
SQB512	241SA Column switch - Renault	3.31
SQB513	242SA Column switch - Renault	3.31
SQB514	241SA Column switch - Renault	3.31
SQB515	241SA Column switch - Renault	3.31
SQB516	241SA Column switch - Renault	3.31
SQB517	241SA Column switch - Renault	3.31
SQB518	241SA Column switch - Renault	3.31
SQB519	241SA Column switch - Renault	3.31
SQB520	241SA Column switch - Renault	3.31
SQB521	241SA Column switch - Renault	3.31
SQB522	242SA Column switch - Renault	3.31
SQB523	Column switch - Renault	3.31
SQB524	Column switch - Renault	3.31
SQB525	Column switch - Renault	3.31
SQB526	213SA Column switch - Renault	3.31
SQB527	213SA Column switch - Renault	3.31
SQB528	242SA Column switch - Renault	3.31
SQB529	242SA Column switch - Renault	3.31
SQB530	242SA Column switch - Renault	3.31
SQB719	190SA Column Switch - Land Rover	3.32
SQB805	Column Switch - Jaguar	3.32
SQB806	Column Switch - Jaguar	3.32
SQB807	Column Switch - Jaguar	3.32

# Panel Switches



## Panel Switches

- Comprehensive product range including:
  - Rocker switches
  - Rotary switches
  - Rheostats
  - Interchangeable lens inserts
  - and Accessories

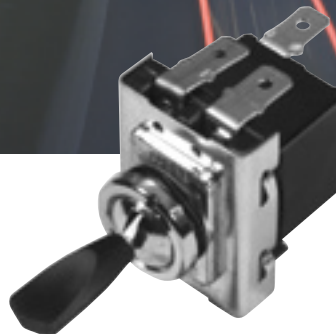

NEW TO RANGE		
PART NO.	DESCRIPTION	PAGE
30794	Panel Switch	3.63
SPB108	Switch accessory	3.63
SPB219	Reverse Light Switch Landrover	3.63
SPB220	Electric Window Switch Landrover	3.63
SPB221	Electric Window Switch Rover MGTf	3.63
SPB222	Switch	3.63
SPB223	Electric Window Switch Single Rover 45	3.63
SPB224	Electric Window Switch Double Rover 45	3.63
SPB225	Electric Window Switch & Isolator Rover 45	3.63
SPB226	Sunroof Switch Rover 45	3.64
SPB227	Sunroof Switch Rover 45	3.64
SPB229	Sunroof Switch Rover 25	3.64
SPB230	Gearbox Snow Mode Switch Rover 45	3.64
SPB231	Electric Window Switch Front Rover 25	3.64
SPB232	Electric Window Switch Front Rover 25	3.64
SPB233	Electric Window Switch Rear Rover 25/45	3.64
SPB234	Hazard Light Switch Rover 45	3.64
SPB235	Seat position Memory Switch Rover 75	3.64
SPB236	Boot Release Switch LH Rover 75	3.64
SPB237	Boot Release Switch RH Rover 75	3.64
SPB238	Master Central Locking Switch Rover 75	3.64
SPB239	Cruise Control Switch Rover 75	3.64
SPB240	Door Lock Switch Rover 75	3.64
SPB241	Hazard Light Switch Rover 75	3.64
SPB242	Rear Sunblind Switch Rover 75	3.64
SPB243	Heated Seat Switch Rover 75	3.64
SPB244	Traction Control Switch Rover 75	3.64
SPB245	Heated Rear Window Switch Rover 75	3.64
SPB247	Electric Window Switch Cluster Rover 25	3.64
SPB248	Electric Mirror Adj Switch Rover 45	3.64
SPB253	Air Con Switch Rover 25	3.64
SPB254	Heated Rear Window Switch Rover 25	3.64

NEW TO RANGE		
PART NO.	DESCRIPTION	PAGE
SPB255	Heated Seat Switch Rover 25	3.64
SPB256	Rear Fog Light Switch Rover 25	3.65
SPB257	Hazard Light Switch Rover MGTf	3.65
SPB258	Electric Window Isolator Switch Rover 25	3.65
SPB259	Panel Dimmer Switch Rover MGTf	3.65
SPB260	Headlamp Adjustment Switch Rover 45	3.65
SPB261	Headlamp Adjustment Switch Rover 45	3.65
SPB262	Headlamp Adjustment Switch Rover 25	3.65
SPB263	Headlamp Adjustment Switch Rover 25	3.65
SPB264	Blank Switch Rover 25,45,75	3.65
SPB265	Trasmission Mode Switch Rover 75	3.65
SPB266	Gear Change Switch Rover MGTf	3.65
SPB310	Rocker Switch	3.65
SPB311	Fan Switch	3.65
SPB314	Electric Window Switch Ford	3.65
SPB315	Electric Window Switch Ford	3.65
SPB316	Electric Window & Boot Switch Ford	3.65
SPB325	Overdrive Switch Renault	3.65
SPB350	Round Rocker Switch On/Off Red LED 12/24V	3.65
SPB351	Toggle Switch On/Off	3.65
SPB352	Toggle Switch On/Off Splashproof	3.65
SPB353	Puch Button Momenatry 12V	3.65
SPB354	Warning Light Red 12V	3.65
SPB355	Warning Light Green 12V	3.65
SPB356	Warning Light Blue 12V	3.65
SPB357	Warning Light Amber 12V	3.66
SPB358	Toggle Switch 3 Way/Change Over	3.66
SPB359	Toggle Switch 3 Way Momentary On/Off/Momentary On	3.66
SPB360	Warning Light Red	3.66
SPB361	Warning Light Green	3.66
SPB362	Warning Light Amber	3.66
SPB363	Warning Light Blue	3.66

NEW TO RANGE		
PART NO.	DESCRIPTION	PAGE
SPB364	Push/Pull Switch Off/Side/Head Light 12V	3.66
SPB365	Toggle Switch Momentary On Long Paddle 12V	3.66
SPB366	Rocker Switch, illuminated 12V	3.66
SPB367	Rocker Switch, illuminated 24V	3.66
SPB368	Rocker Switch, illuminated with lock in on position 12V	3.66
SPB369	Rocker Switch, illuminated with lock in on position 24V	3.66
SPB370	Rocker Switch, illuminated with lock in on & off position 12V	3.66
SPB371	Rocker Switch, illuminated with lock in on & off position 24V	3.66
SPB372	Insert - Windscreen Wiper	3.66
SPB373	Insert - Windscreen Wiper with Wash	3.66
SPB374	Insert - Rear Windscreen Wiper	3.66
SPB375	Insert - Rear Windscreen Wiper with Wash	3.66
SPB376	Insert - Interior Light	3.66
SPB377	Insert - Foglamp	3.66
SPB378	Insert - Worklamp	3.66
SPB379	Insert - Main Lighting	3.66
SPB380	Insert - Rotating Beacon	3.66
SPB381	Insert - Hazard Warning	3.67
SPB382	Insert - Rear Demister	3.67
SPB383	Mounting Frame for 6 Switches	3.67
SPB384	Mounting Frame for 3 Switches	3.67
SPB385	Mounting Frame end piece	3.67
SPB386	Mounting Frame intermediary piece	3.67
SPB387	Mounting Frame for 1 switch	3.67
SPB388	Blank insert	3.67
SPC100	Sunroof Switch Suround	3.67
SQB715	Panel Display	3.67
SQB716	Panel Display	3.67
SQB717	Panel Display	3.67



# Ignition Switches, Relay Switches and Accessories



## Ignition

- Traditional ignition switches
- Suitable for passenger, commercial and industrial applications
- Enhanced technical information available
- S45 / 47SA / 128SA models available
- Keys, steering locks and accessories also available

NEW TO RANGE		
PART NO.	DESCRIPTION	PAGE
SPB501	Switch Accessory	3.80

## Relays

- Comprehensive product range including:
  - Fuelling relays
  - Flasher units
  - Commercial units
  - Classic relays
  - 2ST / 4ST models
  - 26RA / 28RA / 39RA models
  - Solenoids
  - and Accessories

NEW TO RANGE		
PART NO.	DESCRIPTION	PAGE
FDB516	Fuelling Relay - 12v, 40a	3.96
SCB316	Wiper Timer Delay - 12v, 13DA	3.104
SFB191	Flasher Unit - 12v	3.98
SFB200	24V Commercial Flasher	3.98
SFB210	24V Commercial Flasher	3.98
SFB211	24V Commercial Flasher	3.98
SFB212	24V Commercial Flasher	3.98
SRB542	12v, 40a relay	3.104
SRB901	In-line diode	3.104

## Accessories

- Including dip switches, fuse boxes and covers

NEW TO RANGE		
PART NO.	DESCRIPTION	PAGE
34790	Foot operated dip switch	3.107
37564	Fuse Box	3.108
54380114	Fuse Box Cover	3.108
54382781	Fuse Box Cover	3.108





**SUPERCESSIONS**

SFB153 → SFB190	SFB156 → SFB190	SFB162 → SFB190	SFB170 → SFB190	SFB182 → SFB190	60604011 → SQB803

**DELETIONS**

SFB208	SQB800	30373	33737	35478	39630
SFB192	SQB801	30377	33742	35480	39739
SPB121	SQB960	30386	33756	35481	39745
SPB141	SQB984	30404	33816	35598	39746
SPB208	SQB985	30434	33825	35628	39803
SPB209	SQB993	30452	33835	35641	39823
SPB210	SQB994	30593	33847	35698	39824
SPB212	SQB999	30754	33848	35840	39831
SPB213	SRB131	30782	33858	35940	39998
SPB214	SRB201	30792	33859	36546	54033874
SPB215	SRB320	30829	33905	36625	54034025
SPB216	SRB310	30875	33926	36633	54310799
SPB217	SSB100	30876	33963	36743	54310845
SPB218	SSB101	30927	33988	39125	54310957
SPB309	SSB102	30930	33998	39166	54325485
SQB117	SSB104	30952	34239	39279	54329399
SQB121	SSB105	30990	34387	39298	54382845
SQB132	SSB150	30992	34419	39302	60600230
SQB184	SSB151	31120	34680	39454	764505
SQB185	SSB153	316102	34734	39463	78353
SQB218	SSB160	316163	34952	39589	78715
SQB703	SSB170	33727	35351	39629	







# Part Number Index 2



PART NO.	PRODUCT GROUP	PAGE NO.
<b>30000</b>		
30365	Panel Switches	3.52
30563	Column Switches	3.32
30608	Ignition Switches	3.76
30669	Panel Switches	3.63
30713	Panel Switches	3.55
30731	Panel Switches	3.52
30771	Panel Switches	3.55
30794	Panel Switches	3.63
30810	Ignition Switches	3.80
30893	Column Switches	3.32
30924	Panel Switches	3.55
30926	Panel Switches	3.55
30928	Panel Switches	3.56
30935	Panel Switches	3.56
30949	Panel Switches	3.56
31270	Ignition Switches	3.80
31284	Accessories	3.107
31287	Ignition Switches	3.76
31743	Panel Switches	3.59
31780	Panel Switches	3.59
31788	Panel Switches	3.59
31973	Ignition Switches	3.76
33292	Relay Switches	3.98
33714	Panel Switches	3.58
33730	Column Switches	3.32
33803	Column Switches	3.32
33814	Panel Switches	3.63
33820	Ignition Switches	3.76
33838	Ignition Switches	3.77
33852	Panel Switches	3.62
33884	Ignition Switches	3.77
33888	Panel Switches	3.63
33904	Column Switches	3.32
33940	Ignition Switches	3.77
33942	Ignition Switches	3.77
34199	Battery Master Switches	3.7
34245	Panel Switches	3.52
34426	Panel Switches	3.60
34775	Panel Switches	3.61
34790	Accessories	3.107
34889	Panel Switches	3.61
35283	Panel Switches	3.56
35288	Ignition Switches	3.78
35289	Column Switches	3.32
35315	Column Switches	3.32
35323	Column Switches	3.32
35327	Ignition Switches	3.80
35367	Panel Switches	3.57
35414	Column Switches	3.32
35476	Panel Switches	3.63
35497	Column Switches	3.32
35630	Ignition Switches	3.78
35670	Ignition Switches	3.78
35703	Ignition Switches	3.78
35927	Panel Switches	3.60

PART NO.	PRODUCT GROUP	PAGE NO.
36642	Panel Switches	3.57
36649	Panel Switches	3.63
37409	Accessories	3.107
37416	Accessories	3.107
37420	Accessories	3.107
37552	Accessories	3.107
37564	Accessories	3.108
39293	Panel Switches	3.63
39309	Column Switches	3.32
39314	Panel Switches	3.53
39315	Panel Switches	3.53
39364	Panel Switches	3.63
39413	Column Switches	3.32
39415	Column Switches	3.32
39427	Ignition Switches	3.79
39710	Panel Switches	3.53
39719	Column Switches	3.32
39736	Panel Switches	3.53
39737	Panel Switches	3.54
39738	Panel Switches	3.63
39748	Panel Switches	3.54
39798	Ignition Switches	3.79
39858	Column Switches	3.32
39914	Panel Switches	3.54
39915	Panel Switches	3.54
39976	Panel Switches	3.63
39980	Panel Switches	3.57
<b>70000</b>		
78405	Panel Switches	3.58
<b>50000000</b>		
54033527	Ignition Switches	3.79
54033632	Panel Switches	3.63
54033998	Column Switches	3.32
54034069	Panel Switches	3.63
54038068	Accessories	3.107
54316695	Ignition Switches	3.80
54316731	Ignition Switches	3.80
54316732	Ignition Switches	3.80
54324157	Ignition Switches	3.80
54329399	Panel Switches	3.63
54331311	Panel Switches	3.58
54340037	Panel Switches	3.58
54363860	Accessories	3.108
54380114	Accessories	3.108
54382781	Accessories	3.108
<b>FDB</b>		
FDB501	Relay Switches	3.95
FDB502	Relay Switches	3.95
FDB503	Relay Switches	3.95
FDB504	Relay Switches	3.95
FDB505	Relay Switches	3.95
FDB506	Relay Switches	3.95
FDB507	Relay Switches	3.95
FDB508	Relay Switches	3.95
FDB509	Relay Switches	3.95
FDB510	Relay Switches	3.95



PART NO.	PRODUCT GROUP	PAGE NO.
<b>FDB CONTINUED</b>		
FDB511	Relay Switches	3.96
FDB516	Relay Switches	3.96
<b>LBM</b>		
LBM12100	Inverters	3.3
LBM12150	Inverters	3.3
LBM12300	Inverters	3.3
LBM12500	Inverters	3.3
LBM121000	Inverters	3.3
LBM122000	Inverters	3.3
LBM24500	Inverters	3.4
LBM241000	Inverters	3.4
LBM242000	Inverters	3.4
LBMRC	Inverters	3.4
LBMRC10	Inverters	3.4
<b>SCB</b>		
SCB312	Relay Switches	3.104
SCB314	Relay Switches	3.104
SCB316	Relay Switches	3.104
SCB318	Relay Switches	3.104
SCB400	Relay Switches	3.104
<b>SFB</b>		
SFB100	Relay Switches	3.96
SFB105	Relay Switches	3.96
SFB106	Relay Switches	3.96
SFB108	Relay Switches	3.96
SFB114	Relay Switches	3.96
SFB130	Relay Switches	3.96
SFB153	Relay Switches	3.96
SFB156	Relay Switches	3.96
SFB161	Relay Switches	3.97
SFB162	Relay Switches	3.97
SFB163	Relay Switches	3.97
SFB164	Relay Switches	3.97
SFB165	Relay Switches	3.97
SFB166	Relay Switches	3.97
SFB167	Relay Switches	3.97
SFB170	Relay Switches	3.97
SFB171	Relay Switches	3.97
SFB182	Relay Switches	3.97
SFB190	Relay Switches	3.98
SFB191	Relay Switches	3.98
SFB200	Relay Switches	3.98
SFB210	Relay Switches	3.98
SFB211	Relay Switches	3.98
SFB212	Relay Switches	3.98
SFB300	Panel Switches	3.63
<b>SPB</b>		
SPB104	Panel Switches	3.62
SPB105	Panel Switches	3.62
SPB106	Panel Switches	3.62
SPB107	Panel Switches	3.63
SPB108	Panel Switches	3.63
SPB120	Panel Switches	3.58
SPB140	Panel Switches	3.63
SPB160	Panel Switches	3.62

PART NO.	PRODUCT GROUP	PAGE NO.
SPB200	Panel Switches	3.60
SPB203	Panel Switches	3.61
SPB204	Panel Switches	3.61
SPB219	Panel Switches	3.63
SPB220	Panel Switches	3.63
SPB221	Panel Switches	3.63
SPB222	Panel Switches	3.63
SPB223	Panel Switches	3.63
SPB224	Panel Switches	3.63
SPB225	Panel Switches	3.63
SPB226	Panel Switches	3.64
SPB227	Panel Switches	3.64
SPB228	Column Switches	3.28
SPB229	Panel Switches	3.64
SPB230	Panel Switches	3.64
SPB231	Panel Switches	3.64
SPB232	Panel Switches	3.64
SPB233	Panel Switches	3.64
SPB234	Panel Switches	3.64
SPB235	Panel Switches	3.64
SPB236	Panel Switches	3.64
SPB237	Panel Switches	3.64
SPB238	Panel Switches	3.64
SPB239	Panel Switches	3.64
SPB240	Panel Switches	3.64
SPB241	Panel Switches	3.64
SPB242	Panel Switches	3.64
SPB243	Panel Switches	3.64
SPB244	Panel Switches	3.64
SPB245	Panel Switches	3.64
SPB247	Panel Switches	3.64
SPB248	Panel Switches	3.64
SPB253	Panel Switches	3.64
SPB254	Panel Switches	3.64
SPB255	Panel Switches	3.64
SPB256	Panel Switches	3.65
SPB257	Panel Switches	3.65
SPB258	Panel Switches	3.65
SPB259	Panel Switches	3.65
SPB260	Panel Switches	3.65
SPB261	Panel Switches	3.65
SPB262	Panel Switches	3.65
SPB263	Panel Switches	3.65
SPB264	Panel Switches	3.65
SPB265	Panel Switches	3.65
SPB266	Panel Switches	3.65
SPB310	Panel Switches	3.65
SPB311	Panel Switches	3.65
SPB314	Panel Switches	3.65
SPB315	Panel Switches	3.65
SPB316	Panel Switches	3.65
SPB325	Panel Switches	3.65
SPB326	Column Switches	3.28
SPB327	Column Switches	3.28
SPB328	Column Switches	3.28
SPB329	Column Switches	3.28



PART NO.	PRODUCT GROUP	PAGE NO.
<b>SPB CONTINUED</b>		
SPB330	Column Switches	3.28
SPB331	Column Switches	3.28
SPB332	Column Switches	3.28
SPB333	Column Switches	3.28
SPB334	Column Switches	3.28
SPB335	Column Switches	3.28
SPB336	Column Switches	3.28
SPB337	Column Switches	3.28
SPB350	Panel Switches	3.65
SPB351	Panel Switches	3.65
SPB352	Panel Switches	3.65
SPB353	Panel Switches	3.65
SPB354	Panel Switches	3.65
SPB355	Panel Switches	3.65
SPB356	Panel Switches	3.65
SPB357	Panel Switches	3.66
SPB358	Panel Switches	3.66
SPB359	Panel Switches	3.66
SPB360	Panel Switches	3.66
SPB361	Panel Switches	3.66
SPB362	Panel Switches	3.66
SPB363	Panel Switches	3.66
SPB364	Panel Switches	3.66
SPB365	Panel Switches	3.66
SPB366	Panel Switches	3.66
SPB367	Panel Switches	3.66
SPB368	Panel Switches	3.66
SPB369	Panel Switches	3.66
SPB370	Panel Switches	3.66
SPB371	Panel Switches	3.66
SPB372	Panel Switches	3.66
SPB373	Panel Switches	3.66
SPB374	Panel Switches	3.66
SPB375	Panel Switches	3.66
SPB376	Panel Switches	3.66
SPB377	Panel Switches	3.66
SPB378	Panel Switches	3.66
SPB379	Panel Switches	3.66
SPB380	Panel Switches	3.66
SPB381	Panel Switches	3.67
SPB382	Panel Switches	3.67
SPB383	Panel Switches	3.67
SPB384	Panel Switches	3.67
SPB385	Panel Switches	3.67
SPB386	Panel Switches	3.67
SPB387	Panel Switches	3.67
SPB388	Panel Switches	3.67
SPB501	Ignition Switches	3.80
<b>SPC</b>		
SPC100	Panel Switches	3.67
SPC101	Column Switches	3.28
SPC102	Column Switches	3.28
SPC103	Column Switches	3.28
SPC104	Column Switches	3.28
SPC105	Column Switches	3.28

PART NO.	PRODUCT GROUP	PAGE NO.
SPC106	Column Switches	3.28
SPC107	Column Switches	3.28
<b>SQB</b>		
SQB106	Column Switches	3.28
SQB108	Column Switches	3.28
SQB109	Column Switches	3.28
SQB113	Column Switches	3.28
SQB114	Column Switches	3.28
SQB115	Column Switches	3.28
SQB116	Column Switches	3.28
SQB118	Column Switches	3.28
SQB119	Column Switches	3.28
SQB122	Column Switches	3.28
SQB126	Column Switches	3.29
SQB127	Column Switches	3.29
SQB128	Column Switches	3.29
SQB129	Column Switches	3.29
SQB130	Column Switches	3.29
SQB134	Column Switches	3.29
SQB135	Column Switches	3.29
SQB136	Column Switches	3.29
SQB140	Column Switches	3.29
SQB141	Column Switches	3.29
SQB142	Column Switches	3.29
SQB143	Column Switches	3.29
SQB144	Column Switches	3.29
SQB154	Column Switches	3.29
SQB155	Column Switches	3.29
SQB156	Column Switches	3.29
SQB157	Column Switches	3.29
SQB158	Column Switches	3.29
SQB159	Column Switches	3.29
SQB160	Column Switches	3.29
SQB161	Column Switches	3.29
SQB166	Column Switches	3.29
SQB167	Column Switches	3.29
SQB168	Column Switches	3.29
SQB175	Column Switches	3.29
SQB176	Column Switches	3.29
SQB183	Column Switches	3.29
SQB187	Column Switches	3.29
SQB188	Column Switches	3.29
SQB189	Column Switches	3.29
SQB190	Column Switches	3.30
SQB191	Column Switches	3.30
SQB194	Column Switches	3.30
SQB195	Column Switches	3.30
SQB197	Column Switches	3.30
SQB198	Column Switches	3.30
SQB222	Column Switches	3.30
SQB223	Column Switches	3.30
SQB224	Column Switches	3.30
SQB225	Column Switches	3.30
SQB352	Column Switches	3.30
SQB353	Column Switches	3.30
SQB355	Column Switches	3.30



PART NO.	PRODUCT GROUP	PAGE NO.
<b>SQB CONTINUED</b>		
SQB364	Column Switches	3.30
SQB365	Column Switches	3.30
SQB366	Column Switches	3.30
SQB367	Column Switches	3.30
SQB385	Column Switches	3.30
SQB386	Column Switches	3.30
SQB404	Column Switches	3.30
SQB406	Column Switches	3.30
SQB407	Column Switches	3.30
SQB409	Column Switches	3.30
SQB411	Column Switches	3.30
SQB413	Column Switches	3.30
SQB417	Column Switches	3.30
SQB420	Column Switches	3.30
SQB421	Column Switches	3.30
SQB423	Column Switches	3.30
SQB425	Column Switches	3.30
SQB426	Column Switches	3.31
SQB427	Column Switches	3.31
SQB428	Column Switches	3.31
SQB429	Column Switches	3.31
SQB500	Column Switches	3.31
SQB511	Column Switches	3.31
SQB512	Column Switches	3.31
SQB513	Column Switches	3.31
SQB514	Column Switches	3.31
SQB515	Column Switches	3.31
SQB516	Column Switches	3.31
SQB517	Column Switches	3.31
SQB518	Column Switches	3.31
SQB519	Column Switches	3.31
SQB520	Column Switches	3.31
SQB521	Column Switches	3.31
SQB522	Column Switches	3.31
SQB523	Column Switches	3.31
SQB524	Column Switches	3.31
SQB525	Column Switches	3.31
SQB526	Column Switches	3.31
SQB527	Column Switches	3.31
SQB528	Column Switches	3.31
SQB529	Column Switches	3.31
SQB530	Column Switches	3.31
SQB701	Column Switches	3.31
SQB702	Column Switches	3.31
SQB704	Panel Switches	3.67
SQB705	Panel Switches	3.67
SQB706	Panel Switches	3.67
SQB707	Column Switches	3.31
SQB709	Column Switches	3.31
SQB710	Panel Switches	3.67
SQB711	Panel Switches	3.67
SQB712	Panel Switches	3.67
SQB713	Panel Switches	3.67
SQB714	Panel Switches	3.67
SQB715	Panel Switches	3.67

PART NO.	PRODUCT GROUP	PAGE NO.
SQB716	Panel Switches	3.67
SQB717	Panel Switches	3.67
SQB718	Column Switches	3.31
SQB719	Column Switches	3.32
SQB803	Column Switches	3.32
SQB805	Column Switches	3.32
SQB806	Column Switches	3.32
SQB807	Column Switches	3.32
SQB940	Column Switches	3.32
SQB964	Column Switches	3.32
SQB965	Column Switches	3.32
SQB967	Panel Switches	3.57
SQB968	Column Switches	3.32
SQB986	Column Switches	3.32
SQB991	Column Switches	3.32
SQB992	Column Switches	3.32
SQB995	Column Switches	3.32
SQB996	Column Switches	3.32
<b>SRB</b>		
SRB111	Relay Switches	3.98
SRB113	Relay Switches	3.98
SRB143	Relay Switches	3.99
SRB146	Relay Switches	3.99
SRB220	Relay Switches	3.99
SRB301	Relay Switches	3.99
SRB303	Relay Switches	3.99
SRB311	Panel Switches	3.67
SRB312	Panel Switches	3.67
SRB319	Relay Switches	3.99
SRB321	Relay Switches	3.99
SRB325	Relay Switches	3.99
SRB333	Relay Switches	3.99
SRB335	Relay Switches	3.100
SRB341	Relay Switches	3.100
SRB346	Relay Switches	3.100
SRB351	Relay Switches	3.100
SRB400	Relay Switches	3.100
SRB402	Relay Switches	3.100
SRB411	Relay Switches	3.100
SRB420	Relay Switches	3.100
SRB500	Relay Switches	3.100
SRB501	Relay Switches	3.101
SRB502	Relay Switches	3.101
SRB506	Relay Switches	3.101
SRB507	Relay Switches	3.101
SRB510	Relay Switches	3.101
SRB511	Relay Switches	3.101
SRB520	Relay Switches	3.101
SRB521	Relay Switches	3.101
SRB522	Relay Switches	3.101
SRB523	Relay Switches	3.101
SRB525	Relay Switches	3.102
SRB526	Relay Switches	3.102
SRB527	Relay Switches	3.102
SRB528	Relay Switches	3.102
SRB529	Relay Switches	3.102



PART NO.	PRODUCT GROUP	PAGE NO.
<b>SRB CONTINUED</b>		
SRB530	Relay Switches	3.102
SRB531	Relay Switches	3.102
SRB532	Relay Switches	3.102
SRB533	Relay Switches	3.102
SRB535	Relay Switches	3.102
SRB537	Relay Switches	3.103
SRB538	Relay Switches	3.103
SRB539	Relay Switches	3.103
SRB540	Relay Switches	3.103
SRB541	Relay Switches	3.103
SRB542	Relay Switches	3.104
SRB600	Relay Switches	3.103
SRB601	Relay Switches	3.103
SRB630	Relay Switches	3.103
SRB631	Relay Switches	3.104
SRB632	Relay Switches	3.104
SRB901	Relay Switches	3.104
<b>SSB</b>		
SSB103	Battery Master Switches	3.7
SSB106	Battery Master Switches	3.7
SSB110	Battery Master Switches	3.7
SSB111	Battery Master Switches	3.8
SSB112	Battery Master Switches	3.8
SSB113	Battery Master Switches	3.8
SSB114	Battery Master Switches	3.8
SSB200	Battery Master Switches	3.8
SSB201	Battery Master Switches	3.9
SSB202	Battery Master Switches	3.9
SSB203	Battery Master Switches	3.9
SSB204	Battery Master Switches	3.9
SSB300	Ignition Switches	3.80
SSB301	Ignition Switches	3.80
SSB302	Ignition Switches	3.80
SSB303	Ignition Switches	3.80
SSB304	Ignition Switches	3.80
SSB305	Ignition Switches	3.80

PART NO.	PRODUCT GROUP	PAGE NO.





# 3

## Inverters

Application List

Page 3.2

Product Specification

Page 3.3

# Inverters



		MODIFIED WAVE INVERTERS								
		12 VOLT						24 VOLT		
APPLIANCE	WATTAGE	LBM12100	LBM12150	LBM12300	LBM12500	LBM121000	LBM122000	LBM24500	LBM241000	LBM242000
<b>HOUSEHOLD</b>										
Charger - Mobile Phone	5-10	✓	✓	✓	✓	✓	✓	✓	✓	✓
Charger - Digital Camera	4-19	✓	✓	✓	✓	✓	✓	✓	✓	✓
Portable Stereo System	10-40	✓	✓	✓	✓	✓	✓	✓	✓	✓
Laptop Computer	60-95	✓	✓	✓	✓	✓	✓	✓	✓	✓
Video Game Console	39-100	✓	✓	✓	✓	✓	✓	✓	✓	✓
Portable DVD Player	75-100	✓	✓	✓	✓	✓	✓	✓	✓	✓
TV 19" Screen	100-160		✓	✓	✓	✓	✓	✓	✓	✓
CD/Radio Player	200-400			✓	✓	✓	✓	✓	✓	✓
Printer	100-300			✓	✓	✓	✓	✓	✓	✓
Fax Machine	200-400			✓	✓	✓	✓	✓	✓	✓
PC with Monitor	200-400			✓	✓	✓	✓	✓	✓	✓
500w Halogen Floodlight	500				✓	✓	✓	✓	✓	✓
Camping Kettle	750-1000					✓	✓		✓	✓
Toaster	800-1500						✓			✓
Hair Dryer	1000-2000						✓			✓
Oil Radiator	1800-2500									
Kettle	2000-2500									
Fan Heater	2000-3000									
<b>COMMERCIAL</b>										
Orbital Sander	250-400				✓	✓	✓	✓	✓	✓
Jigsaw - DIY	300-500				✓	✓	✓	✓	✓	✓
Lawn Mower - 12" cylindrical	300-500				✓	✓	✓	✓	✓	✓
Strimmer	300-500				✓	✓	✓	✓	✓	✓
Belt Sander	300-700				✓	✓	✓	✓	✓	✓
Hedge Trimmer	400-500				✓	✓	✓	✓	✓	✓
Jigsaw	500-700					✓	✓		✓	✓
Rotary Hammer Drill	700-1000					✓	✓		✓	✓
Belt Sander	1000-1300						✓			✓
Hammer Drill	1000-1300						✓			✓
Lawn Mower - 12" hover	1100-1300						✓			✓
Circular Saw	1400-1800									
Hot air gun	1800-2200									
Pressure Washer	2500-3000									



PART NUMBER	PICTURE	INPUT VOLTAGE	OUTPUT VOLTAGE	HZ	CONTINUOUS (30MINS) WATTS	PEAK WATTS	EFFICIENCY	DIMENSIONS W X H X D (MM)	WEIGHT (KGS)	MODIFIED OR PURE SINE WAVE
<b>MODIFIED SINE WAVE - 12 VOLT</b>										
LBM12100		10-15	210 - 230	50	100	200	90%	74 x 45 x 135	0.16	Modified
LBM12150		10-15	210 - 230	50	150	300	90%	103 x 65 x 150	0.65	Modified
LBM12300		10-15	210 - 230	50	300	600	90%	103 x 65 x 205	0.8	Modified
LBM12500		10-15	210 - 230	50	500	1000	90%	103 x 65 x 240	1.2	Modified
LBM121000	<p>WHILE STOCKS LAST</p>	10-15	210 - 230	50	1000	1600	87%	210 x 77 x 300	4	Modified
LBM122000		10-15	210 - 230	50	2000	3200	90%	210 x 77 x 410	6	Modified



PART NUMBER	PICTURE	INPUT VOLTAGE	OUTPUT VOLTAGE	HZ	CONTINUOUS (30MINS) WATTS	PEAK WATTS	EFFICIENCY	DIMENSIONS W X H X D (MM)	WEIGHT (KGS)	MODIFIED OR PURE SINE WAVE
<b>MODIFIED SINE WAVE - 24 VOLT</b>										
LBM24500		20-30	210 - 230	50	500	1000	90%	103 x 65 x 240	1.2	Modified
LBM241000		22-30	210 - 230	50	1000	1600	90%	210 x 77 x 300	4	Modified
LBM242000		22-30	210 - 230	50	2000	3200	90%	210 x 77 x 410	6	Modified
<b>ACCESSORIES</b>										
LBMRC	<p>Remote control Unit for 1000w and 2000w</p> 									
LBMRC10	<p>Remote control Unit Extension cable</p> 									





## Battery Master Switches

Application List

Page 3.6

Product Specification

Page 3.7







# Battery Master Switches 3

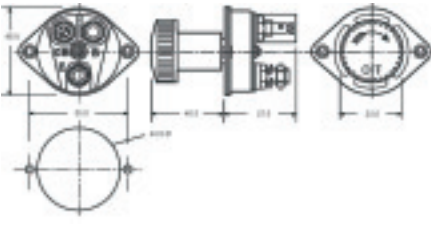
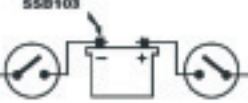

MODEL	TYPE	FUNCTION	ENGINE INFO	CC	YEAR	PART NO.
<b>ASTON MARTIN</b>						
Lagonda (5.3)	ST330 / ST350	Battery Master Switch	V8	5340	1976-85	<b>SSB103</b>
Lagonda (5.3)	ST360	Battery Master Switch	V8	5340	1980-85	<b>SSB106</b>
Lagonda (5.3i)	ST360	Battery Master Switch	V8	5340	1985-90	<b>SSB106</b>
Lagonda (5.3i)	ST330 / ST350	Battery Master Switch	V8	5340	1985-90	<b>SSB103</b>
V8	ST360	Battery Master Switch	V8	5340	1985-87	<b>SSB106</b>
V8 Volante	ST360	Battery Master Switch	V8	5340	1985-89	<b>SSB106</b>
Vantage (V8)	ST360	Battery Master Switch	V8	5340	1985-89	<b>SSB106</b>
Vantage (V8) Volante	ST360	Battery Master Switch	V8	5340	1986-89	<b>SSB106</b>
<b>LAND ROVER</b>						
Land Rover Defender 110 2.5	219SA	Battery Master Switch	4 Cyl	2495	1990-92	<b>SSB110</b>
Land Rover Defender 110 2.5 D	219SA	Battery Master Switch	4 Cyl	2495	1990-93	<b>SSB110</b>
Land Rover Defender 110 2.5 Tdi (300)	219SA	Battery Master Switch	4 Cyl	2495	1994-98	<b>SSB110</b>
Land Rover Defender 110 V8	219SA	Battery Master Switch		3528	1990-95	<b>SSB110</b>
Land Rover Defender 130 2.5 Tdi	219SA	Battery Master Switch	4 Cyl	2495	1990-94	<b>SSB110</b>
Land Rover Defender 130 V8	219SA	Battery Master Switch		3528	1990-95	<b>SSB110</b>
Land Rover Defender 90 2.5, 90 2.5 D, Tdi	219SA	Battery Master Switch	4 Cyl	2495	1990-94	<b>SSB110</b>
Land Rover Defender 90 V8	219SA	Battery Master Switch	V8	3528	1990-95	<b>SSB110</b>
<b>ROLLS-ROYCE (BENTLEY)</b>						
Mulsanne	ST360	Battery Master Switch	V8 OHV	6750	1986-92	<b>SSB106</b>
Mulsanne	ST360	Battery Master Switch	V8 OHV	6750	1980-86	<b>SSB106</b>
Silver Spirit	ST360	Battery Master Switch	V8 OHV	6750	1980-86	<b>SSB106</b>
Silver Spirit	ST360	Battery Master Switch	V8 OHV	6750	1986-89	<b>SSB106</b>
Silver Spirit II	ST360	Battery Master Switch	V8 OHV	6750	1989-92	<b>SSB106</b>
Silver Spirit III	ST360	Battery Master Switch	V8 OHV	6750	1992-96	<b>SSB106</b>
Silver Spur	ST360	Battery Master Switch	V8 OHV	6750	1986-89	<b>SSB106</b>
Silver Spur	ST360	Battery Master Switch	V8 OHV	6750	1980-86	<b>SSB106</b>
Silver Spur II	ST360	Battery Master Switch	V8 OHV	6750	1989-92	<b>SSB106</b>
Silver Spur III	ST360	Battery Master Switch	V8 OHV	6750	1992 >>	<b>SSB106</b>

BATTERY MASTER SWITCHES – APPLICATION LIST

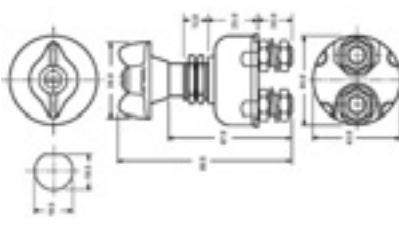

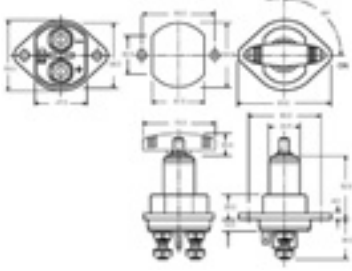





PART NO.	PRODUCT	TERMINATION	COMMENT																					
34199	Battery master handle 																							
SSB103	ST330 / ST350 	 <table border="1"> <thead> <tr> <th>Maximum current ratings</th> <th colspan="2">SSB103</th> </tr> </thead> <tbody> <tr> <td>Voltage</td> <td>12 V</td> <td>24 V</td> </tr> <tr> <td>Intermittent loads-5 secs max</td> <td>800 A</td> <td>250 A</td> </tr> <tr> <td>Continuous loads</td> <td>150 A</td> <td>75 A</td> </tr> </tbody> </table> <b>SSB103 - ST330 ~ (1)</b> Panel mounted negative terminal Ensure switch is connected to correct battery terminal polarity 	Maximum current ratings	SSB103		Voltage	12 V	24 V	Intermittent loads-5 secs max	800 A	250 A	Continuous loads	150 A	75 A	Knob operated rotary battery isolation switch. Panel or battery mounted. Suitable for cars, light commercial vehicles and light industrial applications. 12V or 24V systems. Incorporates a small third terminal for connections to the low tension (LT) circuit, which prevents the vehicle from being started by towing or pushing, when the switch is in the 'OFF' position. Electrical connections are stud terminals.									
Maximum current ratings	SSB103																							
Voltage	12 V	24 V																						
Intermittent loads-5 secs max	800 A	250 A																						
Continuous loads	150 A	75 A																						
SSB106	ST360 	 <table border="1"> <thead> <tr> <th>Maximum current ratings</th> <th colspan="2">SSB106</th> </tr> </thead> <tbody> <tr> <td>Voltage</td> <td>12 V</td> <td>24 V</td> </tr> <tr> <td>Intermittent loads</td> <td>1500 A</td> <td>500 A</td> </tr> <tr> <td>Continuous loads</td> <td>150 A</td> <td>100 A</td> </tr> </tbody> </table> Circuit: 1 — 2 'OFF' — 'ON' —▲▲	Maximum current ratings	SSB106		Voltage	12 V	24 V	Intermittent loads	1500 A	500 A	Continuous loads	150 A	100 A	Panel mounted rotary 'ON-OFF' battery isolator switch. Suitable for cars, light commercial vehicles and industrial applications. 12V or 24V systems. Electrical connections are stud terminals.									
Maximum current ratings	SSB106																							
Voltage	12 V	24 V																						
Intermittent loads	1500 A	500 A																						
Continuous loads	150 A	100 A																						
SSB110	219SA 	 <table border="1"> <thead> <tr> <th>Maximum current ratings</th> <th colspan="2">SSB110</th> </tr> </thead> <tbody> <tr> <td>Voltage</td> <td>12 V</td> <td>24 V</td> </tr> <tr> <td>Intermittent loads-5 Secs</td> <td>1500 A *</td> <td>750 A</td> </tr> <tr> <td>Intermittent loads-60 Secs</td> <td>600 A *</td> <td>300 A</td> </tr> <tr> <td>Continuous loads</td> <td>150 A *</td> <td>150 A</td> </tr> <tr> <td>Locking Handle (red)</td> <td colspan="2">34199</td> </tr> <tr> <td>Order separately</td> <td colspan="2"></td> </tr> </tbody> </table> Note: For 1500A and 600A applications, cables fitted to the main terminals should be 12/16mm <sup>2</sup> or min.	Maximum current ratings	SSB110		Voltage	12 V	24 V	Intermittent loads-5 Secs	1500 A *	750 A	Intermittent loads-60 Secs	600 A *	300 A	Continuous loads	150 A *	150 A	Locking Handle (red)	34199		Order separately			Rotary, battery isolator switch designed for panel or bulkhead mounting. Incorporates a 100 Ohm tachograph barrier resistor. Suitable for 12V or 24V passenger, commercial vehicle and marine applications.
Maximum current ratings	SSB110																							
Voltage	12 V	24 V																						
Intermittent loads-5 Secs	1500 A *	750 A																						
Intermittent loads-60 Secs	600 A *	300 A																						
Continuous loads	150 A *	150 A																						
Locking Handle (red)	34199																							
Order separately																								

BATTERY MASTER SWITCHES – PRODUCT SPECIFICATION

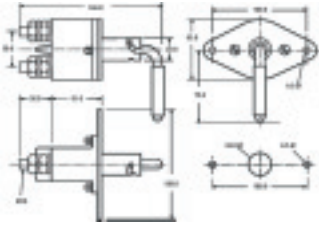

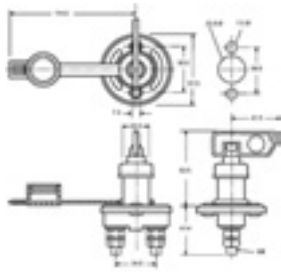



The power to SWITCH

BATTERY MASTER SWITCHES – PRODUCT SPECIFICATION

PART NO.	PRODUCT	TERMINATION	COMMENT												
SSB111	219SA 	 Circuit 1 ————— 2 'OFF' ————— 'ON' —▲————▲—	<p>A heavy duty, rotary operated battery isolation switch, capable of switching up to 250 A continuous load. Incorporates a removable key for added security. Suitable for 12V or 24V passenger and commercial vehicles.</p> <table border="1"> <thead> <tr> <th>Maximum current ratings</th> <th colspan="2">SSB111</th> </tr> </thead> <tbody> <tr> <td>Voltage</td> <td></td> <td>12/24 V</td> </tr> <tr> <td>Intermittent loads</td> <td>5 Secs</td> <td>2500 A</td> </tr> <tr> <td>Continuous loads</td> <td></td> <td>250 A</td> </tr> </tbody> </table>	Maximum current ratings	SSB111		Voltage		12/24 V	Intermittent loads	5 Secs	2500 A	Continuous loads		250 A
Maximum current ratings	SSB111														
Voltage		12/24 V													
Intermittent loads	5 Secs	2500 A													
Continuous loads		250 A													
SSB112	ST360 	 Circuit 1 ————— 2 'OFF' ————— 'ON' —▲————▲—	<p>Rotary, battery isolator switch designed for panel or bulkhead mounting. Incorporates removable 'Flag Key' for added security and is supplied with a splash cap. Suitable for 12V or 24V passenger, commercial vehicle and marine applications. A replacement key can be ordered (part number SSB113).</p> <table border="1"> <thead> <tr> <th>Maximum current ratings</th> <th colspan="2">SSB112</th> </tr> </thead> <tbody> <tr> <td>Voltage</td> <td></td> <td>12/24 V</td> </tr> <tr> <td>Intermittent loads</td> <td>10 Secs</td> <td>500 A</td> </tr> <tr> <td>Continuous loads</td> <td></td> <td>100 A</td> </tr> </tbody> </table>	Maximum current ratings	SSB112		Voltage		12/24 V	Intermittent loads	10 Secs	500 A	Continuous loads		100 A
Maximum current ratings	SSB112														
Voltage		12/24 V													
Intermittent loads	10 Secs	500 A													
Continuous loads		100 A													
SSB113	Battery master flag key 														
SSB114	Battery master handle 														
SSB200	Battery switch 250amp with fixed 'T' key 														



PART NO.	PRODUCT	TERMINATION	COMMENT
SSB201	Battery switch 250amp emergency stop 		
SSB202	Battery switch 250amp with removable key 		
SSB203	Battery switch 250amp change over with fixed key 		
SSB204	BMS Isolator switch splash proof 100a 24v 		

BATTERY MASTER SWITCHES – PRODUCT SPECIFICATION



A large, empty rectangular box with a thin black border, intended for handwritten notes.





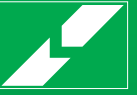

## Column Switches

Application List

Page 3.12

Product Specification

Page 3.28

# Column Switches 3



MODEL	YEAR	DESCRIPTION	ADDITIONAL INFORMATION	ICONS	PART NO.
<b>Key</b> 1-Directional Indicator                         5-Flash                         9-Washer                         13-Rear Wipe/Wash                         17-Front Fog 2-Main Beam                         6-Hazard Warning                         10-Intermittent Wipe                         14-Rear Fog 3-Dipped Lights                         7-Horn                         11-Variable Intermittent Wipe                         15-Trip Computer 4-Side Lights                         8-Wiper                         12-Flick Wipe                         16-Combined Hazard/Indicator					
<b>AC</b>					
3000 ME	1979-85	Indicator, Horn, Lights, Flash, Main Beam & Dip	Ford V6		SQB119
<b>BEDFORD</b>					
M1120 Special Appliance 4x4	1975-87	Main Beam & Dip, Front Wash Wipe			SQB222
M1120 Special Appliance 4x4	1975-87	Indicator, Horn, Flash & Dip			SQB223
SB, SP, TJ, TK, TL, TM, VAL, VAM, VAS, YMT, YRQ, YRT	1975-87	Indicator, Horn, Flash & Dip			SQB223
SB, SP, TJ, TK, TL, TM, VAL, VAM, VAS, YMT, YRQ, YRT	1976-87	Main Beam & Dip, Front Wash Wipe			SQB222
<b>DENNIS EAGLE</b>					
Bulkmaster 50, 70 Municipal	1979-83	Main Beam & Dip, Front Wash Wipe			SQB222
Bulkmaster 50, 70 Municipal	1979-83	Indicator, Horn, Flash & Dip			SQB223
<b>DENNIS SPECIALIST VEHICLES</b>					
Delta 16	1979>>	Main Beam & Dip, Front Wash Wipe			SQB222
Delta 16	1979>>	Indicator, Horn, Flash & Dip			SQB223
Fire Engine: RS Range	1979>>	Main Beam & Dip, Front Wash Wipe			SQB222
Fire Engine: RS Range	1979>>	Indicator, Horn, Flash & Dip			SQB223
<b>ERF</b>					
84 PF, PFS, PS Fire Appliance	1973-79	Column Lock Switch			39413
84 PF, PFS, PS Fire Appliance	1973-79	Column Lock Switch			39413
84 PF, PFS, PS, RFS, RS, 86 PS, RS Fire Appliance, B34, B35	1969-80	Main Beam & Dip, Front Wash Wipe			SQB222
84 PF, PFS, PS, RFS, RS, 86 PS, RS Fire Appliance, B34, B35	1974-80	Indicator, Horn, Flash & Dip			SQB223
84 RFS, RS Fire Appliance	1973-79	Column Lock Switch			39413
84 RFS, RS Fire Appliance	1973-79	Column Lock Switch			39413
86 PS, RS Fire Appliance	1973-79	Column Lock Switch			39413
86 PS, RS Fire Appliance	1973-79	Column Lock Switch			39413
<b>FODEN</b>					
S10 G2010, S21 FG, S80, S83, S90, S95	1976-82	Indicator, Horn, Lights, Flash, Main Beam & Dip			SQB986
S10 G2010, S21 FG, S80, S83, S90, S95	1976-82	Main Beam & Dip, Front Wash Wipe			SQB991
<b>FORD</b>					
Escort MK3	1981-86	Indicator, Horn, Lights, Flash, Main Beam & Dip			SQB429
Escort MK5	07/90-10/98	Indicator, Lights, Flash, Main Beam & Dip, Hazard, Front & Rear Wash Wipe	Without Variable Speed Adjustment		SQB352
Escort MK5	07/90-10/98	Indicator, Lights, Flash, Main Beam & Dip, Hazard, Front Wash Wipe	Without Variable Speed Adjustment		SQB353
Escort MK5	07/90-10/98	Indicator, Lights, Flash, Main Beam & Dip, Hazard, Front & Rear Wash Wipe	With Variable Speed Adjustment		SQB355

COLUMN SWITCHES – APPLICATION LIST



MODEL	YEAR	DESCRIPTION	ADDITIONAL INFORMATION	ICONS	PART NO.
<b>FORD CONTINUED</b>					
Escort MK6	07/90-10/98	Indicator, Lights, Flash, Main Beam & Dip, Hazard, Front & Rear Wash Wipe	Without Variable Speed Adjustment		SQB352
Escort MK6	07/90-10/98	Indicator, Lights, Flash, Main Beam & Dip, Hazard, Front Wash Wipe	Without Variable Speed Adjustment		SQB353
Escort MK6	07/90-10/98	Indicator, Lights, Flash, Main Beam & Dip, Hazard, Front & Rear Wash Wipe	With Variable Speed Adjustment		SQB355
Escort MK7	07/90-10/98	Indicator, Lights, Flash, Main Beam & Dip, Hazard, Front & Rear Wash Wipe	Without Variable Speed Adjustment		SQB352
Escort MK7	07/90-10/98	Indicator, Lights, Flash, Main Beam & Dip, Hazard, Front Wash Wipe	Without Variable Speed Adjustment		SQB353
Escort MK7	07/90-10/98	Indicator, Lights, Flash, Main Beam & Dip, Hazard, Front & Rear Wash Wipe	With Variable Speed Adjustment		SQB355
Fiesta	1995-98	Indicator, Lights, Flash, Main Beam & Dip, Hazard, Front & Rear Wash Wipe	Without Variable Speed Adjustment		SQB365
Fiesta	1998-01	Indicator, Lights, Flash, Main Beam & Dip, Hazard, Front & Rear Wash Wipe			SQB367
Focus	1998-05	Rear Wash Wipe			SQB364
Ka	1996-98	Indicator, Lights, Flash, Main Beam & Dip, Front & Rear Wash Wipe			SQB366
Ka	1998>>	Indicator, Lights, Flash, Main Beam & Dip, Hazard, Front & Rear Wash Wipe			SQB367
Orion MK3	07/90-10/98	Indicator, Lights, Flash, Main Beam & Dip, Hazard, Front & Rear Wash Wipe	Without Variable Speed Adjustment		SQB352
Orion MK3	07/90-10/98	Indicator, Lights, Flash, Main Beam & Dip, Hazard, Front Wash Wipe	Without Variable Speed Adjustment		SQB353
Orion MK3	07/90-10/98	Indicator, Lights, Flash, Main Beam & Dip, Hazard, Front & Rear Wash Wipe	With Variable Speed Adjustment		SQB355
Puma	97-1998	Indicator, Lights, Flash, Main Beam & Dip, Hazard, Front & Rear Wash Wipe	Without Variable Speed Adjustment		SQB365
Puma	98-2001	Indicator, Lights, Flash, Main Beam & Dip, Hazard, Front & Rear Wash Wipe			SQB367
Transit	09/91-07/99	Indicator, Horn, Flash, Main Beam & Dip, Hazard			SQB385
Transit	09/91-07/99	Front Wash Wipe, Lights			SQB386
<b>HONDA</b>					
Concerto	1990-93	Indicator, Flash, Main Beam & Dip, Park Light			SQB140
Concerto	1990-93	Front Wash Wipe without variable speed adjustment			SQB141
Concerto	1990-93	Front & Rear Wash Wipe			SQB143
Concerto II	1993>>	Indicator, Flash, Main Beam & Dip, Park Light			SQB140
Concerto II	1993>>	Front Wash Wipe without variable speed adjustment			SQB141
Concerto II	1993>>	Front & Rear Wash Wipe			SQB143
<b>JAGUAR</b>					
S-Type	01/99-06/02	Indicator, Flash, Main Beam & Dip			SQB805
S-Type	01/99-06/02	Front Wash Wipe with variable speed adjustment	With Variable Speed Adjustment		SQB806
S-Type	01/99-06/02	Front Wash Wipe with auto setting with variable speed adjustment	With Variable Speed Adjustment With Auto Setting		SQB807



MODEL	YEAR	DESCRIPTION	ADDITIONAL INFORMATION	ICONS	PART NO.
<b>JAGUAR (DAIMLER)</b>					
Daimler Double Six 5.3	1981-86	Column Lock Switch	V12 - 5343cc		35315
Daimler Double Six 5.3	1981-90	Column Lock Switch	V12 - 5343cc		35315
Daimler Sovereign 3.4	1981-86	Column Lock Switch	6 Cyl - 3442		35315
Daimler Sovereign 4.2	1981-86	Column Lock Switch	6 Cyl - 4235		35315
Daimler Sovereign 4.2	1981-86	Column Lock Switch	6 Cyl - 4235		35315
Jaguar 3.6 to 1987	>>1987	Front Wash Wipe			SQB702
Jaguar all models 1987 on	1987>>	Front Wash Wipe			SQB702
XJ12/XJ 5.3 HE	1982-83	Front Wash Wipe	V12		SQB995
XJ6/XJ 3.4	1981-86	Column Lock Switch	{US} 6 Cyl - 3442		35315
XJ6/XJ 4.2	1981-86	Column Lock Switch	{US} 6 Cyl - 4235		35315
XJ-S Convertible 4.0 (223 bhp)	1992-94	Front Wash Wipe	(LHD) AJ6		SQB995
XJ-S Convertible 4.0 (237 bhp)	1991-94	Front Wash Wipe	(LHD) AJ6		SQB995
XJ-S Convertible 5.3 V12	1992-93	Front Wash Wipe	(LHD) AJ6		SQB995
XJ-S Convertible 6.0 V12	1993-97	Front Wash Wipe	(LHD) AJ6		SQB995
XJ-S Coupe 3.6	1983-91	Front Wash Wipe	(LHD) AJ6		SQB995
XJ-S Coupe 4.0 (223 bhp)	1991-94	Front Wash Wipe	(LHD) AJ6		SQB995
XJ-S Coupe 4.0 (237 bhp)	1994-97	Front Wash Wipe	(LHD) AJ6		SQB995
XJ-S Coupe 5.3	1981-86	Column Lock Switch	V12 - 5343cc		35315
XJ-S Coupe 5.3 HE	1981-90	Front Wash Wipe	(LHD) V12		SQB995
XJ-S Coupe 5.3 HE	1990-91	Front Wash Wipe	(LHD) V12		SQB995
XJ-S Coupe 5.3 HE	1981-86	Column Lock Switch	V12 - 5343cc		35315
XJ-SC Cabriolet 3.6	1983-87	Front Wash Wipe	(LHD) 6 Cyl		SQB995
XJ-SC Cabriolet 5.3 V12	1985-89	Front Wash Wipe	(LHD) V12		SQB995
XJ-SC Cabriolet 5.3 V12	1986-89	Front Wash Wipe	(LHD) V12		SQB995
XJ-SC Convertible 5.3 V12	1988-90	Front Wash Wipe	(LHD) V12		SQB995
XJ-SC Convertible 5.3 V12	1988-91	Front Wash Wipe	(LHD) V12		SQB995
<b>JCB</b>					
3CX Backhoe-Loader, 3D, 3DS Loader (Leyland, Perkins)	1972>>	Indicator, Horn, Lights, Flash, Main Beam & Dip			SQB992
<b>LAND ROVER</b>					
Land Rover (109) 2.25	1984-85	Park Light	4 Cyl		SQB129
Land Rover (109) 2.25	1984-85	Front Wash Wipe	4 Cyl		SQB130
Land Rover (109) 2.25	1984-85	Indicator, Horn, Flash, Main Beam	4 Cyl		SQB965
Land Rover (109) 2.25	1984-85	Indicator, Horn, Lights, Flash, Main Beam & Dip	(Issue 3) 4 Cyl		SQB968
Land Rover (109) 2.25	1972-84	Column Lock Switch	4 Cyl		39415
Land Rover (109) 2.25 Diesel	1984-85	Park Light	4 Cyl 10J		SQB129
Land Rover (109) 2.25 Diesel	1984-85	Front Wash Wipe	4 Cyl 10J		SQB130
Land Rover (109) 2.25 Diesel	1972-84	Indicator, Horn, Lights, Flash, Main Beam & Dip	(issue 3) 4 Cyl 10J		SQB968
Land Rover (109) 2.25 Diesel	1972-84	Column Lock Switch	4 Cyl 10J		39413
Land Rover (109) 2.6, Diesel	1972-78	Indicator, Horn, Lights, Flash, Main Beam & Dip	(issue 3) 6 Cyl		SQB968
Land Rover (109) 2.6, Diesel	1972-78	Column Lock Switch	6 Cyl		39415
Land Rover (109) V8	1980-85	Indicator, Horn, Lights, Flash, Main Beam & Dip	(issue 3)		SQB968
Land Rover (109) V8	1980-85	Column Lock Switch			39415
Land Rover (110) 2.25	1984-09/85	Park Light	4 Cyl		SQB129
Land Rover (110) 2.25	1984-09/85	Front Wash Wipe	4 Cyl		SQB130



MODEL	YEAR	DESCRIPTION	ADDITIONAL INFORMATION	ICONS	PART NO.
<b>LAND ROVER CONTINUED</b>					
Land Rover (110) 2.25	1984-09/85	Indicator, Horn, Flash, Main Beam	4 Cyl		SQB965
Land Rover (110) 2.25	1984-09/85	Indicator, Horn, Lights, Flash, Main Beam & Dip	(issue 3) 4 Cyl		SQB968
Land Rover (110) 2.25	1983-84	Column Lock Switch	4 Cyl		39415
Land Rover (110) 2.25 Diesel	1984-90	Park Light	4 Cyl 10J		SQB129
Land Rover (110) 2.25 Diesel	1984-90	Front Wash Wipe	4 Cyl 10J		SQB130
Land Rover (110) 2.25 Diesel	1984-09/85	Indicator, Horn, Flash, Main Beam	4 Cyl 10J		SQB965
Land Rover (110) 2.25 Diesel	1983-01/84	Indicator, Horn, Lights, Flash, Main Beam & Dip	(issue 3) 4Cyl 10J		SQB968
Land Rover (110) 2.25 Diesel	1983-84	Column Lock Switch	4 Cyl 10J		39413
Land Rover (110) 2.5	09/85-90	Park Light	4 Cyl		SQB129
Land Rover (110) 2.5	09/85-90	Front Wash Wipe	4 Cyl		SQB130
Land Rover (110) 2.5	09/85-90	Indicator, Horn, Flash, Main Beam	4 Cyl		SQB965
Land Rover (110) 2.5 Diesel	1985-90	Park Light	4 Cyl 12J		SQB129
Land Rover (110) 2.5 Diesel	1985-90	Front Wash Wipe	4 Cyl 12J		SQB130
Land Rover (110) 2.5 Diesel	1985-90	Indicator, Horn, Flash, Main Beam	4 Cyl 12J		SQB965
Land Rover (110) 2.5 Diesel	1984-90	Column Lock Switch			35289
Land Rover (110) 2.5 Turbo Diesel	1986-90	Park Light	4 Cyl		SQB129
Land Rover (110) 2.5 Turbo Diesel	1986-90	Front Wash Wipe	4 Cyl		SQB130
Land Rover (110) 2.5 Turbo Diesel	1986-90	Indicator, Horn, Flash, Main Beam	4 Cyl		SQB965
Land Rover (110) 2.5 Turbo Diesel	1986-90	Column Lock Switch			35289
Land Rover (110) V8	1985-90	Park Light			SQB129
Land Rover (110) V8	1985-90	Front Wash Wipe			SQB130
Land Rover (110) V8	1985-90	Indicator, Horn, Flash, Main Beam			SQB965
Land Rover (110) V8	1983-85	Indicator, Horn, Lights, Flash, Main Beam & Dip	(issue 3)		SQB968
Land Rover (110) V8	1983-85	Column Lock Switch			39415
Land Rover (88) 2.25, Diesel	1972-84	Column Lock Switch	(Diesel) 4 Cyl 10J - 2286cc		39413
Land Rover (88) 2.25, Diesel	1984-85	Park Light	4 Cyl		SQB129
Land Rover (88) 2.25, Diesel	1984-85	Front Wash Wipe	4 Cyl		SQB130
Land Rover (88) 2.25, Diesel	1984-85	Indicator, Horn, Flash, Main Beam	4 Cyl		SQB965
Land Rover (88) 2.25, Diesel	1984-85	Indicator, Horn, Lights, Flash, Main Beam & Dip	(issue 3) 4 Cyl		SQB968
Land Rover (88) 2.25, Diesel	1972-84	Column Lock Switch	(Not Diesel) 4 Cyl		39415
Land Rover (90) 2.5	1985-90	Park Light	4 Cyl		SQB129
Land Rover (90) 2.5	1985-90	Front Wash Wipe	4 Cyl		SQB130
Land Rover (90) 2.5	1985-90	Indicator, Horn, Flash, Main Beam	4 Cyl		SQB965
Land Rover (90) 2.5 Diesel	1985-90	Park Light	4 Cyl 12J		SQB129
Land Rover (90) 2.5 Diesel	1985-90	Front Wash Wipe	4 Cyl 12J		SQB130
Land Rover (90) 2.5 Diesel	1985-90	Indicator, Horn, Flash, Main Beam	4 Cyl 12J		SQB965
Land Rover (90) 2.5 Diesel	1985-90	Column Lock Switch			35289
Land Rover (90) 2.5 Turbo Diesel	1986-90	Park Light	4 Cyl		SQB129
Land Rover (90) 2.5 Turbo Diesel	1986-90	Front Wash Wipe	4 Cyl		SQB130
Land Rover (90) 2.5 Turbo Diesel	1986-90	Indicator, Horn, Flash, Main Beam	4 Cyl		SQB965
Land Rover (90) 2.5 Turbo Diesel	1986-90	Column Lock Switch			35289
Land Rover (90) V8	1985-90	Park Light	V8		SQB129
Land Rover (90) V8	1985-90	Front Wash Wipe	V8		SQB130
Land Rover (90) V8	1985-90	Indicator, Horn, Flash, Main Beam	V8		SQB965
Land Rover 90, 110, Defender	1983>>	Indicator, Horn, Main Beam & Dip	VIN VA104806 >>		SQB500

COLUMN SWITCHES – APPLICATION LIST



MODEL	YEAR	DESCRIPTION	ADDITIONAL INFORMATION	ICONS	PART NO.
<b>LAND ROVER CONTINUED</b>					
Land Rover 90, 110, Defender	1983-1990	Rear Fog Lights	>> VIN MA949743		SQB701
Land Rover 90, 110, Defender		Lights, Main Beam & Dip	VIN VA104806 >>		SQB709
Land Rover Defender		Indicator, Horn, Main Beam & Dip			SQB718
Land Rover Defender 110 2.5	1990-92	Park Light	4 Cyl		SQB129
Land Rover Defender 110 2.5	1990-92	Indicator, Horn, Flash, Main Beam	4 Cyl		SQB965
Land Rover Defender 110 2.5 D	1990-93	Park Light	4 Cyl		SQB129
Land Rover Defender 110 2.5 D	1990-93	Indicator, Horn, Flash, Main Beam	4 Cyl		SQB965
Land Rover Defender 110 2.5 Tdi (300)	1994-98	Park Light	4 Cyl		SQB129
Land Rover Defender 110 2.5 Tdi (300)	1994-98	Indicator, Horn, Flash, Main Beam	4 Cyl		SQB965
Land Rover Defender 110 V8	1990-95	Park Light			SQB129
Land Rover Defender 110 V8	1990-95	Indicator, Horn, Flash, Main Beam			SQB965
Land Rover Defender 130 2.5 Tdi	1990-94	Park Light	4 Cyl		SQB129
Land Rover Defender 130 2.5 Tdi	1990-94	Indicator, Horn, Flash, Main Beam	4 Cyl		SQB965
Land Rover Defender 130 V8	1990-95	Park Light			SQB129
Land Rover Defender 130 V8	1990-95	Indicator, Horn, Flash, Main Beam			SQB965
Land Rover Defender 90 2.5, 90 2.5 D, Tdi	1990-94	Park Light	4 Cyl		SQB129
Land Rover Defender 90 2.5, 90 2.5 D, Tdi	1990-94	Indicator, Horn, Flash, Main Beam	4 Cyl		SQB965
Land Rover Defender 90 V8	1990-95	Park Light	V8		SQB129
Land Rover Defender 90 V8	1990-95	Indicator, Horn, Flash, Main Beam	V8		SQB965
Land Rover Defender all models	1990>>	Front Wash Wipe	from Vin No VA104806 >>		SQB134
Land Rover Discovery	1989-94	Front Wash Wipe without variable speed adjustment			SQB707
Land Rover Discovery Mpi	1994-98	Indicator, Flash, Main Beam & Dip	T16		SQB160
Land Rover Discovery Tdi (200)	1989-92	Indicator, Horn, Lights, Flash, Main Beam & Dip, Hazard			SQB106
Land Rover Discovery Tdi (200)	1989-92	Front Wash Wipe with variable speed adjustment			SQB109
Land Rover Discovery Tdi (300)	1994-98	Front Wash Wipe with variable speed adjustment			SQB161
Land Rover Discovery V8	1989-90	Indicator, Horn, Lights, Flash, Main Beam & Dip, Hazard			SQB106
Land Rover Discovery V8	1989-90	Front Wash Wipe with variable speed adjustment			SQB109
Land Rover Discovery V8i (3.5)	1990-92	Indicator, Horn, Lights, Flash, Main Beam & Dip, Hazard			SQB106
Land Rover Discovery V8i (3.5)	1990-92	Front Wash Wipe with variable speed adjustment			SQB109
Land Rover Discovery V8i (3.9)	1994-98	Front Wash Wipe with variable speed adjustment			SQB161
Land Rover Freelander 1.8i, 2.0XEdi	10/97>>	Indicator, Flash, Main Beam & Dip			SQB160
Land Rover Freelander 1.8i, 2.0XEdi	10/97>>	Front Wash Wipe with variable speed adjustment			SQB161
Land Rover Freelander 1.8XEi	10/97>>	Indicator, Flash, Main Beam & Dip			SQB160
Land Rover Freelander 1.8XEi	10/97>>	Front Wash Wipe with variable speed adjustment			SQB161
Land Rover Freelander 1.8Xi	03/98>>	Indicator, Flash, Main Beam & Dip			SQB160
Land Rover Freelander 1.8Xi	03/98>>	Front Wash Wipe with variable speed adjustment			SQB161
Land Rover Freelander 2.0di	10/97>>	Indicator, Flash, Main Beam & Dip			SQB160

COLUMN SWITCHES – APPLICATION LIST



MODEL	YEAR	DESCRIPTION	ADDITIONAL INFORMATION	ICONS	PART NO.
<b>LAND ROVER CONTINUED</b>					
Land Rover Freelander 2.0di	10/97>>	Front Wash Wipe with variable speed adjustment			SQB161
Land Rover Freelander 2.0Xdi	03/98>>	Indicator, Flash, Main Beam & Dip			SQB160
Land Rover Freelander 2.0Xdi	03/98>>	Front Wash Wipe with variable speed adjustment			SQB161
Range Rover (II) 2.5 D	1994>>	Front Wash Wipe with variable speed adjustment			SQB161
Range Rover (II) 4.0 V8	1994>>	Front Wash Wipe with variable speed adjustment			SQB161
Range Rover (II) 4.6	1994>>	Front Wash Wipe with variable speed adjustment			SQB161
Range Rover 2.4 TD	04/86-90	Indicator, Horn, Flash, Main Beam, Hazard			SQB940
Range Rover 2.4 TD (Phase II)	04/86-90	Indicator, Horn, Lights, Flash, Main Beam & Dip			SQB114
Range Rover 2.5 TD	1989-92	Indicator, Horn, Flash, Main Beam, Hazard	4 Cyl		SQB940
Range Rover 2.5 TD (Phase II)	1989-92	Indicator, Horn, Lights, Flash, Main Beam & Dip	4 Cyl		SQB114
Range Rover 2.5 Tdi	1992-94	Indicator, Horn, Flash, Main Beam, Hazard	4 Cyl		SQB940
Range Rover 2.5 Tdi (Phase II)	1992-94	Indicator, Horn, Lights, Flash, Main Beam & Dip	(LHD) 4 Cyl		SQB114
Range Rover 3.5	1972-85	Indicator, Horn, Lights, Flash, Main Beam & Dip	Front		SQB128
Range Rover 3.5	1974-82	Indicator, Horn, Lights, Flash, Main Beam & Dip	(LHD)		SQB188
Range Rover 3.5	1972-85	Indicator, Horn, Flash, Main Beam, Hazard	Rear		SQB940
Range Rover 3.5 (Phase II)	1984-89	Indicator, Horn, Lights, Flash, Main Beam & Dip	(LHD) V8		SQB114
Range Rover 3.5 (Phase II)	1974-82	Indicator, Horn, Lights, Flash, Main Beam & Dip	(RHD) V8		SQB187
Range Rover 3.5 EFi	1986-89	Indicator, Horn, Flash, Main Beam, Hazard	V8		SQB940
Range Rover 3.5 EFi (Phase II)	1985-89	Indicator, Horn, Lights, Flash, Main Beam & Dip	(LHD) V8		SQB114
Range Rover 3.9 V8i	1989-94	Indicator, Horn, Flash, Main Beam, Hazard	V8		SQB940
Range Rover 3.9 V8i (Phase II)	1989-94	Indicator, Horn, Lights, Flash, Main Beam & Dip	(LHD)		SQB114
Range Rover 4.2 V8i	1992-94	Indicator, Horn, Flash, Main Beam, Hazard	V8		SQB940
Range Rover 4.2 V8i (Phase II)	1992-94	Indicator, Horn, Lights, Flash, Main Beam & Dip			SQB114
Range Rover Classic 2.5 Tdi	1994-96	Indicator, Flash, Main Beam & Dip			SQB160
Range Rover Classic 3.9 V8i	1994-96	Front Wash Wipe with variable speed adjustment			SQB161
Range Rover Phase II	1989-94	Front Wash Wipe without variable speed adjustment			SQB707
<b>LANDROVER</b>					
Defender	05/90>>	Front Wash Wipe			SQB719
Defender	05/90>>	Front Wash Wipe			SQB719
Defender	05/90>>	Front Wash Wipe			SQB719
<b>LEYLAND DAF</b>					
Boxer	03/78-02/84	Indicator, Horn, Lights, Flash, Main Beam & Dip			SQB992
Chieftain	1978-81	Indicator, Horn, Lights, Flash, Main Beam & Dip			SQB992



MODEL	YEAR	DESCRIPTION	ADDITIONAL INFORMATION	ICONS	PART NO.
<b>LEYLAND DAF CONTINUED</b>					
Clydesdale	01/79-81	Indicator, Horn, Lights, Flash, Main Beam & Dip			SQB992
Constructor	10/80>>	Indicator, Horn, Lights, Flash, Main Beam & Dip			SQB992
Constructor	02/85-05/89	Indicator, Flash, Main Beam, Horn	11100		33803
Cruiser	01/81-01/89	Indicator, Horn, Lights, Flash, Main Beam & Dip			SQB992
DAF 45, 55	01/95-02/00	Indicator, Horn, Flash, Main Beam & Dip			SQB142
DAF 45, 55	01/95-02/00	Front Wash Wipe			SQB144
Freighter	10/82>>	Indicator, Horn, Lights, Flash, Main Beam & Dip			SQB992
Landmaster	1981-90	Indicator, Horn, Lights, Flash, Main Beam & Dip			SQB992
Landtrain	1980-90	Indicator, Horn, Lights, Flash, Main Beam & Dip			SQB992
Mastiff	1978-81	Indicator, Horn, Lights, Flash, Main Beam & Dip			SQB992
National Single Deck Bus (Mk1)	1973-78	Indicator, Flash, Main Beam, Horn			35497
Reiver	05/78-01/79	Indicator, Horn, Lights, Flash, Main Beam & Dip			SQB992
Roadrunner FA45.120, 130, 150, 160 4x2 Drawbar, Tipper, Truck	04/91>>	Indicator, Horn, Lights, Flash, Main Beam & Dip			SQB964
Roadtrain	08/80-90	Indicator, Horn, Lights, Flash, Main Beam & Dip			SQB992
Super Mastiff	1978-81	Indicator, Horn, Lights, Flash, Main Beam & Dip			SQB992
Terrier	1978-09/84	Indicator, Horn, Lights, Flash, Main Beam & Dip			SQB992
Titan TL11 6LXB Double Deck Bus	1979>>	Indicator, Flash, Main Beam, Horn			35497
<b>LTI CARBODIES</b>					
FX Fairway 2.7D, FX4S Taxi 2.5D	1986>>	Indicator, Horn, Flash, Main Beam	TD 27, 4 Cyl 25V		SQB803
<b>MARSHALL TRACTORS</b>					
502, 602, 604, 702, 704, 802, 804 Tractor	1980-88	Indicator, Horn, Lights, Flash, Main Beam & Dip			SQB992
<b>MISCELLANEOUS</b>					
Various		Indicator, Horn, Lights, Dip, Hazard			SQB122
Various		Front Wash Wipe			33730
Various		Front Wash Wipe			33904
Various		Indicator, Main, Horn			35323
Various		Indicator, Dip, Horn			39719
Various		Indicator, Flash, Main Beam, Horn			39858
<b>MORGAN</b>					
Four Four, Plus Eight	1977>>	Indicator, Horn, Lights, Flash, Main Beam & Dip	OHV, CVH, V8		SQB119
<b>MUIR-HILL</b>					
M-H 171 Tractor	1977>>	Front Wash Wipe			SQB127
<b>NISSAN</b>					
LTI		Rotary Connector for Column Switch			SPC107
LTI		Front & Rear Wash Wipe			SQB411



MODEL	YEAR	DESCRIPTION	ADDITIONAL INFORMATION	ICONS	PART NO.
<b>NISSAN CONTINUED</b>					
Micra (K11) 1.0i	1993-98	Indicator, Flash, Main Beam & Dip, Park Light			SQB420
Micra (K11) 1.0i	1993-98	Front Wash Wipe	(Lo-line)		SQB421
Micra (K11) 1.0i	1993-98	Front & Rear Wash Wipe	(Mid-line)		SQB423
Micra (K11) 1.0i	1993-98	Front & Rear Wash Wipe	(Hi-line)		SQB425
Micra (K11) 1.3i	1993-98	Front & Rear Wash Wipe	(Hi-line)		SQB425
Primera (P10 Facelift) 2.0i	1994-96	Front Wash Wipe without variable speed adjustment			SQB407
Primera (P10 Facelift) 2.0i GT	1994-96	Front Wash Wipe with variable speed adjustment			SQB409
Primera (P10) 1.6	1990-93	Front Wash Wipe without variable speed adjustment			SQB407
Primera (P10) 1.6	1990-93	Indicator, Flash, Main Beam & Dip, Park Light			SQB420
Primera (P10) 1.6i	1992-93	Front Wash Wipe without variable speed adjustment			SQB407
Primera (P10) 1.6i	1992-93	Indicator, Flash, Main Beam & Dip, Park Light			SQB420
Primera (P10) 2.0D, 2.0i	1990-93	Front Wash Wipe without variable speed adjustment			SQB407
Primera (P10) 2.0D, 2.0i	1990-93	Indicator, Flash, Main Beam & Dip, Park Light			SQB420
Primera (P10) 2.0e	1990-92	Front Wash Wipe without variable speed adjustment			SQB407
Primera (P10) 2.0e	1990-92	Indicator, Flash, Main Beam & Dip, Park Light			SQB420
Primera (P10) 2.0i GT	1992-93	Front Wash Wipe without variable speed adjustment			SQB407
Primera (P10) 2.0i GT	1992-93	Indicator, Flash, Main Beam & Dip, Park Light			SQB420
Primera (W10) Estate 1.6, 2.0D, Estate 2.0i (85 kW/115 PS)	1990-93	Front Wash Wipe without variable speed adjustment			SQB407
Primera (W10) Estate 1.6, 2.0D, Estate 2.0i (85 kW/115 PS)	1990-93	Indicator, Flash, Main Beam & Dip, Park Light			SQB420
Serena (C23) 1.6	1991>>	Indicator, Flash, Main Beam & Dip, Park Light			SQB420
Serena (C23) 2.0 Diesel Midline	1991-95	Front & Rear Wash Wipe			SQB425
Serena (C23) 2.0 Loline	1991>>	Front Wash Wipe without variable speed adjustment			SQB407
Serena (C23) 2.0 Turbo Diesel Hiline	1991>>	Front & Rear Wash Wipe			SQB417
Serena (C23) 2.3 Diesel	1995>>	Front & Rear Wash Wipe			SQB417
Terrano II 2.4i	06/93-96	Indicator, Flash, Main Beam & Dip, Park Light			SQB420
Terrano II 2.7TD Hiline	06/93-96	Front & Rear Wash Wipe			SQB417
Terrano II 2.7TD Loline	06/93-96	Front & Rear Wash Wipe			SQB425
Terrano MK2	09/94-10/98	Front & Rear Wash Wipe (check plug terminal)	Plug Terminal With Semi Circle		SQB404
Terrano MK2	09/94-10/98	Front & Rear Wash Wipe (check plug terminal)	Plug Terminal With Square		SQB406
Terrano MK2	06/93-10/96	Front & Rear Wash Wipe with variable speed adjustment	With Variable Speed Adjustment		SQB413
<b>RELIANT</b>					
Fox, Rialto 850, Van	1982-95	Indicator, Horn, Lights, Flash, Main Beam & Dip	OHV		SQB996



MODEL	YEAR	DESCRIPTION	ADDITIONAL INFORMATION	ICONS	PART NO.
<b>RENAULT</b>					
Clio	06/90-02/96	Indicator, Horn, Lights, Flash, Main Beam & Dip, Front & Rear Fog Lamps			SQB521
Clio	02/98-06/01	Indicator, Horn, Lights, Flash, Main Beam & Dip, Rear Fog			SQB524
Clio	02/98-06/01	Rotary Connector for Column Switch			SPB332
Clio	02/98-06/01	Rotary Connector for Column Switch			SPB333
Clio	06/90-02/96	Indicator, Horn, Lights, Flash, Main Beam & Dip, Rear Fog			SQB525
Clio		Rotary Connector			SPB332
Clio		Rotary Connector			SPB333
Clio II	03/98-01/99	Indicator, Flash, Main Beam & Dip, Front Fog Lights			SQB511
Espace		Rotary Connector			SPB329
Laguna	11/93-05/98	Indicator, Horn, Lights, Flash, Main Beam & Dip, Front & Rear Fog Lamps			SQB512
Laguna	11/93-05/98	Front & Rear Wash Wipe with variable speed adjustment			SQB513
Laguna	11/93-05/98	Rotary Connector for Column Switch			SPB329
Laguna	11/93-05/98	Front & Rear Wash Wipe with variable speed adjustment			SQB530
Laguna	11/93-05/98	Rotary Connector for Column Switch			SPB336
Laguna	11/93-05/98	Rotary Connector for Column Switch			SPB337
Laguna	11/93-05/98	Indicator, Horn, Lights, Flash, Main Beam & Dip, Rear Fog			SQB516
Laguna		Rotary Connector			SPB329
Laguna		Rotary Connector			SPB336
Laguna		Rotary Connector			SPB337
Megane	96-99	Rotary Connector for Column Switch			SPB326
Megane	01/96-03/99	Rotary Connector for Column Switch			SPB326
Megane	03/99-08/02	Indicator, Flash, Main Beam & Dip, Rear Fog			SQB514
Megane	01/96-03-99	Indicator, Horn, Lights, Flash, Main Beam & Dip, Rear Fog			SQB515
Megane		Indicator, Flash, Main Beam & Dip, Rear Fog			SQB518
Megane	01/96-03/99	Indicator, Lights, Flash, Main Beam & Dip, Front & Rear Fog Lamps			SQB519
Megane	01/96-03/99	Indicator, Horn, Lights, Flash, Main Beam & Dip, Front & Rear Fog Lamps			SQB520
Megane	01/96-03/99	Rotary Connector for Column Switch			SPB331
Megane	01/96-03/99	Front & Rear Wash Wipe with variable speed adjustment			SQB522
Megane	01/96-03/99	Rotary Connector for Column Switch			SPB334
Megane	01/96-03/99	Rotary Connector for Column Switch			SPB335
Megane	03/99-08/02	Front & Rear Wash Wipe with variable speed adjustment			SQB528
Megane	03/99-08/02	Indicator, Lights, Flash, Main Beam & Dip, Front & Rear Fog Lamps			SQB523
Megane		Rotary Connector			SPB326
Megane		Rotary Connector			SPB331
Megane		Rotary Connector			SPB334
Megane		Rotary Connector			SPB335
Safrane	94-96	Rotary Connector for Column Switch			SPB328

COLUMN SWITCHES – APPLICATION LIST





MODEL	YEAR	DESCRIPTION	ADDITIONAL INFORMATION	ICONS	PART NO.
<b>RENAULT CONTINUED</b>					
Safrane		Rotary Connector			SPB328
Trafic	09/97-03/01	Front & Rear Wash Wipe			SQB529
Trafic	09/97-03/01	Indicator, Horn, Lights, Flash, Main Beam & Dip, Rear Fog			SQB517
Trafic	09/97-03/01	Rotary Connector for Column Switch			SPB330
Trafic		Rotary Connector			SPB330
Twingo	93-	Rotary Connector for Column Switch			SPB327
Twingo		Rotary Connector			SPB327
Various		Front Wash Wipe			SQB526
Various		Front Wash Wipe			SQB527
<b>ROVER</b>					
Metro 1.0	1988-90	Indicator, Horn, Lights, Flash, Main Beam & Dip, Hazard			SQB106
Metro 1.1	1990-92	Indicator, Horn, Lights, Flash, Main Beam & Dip, Hazard			SQB108
Metro 1.1	1990-92	Front Wash Wipe with variable speed adjustment			SQB109
Metro 1.1i	1991-95	Indicator, Horn, Lights, Flash, Main Beam & Dip, Hazard			SQB108
Metro 1.1i	1991-95	Front Wash Wipe with variable speed adjustment			SQB109
Metro 1.3	1988-90	Indicator, Horn, Lights, Flash, Main Beam & Dip, Hazard			SQB106
Metro 1.4	1990-92	Indicator, Horn, Lights, Flash, Main Beam & Dip, Hazard			SQB108
Metro 1.4	1990-92	Front Wash Wipe with variable speed adjustment			SQB109
Metro 1.4 Diesel	1992-95	Indicator, Horn, Lights, Flash, Main Beam & Dip, Hazard			SQB108
Metro 1.4 Diesel	1992-95	Front Wash Wipe with variable speed adjustment			SQB109
Metro 1.4 GTi 16v, Cat, 1.4i	1990-95	Indicator, Horn, Lights, Flash, Main Beam & Dip, Hazard			SQB108
Metro 1.4 GTi 16v, Cat, 1.4i	1990-95	Front Wash Wipe with variable speed adjustment			SQB109
Metro 1.4i 16v	1990-91	Indicator, Horn, Lights, Flash, Main Beam & Dip, Hazard			SQB108
Metro 1.4i 16v	1990-91	Front Wash Wipe with variable speed adjustment			SQB109
Metro 1.4i 16v Cat	1991-95	Indicator, Horn, Lights, Flash, Main Beam & Dip, Hazard			SQB108
Metro 1.4i 16v Cat	1991-95	Front Wash Wipe with variable speed adjustment			SQB109
Metro 310 Van 1.0, 1.3	1988-90	Indicator, Horn, Lights, Flash, Main Beam & Dip, Hazard			SQB106
MG Metro 1300	1988-90	Indicator, Horn, Lights, Flash, Main Beam & Dip, Hazard			SQB106
MG Metro 1300	1989-90	Front Wash Wipe with variable speed adjustment			SQB109
MG Metro Turbo	1988-90	Indicator, Horn, Lights, Flash, Main Beam & Dip, Hazard			SQB106
MG Metro Turbo	1989-90	Front Wash Wipe with variable speed adjustment			SQB109



MODEL	YEAR	DESCRIPTION	ADDITIONAL INFORMATION	ICONS	PART NO.
<b>ROVER CONTINUED</b>					
MG Midget 1300	1969-78	Indicator, Horn, Lights, Flash, Main Beam & Dip	1275 3 Cyl OHV		39309
MG Midget 1500	1975-77	Indicator, Flash, Main Beam & Dip	4 Cyl OHV		SQB118
MG Midget 1500	1978-80	Front Wash Wipe	4 Cyl OHV		SQB127
MG Midget 1500	1975-77	Indicator, Flash, Main Beam & Dip	{US} 4 Cyl OHV		SQB191
MG Midget 1500	1978-80	Indicator, Flash, Main Beam, Horn	4 Cyl OHV		SQB194
MG Midget 1500	1978-80	Indicator, Horn, Lights, Flash, Main Beam & Dip	4 Cyl OHV		SQB197
MG Midget 1500	1969-78	Indicator, Horn, Lights, Flash, Main Beam & Dip	1491 4 Cyl OHV		39309
MGB	1971-76	Indicator, Flash, Main Beam & Dip			SQB118
MGB	1977-81	Front Wash Wipe	{CA}, {JP}, {US}		SQB127
MGB	1974-76	Indicator, Flash, Main Beam & Dip	(LHD)		SQB191
MGB	1976-81	Indicator, Flash, Main Beam, Horn	1798		30893
MGB	1969-75	Indicator, Horn, Lights, Flash, Main Beam & Dip	1798 (LHD)		39309
MGB GT	1971-76	Indicator, Flash, Main Beam & Dip			SQB118
MGB GT	1977-81	Front Wash Wipe			SQB127
MGB GT	1974-76	Indicator, Flash, Main Beam & Dip	(LHD)		SQB191
MGB GT	1976-81	Indicator, Flash, Main Beam, Horn	1798		30893
MGB GT	1969-75	Indicator, Horn, Lights, Flash, Main Beam & Dip	1798 (LHD)		39309
MGF 1.8i	1995 >>	Indicator, Flash, Main Beam & Dip, Park Light			SQB183
MGR V8	1993-96	Indicator, Flash, Main Beam & Dip			SQB160
MGTF	03/02-04/05	Indicator, Lights, Flash, Main Beam & Dip			SQB156
MGTF	03/02-04/05	Front Wash Wipe			SQB158
MGTF	03/02-04/05	Indicator cancelling cam			SPC101
MGTF	03/02-04/05	Column Switch Mounting Bracket			SPC103
MGTF	03/02-04/05	Mounting Plate			SPC104
MGTF	03/02-04/05	Mounting Plate			SPC106
Mini 1/4 Ton Van	1976-80	Indicator, Horn, Lights, Flash, Main Beam & Dip			SQB166
Mini 1/4 Ton Van	1976-80	Front Wash Wipe	(LHD)		SQB167
Mini 1/4 Ton Van	1976-80	Front Wash Wipe			SQB190
Mini 1000	1985-92	Indicator, Horn, Lights, Flash, Main Beam & Dip			SQB115
Mini 1000	1985-92	Front Wash Wipe			SQB116
Mini 1000	1976-85	Front Wash Wipe			SQB167
Mini 1000	1976-85	Indicator, Horn, Lights, Flash, Main Beam & Dip			SQB189
Mini 1000	1976-80	Front Wash Wipe			SQB190
Mini 1100	1976-81	Front Wash Wipe			SQB167
Mini 1100	1976-81	Indicator, Horn, Lights, Flash, Main Beam & Dip			SQB189
Mini 1100	1976-81	Front Wash Wipe			SQB190
Mini 850	1976-80	Front Wash Wipe	(LHD)		SQB167
Mini 850	1976-80	Indicator, Horn, Lights, Flash, Main Beam & Dip			SQB189
Mini 850	1976-80	Front Wash Wipe			SQB190
Mini 95 Van	1980-83	Indicator, Horn, Lights, Flash, Main Beam & Dip	(LHD)		SQB166

COLUMN SWITCHES – APPLICATION LIST



MODEL	YEAR	DESCRIPTION	ADDITIONAL INFORMATION	ICONS	PART NO.
<b>ROVER CONTINUED</b>					
Mini 95 Van	1981-83	Front Wash Wipe			SQB167
Mini 95 Van	1980-83	Indicator, Horn, Lights, Flash, Main Beam & Dip			SQB189
Mini 95 Van	1980>>	Front Wash Wipe			SQB190
Mini Clubman 1000	1976-80	Indicator, Horn, Lights, Flash, Main Beam & Dip	(LHD)		SQB166
Mini Clubman 1000	1976-80	Front Wash Wipe	(LHD)		SQB167
Mini Clubman 1000	1976-80	Indicator, Horn, Lights, Flash, Main Beam & Dip			SQB189
Mini Clubman 1000	1976-80	Front Wash Wipe			SQB190
Mini Clubman 1100	1975-80	Indicator, Horn, Lights, Flash, Main Beam & Dip	(LHD)		SQB166
Mini Clubman 1100	1975-80	Front Wash Wipe	(LHD)		SQB167
Mini Clubman 1100	1975-80	Indicator, Horn, Lights, Flash, Main Beam & Dip			SQB189
Mini Clubman 1100	1975-80	Front Wash Wipe			SQB190
Mini Clubman 1275 GT	1976-80	Indicator, Horn, Lights, Flash, Main Beam & Dip	(LHD)		SQB166
Mini Clubman 1275 GT	1976-80	Front Wash Wipe	(LHD)		SQB167
Mini Clubman 1275 GT	1969-76	Indicator, Horn, Lights, Flash, Main Beam & Dip			SQB168
Mini Clubman 1275 GT	1976-80	Indicator, Horn, Lights, Flash, Main Beam & Dip			SQB189
Mini Clubman 1275 GT	1976-80	Front Wash Wipe			SQB190
Mini Cooper 1.3i (SPi)	1991-96	Indicator, Horn, Lights, Flash, Main Beam & Dip			SQB115
Mini Cooper 1.3i (SPi)	1991-96	Front Wash Wipe			SQB116
Mini Cooper Si	1992-96	Indicator, Horn, Lights, Flash, Main Beam & Dip			SQB115
Mini Cooper Si	1992-96	Front Wash Wipe			SQB116
Mini Pick-Up 850, 1000	1976-83	Indicator, Horn, Lights, Flash, Main Beam & Dip			SQB166
Mini Pick-Up 850, 1000	1976-83	Front Wash Wipe	(LHD)		SQB167
Mini Pick-Up 850, 1000	1980-83	Indicator, Horn, Lights, Flash, Main Beam & Dip			SQB189
Mini Pick-Up 850, 1000	1976-80	Front Wash Wipe			SQB190
Montego		Front Wash Wipe			SQB135
Rover (100) 111	1990-92	Indicator, Horn, Lights, Flash, Main Beam & Dip, Hazard			SQB108
Rover (100) 111	1990-92	Front Wash Wipe with variable speed adjustment			SQB109
Rover (100) 111i	1991-95	Indicator, Horn, Lights, Flash, Main Beam & Dip, Hazard			SQB108
Rover (100) 114	1990-92	Indicator, Horn, Lights, Flash, Main Beam & Dip, Hazard			SQB108
Rover (100) 114 GSi	1994-95	Front & Rear Wash Wipe			SQB143
Rover (100) 114 GTa	1991-94	Indicator, Horn, Lights, Flash, Main Beam & Dip, Hazard			SQB108
Rover (100) 114 GTi 16v	1990-91	Indicator, Horn, Lights, Flash, Main Beam & Dip, Hazard			SQB108
Rover (100) 114 GTi 16v	1991-94	Indicator, Horn, Lights, Flash, Main Beam & Dip, Hazard			SQB108
Rover (100) 114D	1992-94	Indicator, Horn, Lights, Flash, Main Beam & Dip, Hazard			SQB108



MODEL	YEAR	DESCRIPTION	ADDITIONAL INFORMATION	ICONS	PART NO.
<b>ROVER CONTINUED</b>					
Rover (100) 114i	1991-94	Indicator, Horn, Lights, Flash, Main Beam & Dip, Hazard			SQB108
Rover (100) 114i	1991-95	Front Wash Wipe without variable speed adjustment			SQB141
Rover (100) 114i 16v	1990-91	Indicator, Horn, Lights, Flash, Main Beam & Dip, Hazard			SQB108
Rover (100) 114i 16v	1991-94	Indicator, Horn, Lights, Flash, Main Beam & Dip, Hazard			SQB108
Rover (100) 114i 16v	1991-95	Indicator, Flash, Main Beam & Dip, Park Light			SQB140
Rover (200 II Facelift) 216 16v, Cabriolet, Coupe	1993-96	Indicator, Flash, Main Beam & Dip, Park Light			SQB140
Rover (200 II Facelift) 220 16v, GSi 16v, Turbo	1993-96	Front & Rear Wash Wipe			SQB143
Rover (200 II) 214	1990-92	Indicator, Flash, Main Beam & Dip, Park Light			SQB140
Rover (200 II) 214	1990-92	Front Wash Wipe without variable speed adjustment			SQB141
Rover (200 II) 214	1990-92	Front & Rear Wash Wipe			SQB143
Rover (200 II) 214 16v	1989-92	Indicator, Flash, Main Beam & Dip, Park Light			SQB140
Rover (200 II) 214 16v	1989-92	Front Wash Wipe without variable speed adjustment			SQB141
Rover (200 II) 214 16v	1989-92	Front & Rear Wash Wipe			SQB143
Rover (200 II) 214 Cabriolet	1992-93	Indicator, Flash, Main Beam & Dip, Park Light			SQB140
Rover (200 II) 214 Cabriolet	1992-93	Front Wash Wipe without variable speed adjustment			SQB141
Rover (200 II) 214 Cabriolet	1992-93	Front & Rear Wash Wipe			SQB143
Rover (200 II) 214 Cabriolet	1992-93	Indicator, Flash, Main Beam & Dip, Park Light			SQB183
Rover (200 II) 216	1989-92	Indicator, Flash, Main Beam & Dip, Park Light			SQB140
Rover (200 II) 216	1989-92	Front & Rear Wash Wipe			SQB143
Rover (200 II) 216 Cabriolet	1992-93	Indicator, Flash, Main Beam & Dip, Park Light			SQB140
Rover (200 II) 216 Cabriolet	1992-93	Front & Rear Wash Wipe			SQB143
Rover (200 II) 216 Coupe	1992-93	Indicator, Flash, Main Beam & Dip, Park Light			SQB140
Rover (200 II) 216 GTi Twin Cam	1990-93	Indicator, Flash, Main Beam & Dip, Park Light			SQB140
Rover (200 II) 216 GTi Twin Cam	1990-93	Front & Rear Wash Wipe			SQB143
Rover (200 II) 218D (1.7) Turbo	1991-93	Front & Rear Wash Wipe			SQB143
Rover (200 II) 218D (1.9)	1991-93	Front & Rear Wash Wipe			SQB143
Rover (200 II) 220 Coupe	1992-93	Front & Rear Wash Wipe			SQB143
Rover (200 II) 220 Turbo Coupe	1992-93	Front & Rear Wash Wipe			SQB143
Rover (200 III) 200vi	1995-97	Indicator, Flash, Main Beam & Dip, Park Light			SQB183
Rover (200 III) 214 16v	1995-97	Indicator, Flash, Main Beam & Dip, Park Light			SQB183
Rover (200 III) 216	1995-97	Indicator, Flash, Main Beam & Dip, Park Light	(CVT Auto)		SQB183
Rover (200 III) 220D, Di	1995-97	Indicator, Flash, Main Beam & Dip, Park Light			SQB183



MODEL	YEAR	DESCRIPTION	ADDITIONAL INFORMATION	ICONS	PART NO.
<b>ROVER CONTINUED</b>					
Rover (200) 216	1989-90	Front Wash Wipe without variable speed adjustment			SQB141
Rover (200) 216	1989-90	Front & Rear Wash Wipe			SQB143
Rover (200) 216 EFI	1989-90	Front Wash Wipe without variable speed adjustment			SQB141
Rover (200) 216 EFI	1989-90	Front & Rear Wash Wipe			SQB143
Rover (200) 216 Vitesse	1989-90	Front Wash Wipe without variable speed adjustment			SQB141
Rover (200) 216 Vitesse	1989-90	Front & Rear Wash Wipe			SQB143
Rover (400 Facelift) 414 16v	1992-96	Indicator, Flash, Main Beam & Dip, Park Light			SQB140
Rover (400 Facelift) 414 16v	1992-96	Front Wash Wipe without variable speed adjustment			SQB141
Rover (400 Facelift) 418D (1.7) Turbo	1992-96	Front Wash Wipe without variable speed adjustment			SQB141
Rover (400 Facelift) 418D (1.9)	1992-96	Front Wash Wipe without variable speed adjustment			SQB141
Rover (400 Facelift) 420 16v	1992-96	Front Wash Wipe without variable speed adjustment	T16		SQB141
Rover (400 Facelift) 420 GSi Sport Turbo	1992-96	Front Wash Wipe without variable speed adjustment	T16		SQB141
Rover (400 II) Hatchback 414	1995-97	Indicator, Flash, Main Beam & Dip, Park Light			SQB175
Rover (400 II) Hatchback 416	1995-97	Front & Rear Wash Wipe			SQB176
Rover (400 II) Hatchback 420	1995-97	Indicator, Flash, Main Beam & Dip, Park Light			SQB175
Rover (400) 414	1990-92	Indicator, Flash, Main Beam & Dip, Park Light			SQB140
Rover (400) 414	1991-92	Indicator, Flash, Main Beam & Dip, Park Light			SQB140
Rover (400) 414	1990-92	Front Wash Wipe without variable speed adjustment			SQB141
Rover (400) 414	1991-92	Front Wash Wipe without variable speed adjustment			SQB141
Rover (400) 416	1990-92	Front Wash Wipe without variable speed adjustment			SQB141
Rover (400) 416	1990-92	Indicator, Flash, Main Beam & Dip, Park Light			SQB140
Rover (400) 416 GTi Twin Cam	1990-92	Indicator, Flash, Main Beam & Dip, Park Light			SQB140
Rover (400) 416 GTi Twin Cam	1990-92	Front Wash Wipe without variable speed adjustment			SQB141
Rover (800 II) Coupe 827i	1992-96	Indicator, Flash, Main Beam & Dip	V6		SQB160
Rover (800 II) Coupe 827i	1992-96	Front Wash Wipe with variable speed adjustment	V6		SQB161
Rover (800 II) Fastback 820i	1991-97	Indicator, Flash, Main Beam & Dip			SQB160
Rover (800 II) Fastback 820i	1991-97	Front Wash Wipe with variable speed adjustment			SQB161
Rover (800 II) Fastback 825D	1991-97	Indicator, Flash, Main Beam & Dip			SQB160
Rover (800 II) Fastback 825D	1991-97	Front Wash Wipe with variable speed adjustment			SQB161
Rover (800 II) Fastback 827i	1991-96	Indicator, Flash, Main Beam & Dip			SQB160
Rover (800 II) Fastback 827i	1991-96	Front Wash Wipe with variable speed adjustment			SQB161
Rover (800) 820i Turbo	1991>>	Indicator, Flash, Main Beam & Dip			SQB160



MODEL	YEAR	DESCRIPTION	ADDITIONAL INFORMATION	ICONS	PART NO.
<b>ROVER CONTINUED</b>					
Rover (800) 820i Turbo	1991>>	Front Wash Wipe with variable speed adjustment			SQB161
Rover (SD1) 2000	1983-86	Indicator, Horn, Lights, Flash, Dip			SQB113
Rover (SD1) 2000	1985-87	Front Wash Wipe			35414
Rover (SD1) 2300	1983-87	Indicator, Horn, Lights, Flash, Dip			SQB113
Rover (SD1) 2300	1985-87	Front Wash Wipe			35414
Rover (SD1) 2400 SD Turbo	1983-86	Indicator, Horn, Lights, Flash, Dip			SQB113
Rover (SD1) 2400 SD Turbo	1985-87	Front Wash Wipe			35414
Rover (SD1) 2600	1983-87	Indicator, Horn, Lights, Flash, Dip			SQB113
Rover (SD1) 2600	1985-87	Front Wash Wipe			35414
Rover (SD1) 3500 V8	1983-86	Indicator, Horn, Lights, Flash, Dip			SQB113
Rover (SD1) 3500 V8	1985-87	Front Wash Wipe			35414
Rover (SD1) Vitesse	1983-86	Indicator, Horn, Lights, Flash, Dip	V8		SQB113
Rover 25	03/02-04/05	Indicator, Lights, Flash, Main Beam & Dip			SQB156
Rover 25	03/02-04/05	Front Wash Wipe			SQB158
Rover 25	10/99-04/05	Front & Rear Wash Wipe			SQB159
Rover 25	03/02-04/05	Indicator cancelling cam			SPC101
Rover 25	03/02-04/05	Column Switch Mounting Bracket			SPC103
Rover 45	02/00-04/05	Indicator, Lights, Flash, Main Beam & Dip			SQB155
Rover 45	02/00-04/05	Front & Rear Wash Wipe without variable speed adjustment	Without Variable Speed Adjustment		SQB157
Rover 45	02/00-04/05	Indicator cancelling cam			SPC102
Rover 45	02/00-04/05	Column Switch Mounting Bracket			SPC105
Rover 75	10/99-04/05	Front & Rear Wash Wipe with variable speed adjustment	With Variable Speed Adjustment		SQB154
Rover 75	10/99-04/05	Mounting Bracket for Indicator and Wash Wipe*			SPB228
Rover 75 1.8, 2.0 V6, Classic, Club, Connoisseur	06/99-04/05	Indicator, Flash, Main Beam & Dip	(no B.C)		SQB426
Rover 75 1.8, 2.0 V6, Classic, Club, Connoisseur	06/99-04/05	Indicator, Flash, Main Beam & Dip, Computer			SQB427
Rover 75 1.8, 2.0 V6, Classic, Club, Connoisseur	06/99-04/05	Front Wash Wipe with variable speed adjustment			SQB428
Rover 75 2.0 CDT, 2.5 V6 Classic, Club, Connoisseur	06/99-04/05	Indicator, Flash, Main Beam & Dip	(no B.C)		SQB426
Rover 75 2.0 CDT, 2.5 V6 Classic, Club, Connoisseur	06/99-04/05	Indicator, Flash, Main Beam & Dip, Computer			SQB427
Rover 75 2.0 CDT, 2.5 V6 Classic, Club, Connoisseur	06/99-04/05	Front Wash Wipe with variable speed adjustment			SQB428
Triumph Spitfire 1500	1976-81	Column Lock Switch			30563
Triumph Dolomite 1300, 1500, 1850 HL	1976-81	Indicator, Horn, Lights, Flash, Main Beam & Dip	4 Cyl OHV		SQB119
Triumph Dolomite Sprint 16v	1973-81	Indicator, Horn, Lights, Flash, Main Beam & Dip	4 Cyl OHC		SQB119
Triumph Spitfire 1500	1976-81	Indicator			SQB126
Triumph Spitfire 1500	1977-81	Indicator, Horn, Lights, Flash, Main Beam & Dip			SQB195
Triumph TR6 PI (125 bhp)	1975>>	Column Lock Switch			30563
Triumph TR6 PI (125 bhp)	1972-75	Indicator			SQB126
Triumph TR6 PI (125 bhp)	1972-75	Column Lock Switch			39415
Triumph TR6 PI (132/150 bhp)	1969-72	Indicator			SQB126
Triumph TR7 FH Coupe, Sprint 16v	1980-82	Indicator, Horn, Flash & Dip			SQB198
Triumph TR8 DH Coupe	1980-82	Indicator, Horn, Flash & Dip	V8		SQB198

COLUMN SWITCHES – APPLICATION LIST





MODEL	YEAR	DESCRIPTION	ADDITIONAL INFORMATION	ICONS	PART NO.
<b>SEDDON ATKINSON</b>					
200, 201, 210, 300, 301, 400	1976>>	Main Beam & Dip, Front Wash Wipe			SQB222
200, 201, 210, 300, 301, 400, 401	1976>>	Indicator, Horn, Flash & Dip			SQB223
<b>TVR</b>					
Taimar, Taimar Turbo	1977>>	Column Lock Switch			30563
<b>VAUXHALL</b>					
Agilia 1.0 12v 1.2 16v	09/00 >>	Front & Rear Wash Wipe			SQB224
Agilia 1.0 12v 1.2 16v	09/00 >>	Indicator, Flash, Main & Dip			SQB225
Astra III All models	07-92-09/98	Front & Rear Wash Wipe			SQB224
Astra III All models	07-92-09/98	Indicator, Flash, Main & Dip			SQB225
Astra IV All Models	10/98-05	Front & Rear Wash Wipe			SQB224
Calibra All Models	03/91-06/97	Front & Rear Wash Wipe			SQB224
Calibra All Models	03/91-06/97	Indicator, Flash, Main & Dip			SQB225
Caverlier III All Models	09/88-11/95	Front & Rear Wash Wipe			SQB224
Caverlier III All Models	09/88-11/95	Indicator, Flash, Main & Dip			SQB225
Corsa All Models	07/94-10/01	Front & Rear Wash Wipe			SQB224
Corsa All Models	07/94-10/01	Indicator, Flash, Main & Dip			SQB225
Omega	03/94-02/01	Front & Rear Wash Wipe			SQB224
Omega	03/94-02/01	Indicator, Flash, Main & Dip			SQB225
Sintra MPV All Models	11/96-04/99	Front & Rear Wash Wipe			SQB224
Sintra MPV All Models	11/96-04/99	Indicator, Flash, Main & Dip			SQB225
Tigra All models	07/94-12/00	Front & Rear Wash Wipe			SQB224
Tigra All models	07/94-12/00	Indicator, Flash, Main & Dip			SQB225
Vectra All Models	11/95-09/00	Front & Rear Wash Wipe			SQB224
Vectra All Models	11/95-09/00	Indicator, Flash, Main & Dip			SQB225
Zafira All Models	09/99-05	Front & Rear Wash Wipe			SQB224
<b>VAUXHALL LCV</b>					
Astramax III All models	07-92-09/98	Front & Rear Wash Wipe			SQB224
Astramax III All models	07-92-09/98	Indicator, Flash, Main & Dip			SQB225
Corsa Combo	03/93-09/00	Front & Rear Wash Wipe			SQB224
Corsa Combo	03/93-09/00	Indicator, Flash, Main & Dip			SQB225



PART NO.		PART NO.		PART NO.	
SPB228		SPB335		SQB106	
SPB326		SPB336		SQB108	
SPB327		SPB337		SQB109	
SPB328		SPC101		SQB113	
SPB329		SPC102		SQB114	
SPB330		SPC103		SQB115	
SPB331		SPC104		SQB116	
SPB332		SPC105		SQB118	
SPB333		SPC106		SQB119	
SPB334		SPC107		SQB122	

PART NO.		PART NO.		PART NO.	
SQB126		SQB142		SQB161	
SQB127		SQB143		SQB166	
SQB128		SQB144		SQB167	
SQB129		SQB154		SQB168	
SQB130		SQB155		SQB175	
SQB134		SQB156		SQB176	
SQB135		SQB157		SQB183	
SQB136		SQB158		SQB187	
SQB140		SQB159		SQB188	
SQB141		SQB160		SQB189	

COLUMN SWITCHES – PRODUCT SPECIFICATION



The power to SWITCH

COLUMN SWITCHES – PRODUCT SPECIFICATION

PART NO.		PART NO.		PART NO.	
SQB190		SQB352		SQB406	
SQB191		SQB353		SQB407	
SQB194		SQB355		SQB409	
SQB195		SQB364		SQB411	
SQB197		SQB365		SQB413	
SQB198		SQB366		SQB417	
SQB222		SQB367		SQB420	
SQB223		SQB385		SQB421	
SQB224		SQB386		SQB423	
SQB225		SQB404		SQB425	



PART NO.		PART NO.		PART NO.	
SQB426		SQB516		SQB526	
SQB427		SQB517		SQB527	
SQB428		SQB518		SQB528	
SQB429		SQB519		SQB529	
SQB500		SQB520		SQB530	
SQB511		SQB521		SQB701	
SQB512		SQB522		SQB702	
SQB513		SQB523		SQB707	
SQB514		SQB524		SQB709	
SQB515		SQB525		SQB718	



PART NO.		PART NO.		PART NO.	
SQB719		SQB991		35315	
SQB803		SQB992		35323	
SQB805		SQB995		35414	
SQB806		SQB996		35497	
SQB807		30563		39309	
SQB940		30893		39413	
SQB964		33730		39415	
SQB965		33803		39719	
SQB968		33904		39858	
SQB986		35289		54033998	



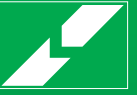

# 3

## Panel Switches

Application List

Page 3.34

Product Specification

Page 3.52

# Panel Switches



MODEL	TYPE	FUNCTION	ENGINE INFO	CC	YEAR	PART NO.
<b>ASTON MARTIN</b>						
Lagonda (5.3)	Rheostat		V8	5340	1976-85	78405
Lagonda (5.3i)	Rheostat		V8	5340	1985-90	78405
V8	Toggle Switch 2 or 3 position (57SA)	2 Position Toggle Switch	V8	5340	1977-81	31780
V8 Volante	Toggle Switch 2 or 3 position (57SA)	2 Position Toggle Switch	V8	5340	1979-81	31780
V8 Volante	Rheostat		V8	5340	1982-89	78405
Vantage (V8)	Toggle Switch 2 or 3 position (57SA)	2 Position Toggle Switch	V8	5340	1977-81	31780
Vantage (V8) Volante	Toggle Switch 2 or 3 position (57SA)	2 Position Toggle Switch	V8	5340	1986-89	31780
Vantage (V8) Volante	Rheostat		V8	5340	1986-89	78405
<b>AVELING BARFORD</b>						
400 Super Grader	Pull/Push	Push			1977 >>	SPB160
500, 600 Super Grader	Pull/Push	Push		11094	1977-79	SPB160
700 Super Grader	Pull/Push	Push			1977-79	SPB160
Centaur 35, 40, 50	Pull/Push	Push	GM 12V71N		1977-79	SPB160
Centaur 35, 40, 50	Pull/Push	Push	GM 16V71N		1977-79	SPB160
GAX Road Roller	Pull/Push	Pull/Push Switch			1977-80	SPB104
GAX Road Roller	Pull/Push	Push			1977-80	SPB160
GAY Road Roller	Pull/Push	Pull/Push Switch			1977-80	SPB104
GAY Road Roller	Pull/Push	Push			1977-80	SPB160
GRT, GRY Road Roller	Pull/Push	Pull/Push Switch		2500	1977-80	SPB104
GRT, GRY Road Roller	Pull/Push	Push		2500	1977-80	SPB160
PM20 Road Roller	Pull/Push	Push			1977-78	SPB160
RD 17 Rigid Dump Truck	Pull/Push	Push		11094	1977 >>	SPB160
RD 25, 30 Rigid Dump Truck	Pull/Push	Push			1980 >>	SPB160
RD 35, 40 Rigid Dump Truck	Pull/Push	Push			1980 >>	SPB160
RD 50 Rigid Dump Truck	Pull/Push	Push			1980 >>	SPB160
SL 340 Dump Truck	Pull/Push	Push		11094	1977 >>	SPB160
TR Road Roller	Pull/Push	Pull/Push Switch			1965-79	SPB104
TR Road Roller	Pull/Push	Push			1965-79	SPB160
TS 200 Tractor Loading Shovel	Pull/Push	Pull/Push Switch			1977 >>	SPB104
TS 200 Tractor Loading Shovel	Pull/Push	Push			1977 >>	SPB160
TS 230 Tractor Loading Shovel	Pull/Push	Pull/Push Switch			1977 >>	SPB104
TS 230 Tractor Loading Shovel	Pull/Push	Push			1977 >>	SPB160
TS 350 Tractor Loading Shovel	Pull/Push	Pull/Push Switch		11094	1977 >>	SPB104
TS 350 Tractor Loading Shovel	Pull/Push	Push		11094	1977 >>	SPB160
TS 350P, 500P Tractor Loading Shovel	Pull/Push	Pull/Push Switch			1977 >>	SPB104
TS 350P, 500P Tractor Loading Shovel	Pull/Push	Push			1977 >>	SPB160
WXL 012, 017 Wheeled Loader	Pull/Push	Pull/Push Switch			1979 >>	SPB104
WXL 012, 017 Wheeled Loader	Pull/Push	Push			1979 >>	SPB160
WXL 024 Wheeled Loader	Pull/Push	Pull/Push Switch			1979 >>	SPB104
WXL 024 Wheeled Loader	Pull/Push	Push			1979 >>	SPB160
<b>BEDFORD</b>						
M1120 Special Appliance 4x4	Panel Switch	Hazard Warning			1975-87	35476
SB, SP Coach (214), (300)	Toggle Switch 2 position (65SA / 108SA)	2 Position Toggle Switch			1969-84	SPB200
SB, SP Coach (214), (300)	Panel Switch	Hazard Warning			1975-84	35476
TJ 214, 220, 300, 330	Toggle Switch 2 position (65SA / 108SA)	2 Position Toggle Switch			1969-87	SPB200
TJ 214, 220, 300, 330	Pull/Push	Press Switch			1974-87	SPB106
TJ 214, 220, 300, 330	Panel Switch	Hazard Warning			1975-87	35476
TK 1000 (KE) 330	Toggle Switch 2 position (65SA / 108SA)	2 Position Toggle Switch			1969-86	34775
TK 1000 (KE) 330	Panel Switch	Hazard Warning			1973-86	35476
TK 1000 (KE) 330	Toggle Switch 2 position (65SA / 108SA)	2 Position Toggle Switch			1969-86	SPB200
TK 1260 (KG) 300, 330	Toggle Switch 2 position (65SA / 108SA)	2 Position Toggle Switch			1969-81	SPB200
TK 1260 (KG) 300, 330	Panel Switch	Hazard Warning			1973-86	35476
TK 1260 (KG) 330	Toggle Switch 2 position (65SA / 108SA)	2 Position Toggle Switch			1969-86	34775
TK 1260 (KG) 500	Toggle Switch 2 position (65SA / 108SA)	2 Position Toggle Switch			1975-86	34775
TK 1260 (KG) 500	Toggle Switch 2 position (65SA / 108SA)	2 Position Toggle Switch			1975-86	SPB200

PANEL SWITCHES – APPLICATION LIST





MODEL	TYPE	FUNCTION	ENGINE INFO	CC	YEAR	PART NO.
<b>BEDFORD CONTINUED</b>						
TK 1260 (KG) 500	Panel Switch	Hazard Warning			1975-86	35476
TK 1470 (KH) 500	Toggle Switch 2 position (65SA / 108SA)	2 Position Toggle Switch			1975-86	34775
TK 1470 (KH) 500	Toggle Switch 2 position (65SA / 108SA)	2 Position Toggle Switch			1976-86	SPB200
TK 1470 (KH) 500	Panel Switch	Hazard Warning			1976-86	35476
TK 1630 (KFA) 330	Toggle Switch 2 position (65SA / 108SA)	2 Position Toggle Switch			1969-86	34775
TK 1630 (KFA) 330	Toggle Switch 2 position (65SA / 108SA)	2 Position Toggle Switch			1969-86	SPB200
TK 1630 (KFA) 330	Panel Switch	Hazard Warning			1973-86	35476
TK 1630 (KM), 1930 (KGA) 500	Toggle Switch 2 position (65SA / 108SA)	2 Position Toggle Switch			1975-86	34775
TK 1630 (KM), 1930 (KGA) 500	Toggle Switch 2 position (65SA / 108SA)	2 Position Toggle Switch			1975-86	SPB200
TK 1630 (KM), 1930 (KGA) 500	Panel Switch	Hazard Warning			1975-86	35476
TK 570 (KB) 214, 220	Toggle Switch 2 position (65SA / 108SA)	2 Position Toggle Switch			1969-86	34775
TK 570 (KB, KC) 214, 220	Toggle Switch 2 position (65SA / 108SA)	2 Position Toggle Switch			1969-86	SPB200
TK 570 (KB, KC) 214, 220	Panel Switch	Hazard Warning			1973-86	35476
TK 570 (KC) 214, 220	Toggle Switch 2 position (65SA / 108SA)	2 Position Toggle Switch			1969-86	34775
TK 750 (KC) 214, 220	Toggle Switch 2 position (65SA / 108SA)	2 Position Toggle Switch			1969-86	34775
TK 750 (KC) 214, 220	Toggle Switch 2 position (65SA / 108SA)	2 Position Toggle Switch			1969-86	SPB200
TK 750 (KC) 214, 220	Panel Switch	Hazard Warning			1973-86	35476
TK 860 (KD) 330	Toggle Switch 2 position (65SA / 108SA)	2 Position Toggle Switch			1969-82	SPB200
TK 860 (KD) 330	Toggle Switch 2 position (65SA / 108SA)	2 Position Toggle Switch			1969-86	34775
TK 860 (KD) 330	Panel Switch	Hazard Warning			1973-86	35476
TL 1000, 1020, 1260 330	Panel Switch	Fog			1980-82	30669
TL 1000, 1020, 1260 330	Panel Switch	Hazard Warning			1980-82	35476
TL 1260, 1470, 1630, 1930 500	Panel Switch	Fog			1980-82	30669
TL 1260, 1470, 1630, 1930 500	Panel Switch	Hazard Warning			1980-82	35476
TL 1630 330 Turbo (107 bhp)	Panel Switch	Fog			1982-86	30669
TL 1630 330 Turbo (107 bhp)	Panel Switch	Hazard Warning			1982-86	35476
TL 570/750 214	Panel Switch	Fog			1980-86	30669
TL 570/750 214	Panel Switch	Hazard Warning			1980-86	35476
TL 570/750 220	Panel Switch	Fog			1980-82	30669
TL 570/750 220	Panel Switch	Hazard Warning			1980-82	35476
TL 860 330	Panel Switch	Fog			1980-82	30669
TL 860 330	Panel Switch	Hazard Warning			1980-82	35476
TM 1700 (EMV)	Panel Switch	Fog			1974-87	30669
TM 1700 (EMV)	Panel Switch	Hazard Warning			1974-87	35476
TM 2250 (KMX2)	Panel Switch	Fog			1975-81	30669
TM 2250 (KMX2)	Panel Switch	Hazard Warning			1975-81	35476
TM 2600 (KMX)	Panel Switch	Fog			1975-87	30669
TM 2600 (KMX)	Panel Switch	Hazard Warning			1975-87	35476
TM 3250 (ENV8, EWW8)	Panel Switch	Fog			1975-86	30669
TM 3250 (ENV8, EWW8)	Panel Switch	Hazard Warning			1975-86	35476
VAL Coach (466)	Toggle Switch 2 position (65SA / 108SA)	2 Position Toggle Switch			1969-75	SPB200
VAL Coach (500)	Panel Switch	Hazard Warning			1977-81	35476
VAM Coach (300, 466, 500)	Panel Switch	Hazard Warning			1975-87	35476
VAS Coach (214, 300, 330)	Panel Switch	Hazard Warning			1975-87	35476
YMT, YRQ, YRT	Toggle Switch 2 position (65SA / 108SA)	2 Position Toggle Switch			1975 >>	SPB200
YMT, YRQ, YRT	Panel Switch	Hazard Warning			1975 >>	35476
<b>BRAY</b>						
531 Loader	Pull/Push	Pull/Push Switch			1969-73	SPB104
532 Loader	Pull/Push	Press Switch			1969-73	SPB105
534 Loader	Pull/Push	Pull/Push Switch			1969-71	SPB104
534 Loader	Pull/Push	Press Switch			1969-71	SPB105
540 Loader	Pull/Push	Pull/Push Switch			1969-77	SPB104
540 Loader	Pull/Push	Press Switch			1969-77	SPB105



MODEL	TYPE	FUNCTION	ENGINE INFO	CC	YEAR	PART NO.
<b>BRAY CONTINUED</b>						
544 Loader	Pull/Push	Pull/Push Switch			1972-75	SPB104
544 Loader	Pull/Push	Press Switch			1972-75	SPB105
560 Loader	Panel Switch	Horn/Dip			1969-71	SPB140
562 Loader	Panel Switch	Horn/Dip			1970-77	SPB140
566 Loader	Panel Switch	Horn/Dip			1969-77	SPB140
<b>CASE INTERNATIONAL</b>						
1190 Tractor	Rotary Switch (199SA)	Rotary Light Switch			1980-83	33714
1194 Tractor	Rotary Switch (199SA)	Rotary Light Switch			1984-85	33714
1210, 1212 Tractor	Pull/Push	Press Switch			1972-81	SPB106
1290 Tractor 2WD/4WD	Rotary Switch (199SA)	Rotary Light Switch			1980-83	33714
1290 Tractor 4WD	Rotary Switch (199SA)	Rotary Light Switch		3594	1984-85	33714
1294 Tractor 2WD	Rotary Switch (199SA)	Rotary Light Switch			1980-83	33714
1390 Tractor 2WD, 4WD	Rotary Switch (199SA)	Rotary Light Switch			1980-83	33714
1394 Tractor 2WD	Rotary Switch (199SA)	Rotary Light Switch		3594	1984-88	33714
1410, 1412 Tractor	Pull/Push	Press Switch			1975-81	SPB106
1490 Tractor 2WD, 4WD	Rotary Switch (199SA)	Rotary Light Switch			1980-83	33714
1494 Tractor 2WD	Rotary Switch (199SA)	Rotary Light Switch		3594	1984-87	33714
1594 Tractor 2WD	Rotary Switch (199SA)	Rotary Light Switch		5392	1984-88	33714
1690 Tractor 2WD, 4WD	Rotary Switch (199SA)	Rotary Light Switch			1980-83	33714
1694 Tractor	Rotary Switch (199SA)	Rotary Light Switch		5392	1984-87	33714
2276 Tractor (Skid-Steer)	Pull/Push	Press Switch	BD144		1969-80	SPB105
3434 Tractor (Skid-Steer)	Pull/Push	Press Switch			1967-81	SPB105
384 Tractor	Pull/Push	Press Switch			1977-82	SPB105
384 Tractor	Rotary Switch (199SA)	Rotary Light Switch			1981-82	33714
444 Tractor	Pull/Push	Press Switch			1963-82	SPB105
484 Tractor	Pull/Push	Press Switch			1977-82	SPB105
484 Tractor	Rotary Switch (199SA)	Rotary Light Switch			1981 >>	33714
485L Tractor	Rotary Switch (199SA)	Rotary Light Switch		2934	1981 >>	33714
500 Payloader	Pull/Push	Press Switch			1975-78	SPB106
500 Payloader (LPG)	Pull/Push	Press Switch			1975-78	SPB106
585L Tractor	Rotary Switch (199SA)	Rotary Light Switch		3382	1981-82	33714
585L Tractor	Pull/Push	Press Switch		3382	1981-82	SPB105
684 Tractor	Pull/Push	Press Switch			1977-80	SPB105
685L Tractor	Rotary Switch (199SA)	Rotary Light Switch	D239	3917	1981 >>	33714
784 Tractor	Pull/Push	Press Switch			1977-80	SPB105
785L Tractor	Rotary Switch (199SA)	Rotary Light Switch	D246	4037	1981-85	33714
885G Tractor (Diesel)	Pull/Push	Press Switch			1972-83	SPB106
885G Tractor (Petrol)	Pull/Push	Press Switch			1972-81	SPB106
885L Tractor	Pull/Push	Press Switch			1972-83	SPB106
885L Tractor	Rotary Switch (199SA)	Rotary Light Switch			1981-83	33714
885N Tractor (Diesel)	Pull/Push	Press Switch			1972-83	SPB106
885N Tractor (Petrol)	Pull/Push	Press Switch			1972-81	SPB106
B 125 A Excavator	Toggle Switch 2 or 3 position (57SA)	3 Position Toggle Switch	BD281		1975-76	31788
B 165 Excavator	Toggle Switch 2 or 3 position (57SA)	3 Position Toggle Switch			1977-82	31788
H 85 Tractor	Rotary Switch (199SA)	Rotary Light Switch	D246		1981-85	33714
TD 8 A Crawler Tractor	Toggle Switch 2 or 3 position (57SA)	3 Position Toggle Switch	D239	3917	1975-83	31788
<b>CONVEYANCER</b>						
E2, E2C, E3, E3C, E4, E5, E6, E7, E8	Pull/Push	Push			1973-78	SPB160
RE2A, RE3A	Pull/Push	Push			1973-78	SPB160
TC4 Fork Lift	Toggle Switch 2 or 3 position (57SA)	3 Position Toggle Switch		3300	1973-83	31788
TC4 Fork Lift	Pull/Push	Push		3300	1973-83	SPB160
TC5 Fork Lift, TC6 Fork Lift	Toggle Switch 2 or 3 position (57SA)	3 Position Toggle Switch		3300	1973-83	31788
TC5 Fork Lift, TC6 Fork Lift	Pull/Push	Push		3300	1973-83	SPB160
TC7 Fork Lift	Toggle Switch 2 or 3 position (57SA)	3 Position Toggle Switch		3860	1973-83	31788
TC7 Fork Lift	Pull/Push	Push		3860	1973-83	SPB160
<b>DENNIS EAGLE</b>						
Alley Cat Municipal	Toggle Switch 2 or 3 position (57SA)	3 Position Toggle Switch		3860	1976-80	31788

PANEL SWITCHES – APPLICATION LIST

MODEL	TYPE	FUNCTION	ENGINE INFO	CC	YEAR	PART NO.
<b>DENNIS EAGLE</b>						
Alley Cat Municipal	Toggle Switch 2 or 3 position (57SA)	3 Position Toggle Switch		3860	1976-80	31788
Alley Cat Municipal	Toggle Switch 2 position (65SA / 108SA)	2 Position Toggle Switch		3860	1976-80	SPB200
Bulkmaster 50, 70 Municipal	Toggle Switch 2 or 3 position (57SA)	3 Position Toggle Switch			1972-83	31788
Bulkmaster 50, 70 Municipal	Toggle Switch 2 position (65SA / 108SA)	2 Position Toggle Switch			1972-83	SPB200
Bulkmaster 50, 70 Municipal	Pull/Push	Press Switch			1972-83	SPB105
Bulkmaster 50, 70 Municipal	Panel Switch	Hazard Warning			1979-83	35476
Mini Bulkmaster Municipal	Toggle Switch 2 or 3 position (57SA)	3 Position Toggle Switch		5800	1972-79	31788
Mini Bulkmaster Municipal	Toggle Switch 2 position (65SA / 108SA)	2 Position Toggle Switch		5800	1972-79	SPB200
Mini Bulkmaster Municipal	Pull/Push	Press Switch		5800	1972-79	SPB105
Municipal Gully Emptier	Toggle Switch 2 or 3 position (57SA)	3 Position Toggle Switch			1972-79	31788
Municipal Gully Emptier	Toggle Switch 2 position (65SA / 108SA)	2 Position Toggle Switch			1972-79	SPB200
Municipal Gully Emptier	Pull/Push	Press Switch			1972-79	SPB105
<b>DENNIS SPECIALIST VEHICLES</b>						
Delta 16	Panel Switch	Hazard Warning		5800	1979 >>	35476
Delta II	Toggle Switch 2 or 3 position (57SA)	3 Position Toggle Switch		8830	1975-85	31788
Delta II	Toggle Switch 2 position (65SA / 108SA)	2 Position Toggle Switch		8830	1975-85	SPB200
Delta III	Toggle Switch 2 or 3 position (57SA)	3 Position Toggle Switch		8830	1975-85	31788
Delta III	Toggle Switch 2 position (65SA / 108SA)	2 Position Toggle Switch		8830	1975-85	SPB200
Dominant	Toggle Switch 2 or 3 position (57SA)	3 Position Toggle Switch			1972-79	31788
Dominant	Toggle Switch 2 position (65SA / 108SA)	2 Position Toggle Switch			1972-79	SPB200
Dominant	Pull/Push	Press Switch			1972-79	SPB105
Dominator Double Deck Bus	Toggle Switch 2 or 3 position (57SA)	2 Position Toggle Switch		10450	1978 >>	31780
Dominator Double Deck Bus	Toggle Switch 2 or 3 position (57SA)	3 Position Toggle Switch		10450	1978 >>	31788
Dominator Double Deck Bus	Toggle Switch 2 position (65SA / 108SA)	2 Position Toggle Switch		10450	1978 >>	SPB200
Dominator Double Deck Bus	Pull/Push	Press Switch		10450	1978 >>	SPB105
Domino PSV Chassis	Toggle Switch 2 or 3 position (57SA)	3 Position Toggle Switch		5800		31788
Domino PSV Chassis	Toggle Switch 2 position (65SA / 108SA)	2 Position Toggle Switch		5800		SPB200
Domino PSV Chassis	Pull/Push	Press Switch		5800		SPB105
Fire Engine: D Range	Toggle Switch 2 or 3 position (57SA)	3 Position Toggle Switch		4235	1972-76	31788
Fire Engine: D Range	Toggle Switch 2 position (65SA / 108SA)	2 Position Toggle Switch		4235	1972-76	SPB200
Fire Engine: D Range	Pull/Push	Press Switch		4235	1972-76	SPB105
Fire Engine: F Range	Toggle Switch 2 or 3 position (57SA)	3 Position Toggle Switch			1972-79	31788
Fire Engine: F Range	Toggle Switch 2 position (65SA / 108SA)	2 Position Toggle Switch			1972-79	SPB200
Fire Engine: F Range	Pull/Push	Press Switch			1972-79	SPB105
Fire Engine: R Range	Ignition Switch (128SA)	Ignition Switch 3 Position			1978-79	33940
Fire Engine: R Range	Toggle Switch 2 or 3 position (57SA)	3 Position Toggle Switch			1978-79	31788
Fire Engine: R Range	Toggle Switch 2 position (65SA / 108SA)	2 Position Toggle Switch			1978-79	SPB200
Fire Engine: R Range	Pull/Push	Press Switch			1978-79	SPB105
Fire Engine: RS Range	Panel Switch	Hazard Warning			1979 >>	35476
Jubilant PSV Chassis	Toggle Switch 2 or 3 position (57SA)	2 Position Toggle Switch		10450	1978 >>	31780



MODEL	TYPE	FUNCTION	ENGINE INFO	CC	YEAR	PART NO.
<b>ERF</b>						
84 PF, PFS, PS Fire Appliance	Toggle Switch 2 or 3 position (57SA)	2 Position Toggle Switch			1969-79	<b>31780</b>
84 PF, PFS, PS Fire Appliance	Toggle Switch 2 or 3 position (57SA)	3 Position Toggle Switch			1969-79	<b>31788</b>
84 PF, PFS, PS Fire Appliance	Pull/Push	Push			1969-79	<b>SPB160</b>
84 PF, PFS, PS Fire Appliance	Rocker Switch (159SA)	Front Wiper Switch Two Speed			1972-79	<b>39710</b>
84 PF, PFS, PS Fire Appliance	Panel Switch	Hazard Warning			1974-79	<b>35476</b>
84 RFS, RS Fire Appliance	Toggle Switch 2 or 3 position (57SA)	2 Position Toggle Switch			1969-79	<b>31780</b>
84 RFS, RS Fire Appliance	Toggle Switch 2 or 3 position (57SA)	3 Position Toggle Switch			1969-79	<b>31788</b>
84 RFS, RS Fire Appliance	Pull/Push	Push			1969-79	<b>SPB160</b>
84 RFS, RS Fire Appliance	Rocker Switch (159SA)	Front Wiper Switch Two Speed			1972-79	<b>39710</b>
84 RFS, RS Fire Appliance	Panel Switch	Hazard Warning			1974-79	<b>35476</b>
86 PS, RS Fire Appliance	Toggle Switch 2 or 3 position (57SA)	2 Position Toggle Switch			1969-79	<b>31780</b>
86 PS, RS Fire Appliance	Toggle Switch 2 or 3 position (57SA)	3 Position Toggle Switch			1969-79	<b>31788</b>
86 PS, RS Fire Appliance	Pull/Push	Push			1969-79	<b>SPB160</b>
86 PS, RS Fire Appliance	Rocker Switch (159SA)	Front Wiper Switch Two Speed			1972-79	<b>39710</b>
86 PS, RS Fire Appliance	Panel Switch	Hazard Warning			1974-79	<b>35476</b>
B34 G2 4x2	Toggle Switch 2 or 3 position (57SA)	2 Position Toggle Switch		10450	1979-81	<b>31780</b>
B34 G2 4x2	Panel Switch	Hazard Warning		10450	1979-80	<b>35476</b>
B35 R2LT 4x2 (R-Royce Eagle 220)	Toggle Switch 2 or 3 position (57SA)	2 Position Toggle Switch		12170	1980-81	<b>31780</b>
B35 R2LT 4x2 (R-Royce Eagle 220)	Panel Switch	Hazard Warning		12170	1980	<b>35476</b>
B38 G2 4x2	Toggle Switch 2 or 3 position (57SA)	2 Position Toggle Switch		13930	1975-81	<b>31780</b>
B38 G2 4x2	Panel Switch	Hazard Warning		13930	1976-80	<b>35476</b>
C25 C3 6x4	Toggle Switch 2 or 3 position (57SA)	2 Position Toggle Switch		10013	1983-86	<b>31780</b>
C25 G3 6x4	Toggle Switch 2 or 3 position (57SA)	2 Position Toggle Switch		10450	1981-86	<b>31780</b>
C31 C4 8x4 (Cummins)	Toggle Switch 2 or 3 position (57SA)	2 Position Toggle Switch		14000	1983-86	<b>31780</b>
C31 R4 8x4 (Rolls-Royce)	Toggle Switch 2 or 3 position (57SA)	2 Position Toggle Switch		12170	1983-86	<b>31780</b>
C36 C2 4x2 (Cummins)	Toggle Switch 2 or 3 position (57SA)	2 Position Toggle Switch		14000	1982-84	<b>31780</b>
C36 G2 4x2	Toggle Switch 2 or 3 position (57SA)	2 Position Toggle Switch		10450	1982-85	<b>31780</b>
C36 R2 4x2	Toggle Switch 2 or 3 position (57SA)	2 Position Toggle Switch		12170	1982-84	<b>31780</b>
C38 C2 4x2	Toggle Switch 2 or 3 position (57SA)	2 Position Toggle Switch		10013	1984-86	<b>31780</b>
C38 G2 4x2	Toggle Switch 2 or 3 position (57SA)	2 Position Toggle Switch		13930	1981-86	<b>31780</b>
C40 C2 4x2	Toggle Switch 2 or 3 position (57SA)	2 Position Toggle Switch		14000	1982-86	<b>31780</b>
C40 G2 4x2	Toggle Switch 2 or 3 position (57SA)	2 Position Toggle Switch		13930	1981-86	<b>31780</b>
C40 R2 4x2 (265L)	Toggle Switch 2 or 3 position (57SA)	2 Position Toggle Switch		12170	1985-86	<b>31780</b>
C40 R2 4x2 (290Li)	Toggle Switch 2 or 3 position (57SA)	2 Position Toggle Switch		12170	1982-85	<b>31780</b>
M16 G2 4x2 (FC) Truck	Toggle Switch 2 or 3 position (57SA)	2 Position Toggle Switch		10450	1983-86	<b>31780</b>
M16 P2 4x2 (FC) Truck	Toggle Switch 2 or 3 position (57SA)	2 Position Toggle Switch		5800	1983-86	<b>31780</b>
<b>FODEN</b>						
S21 FC	Toggle Switch 2 or 3 position (57SA)	2 Position Toggle Switch			1969-79	<b>31780</b>
S21 FC	Toggle Switch 2 position (65SA / 108SA)	2 Position Toggle Switch			1969-79	<b>SPB204</b>

PANEL SWITCHES – APPLICATION LIST



MODEL	TYPE	FUNCTION	ENGINE INFO	CC	YEAR	PART NO.
<b>FODEN CONTINUED</b>						
S21 FC	Panel Switch	Horn/Dip			1969-79	SPB140
S21 FG	Toggle Switch 2 or 3 position (57SA)	2 Position Toggle Switch			1969-78	31780
S21 FG	Toggle Switch 2 position (65SA / 108SA)	2 Position Toggle Switch			1973-78	SPB204
S21 FG	Panel Switch	Horn/Dip			1969-78	SPB140
S39	Toggle Switch 2 or 3 position (57SA)	2 Position Toggle Switch			1969-79	31780
S39	Toggle Switch 2 position (65SA / 108SA)	2 Position Toggle Switch			1969-79	SPB204
S39	Panel Switch	Horn/Dip			1969-79	SPB140
S50 (Steel Cab)	Toggle Switch 2 or 3 position (57SA)	2 Position Toggle Switch			1969-72	31780
S50 (Steel Cab)	Toggle Switch 2 position (65SA / 108SA)	2 Position Toggle Switch			1969-72	SPB204
S50 (Steel Cab)	Panel Switch	Horn/Dip			1969-72	SPB140
<b>FORD</b>						
Escort	Switch	Electric Window Switch			95-01	SPB315
Escort	Switch	Electric Window / Boot Switch			95-01	SPB316
Fiesta	Switch	Electric Window Switch			01-	SPB314
Fiesta	Switch	Electric Window Switch			95-01	SPB314
Fusion	Switch	Electric Window Switch			01-	SPB314
Ka	Switch	Electric Window Switch			96-	SPB314
Puma	Switch	Electric Window Switch			97-01	SPB314
Street Ka	Switch	Electric Window Switch			03-05	SPB314
Transit	Rocker Switch	Hazard Light Switch			09/81-01/91	SPB310
Transit Connect	Switch	Electric Window Switch			02-	SPB314
<b>HONDA</b>						
Civic IV, V	Switch	Courtesy Light Switch			09/94-01/97	SPB222
<b>INTERNATIONAL</b>						
International Harvester TX19	Panel Switch	Rotary Panel Switch				SPB107
<b>JAGUAR (DAIMLER)</b>						
Daimler Double Six 5.3	Miniature Rocker Switch (183SA)	Electric Window Lift Switch Master	V12	5343	1974-79	39980
Daimler Limousine	Pull/Push	Pull/Push Switch	6 Cyl	4235	1969-92	SPB104
Daimler Limousine	Miniature Rocker Switch (183SA)	Electric Window Lift Switch Master	6 Cyl	4235	1975-92	39980
Daimler Limousine	Panel Switch	Hazard Warning	6 Cyl	4235	1979-89	39976
Daimler Sovereign 3.4	Miniature Rocker Switch (183SA)	Electric Window Lift Switch Master	6 Cyl	3442	1975-77	39980
Daimler Sovereign 4.2	Miniature Rocker Switch (183SA)	Electric Window Lift Switch Master	6 Cyl	4235	1974-79	39980
Sovereign 4.2	Miniature Rocker Switch (183SA)	Electric Window Lift Switch Master	6 Cyl	4235	1983-86	39980
Sovereign 5.3 HE	Miniature Rocker Switch (183SA)	Electric Window Lift Switch Master	V12	5343	1983-89	39980
XJ12/XJ 5.3	Miniature Rocker Switch (183SA)	Electric Window Lift Switch Master	V12	5343	1975	39980
XJ12/XJ 5.3 HE	Miniature Rocker Switch (183SA)	Electric Window Lift Switch Master	V12	5343	1981-83	39980
XJ6/XJ 3.4	Miniature Rocker Switch (183SA)	Electric Window Lift Switch Master	6 Cyl	3442	1975-86	39980
XJ6/XJ 4.2	Miniature Rocker Switch (183SA)	Electric Window Lift Switch Master	6 Cyl	4235	1975-79	39980
XJ-S Convertible 4.0 (223 bhp)	Miniature Rocker Switch (183SA)	Electric Window Lift Switch Master	AJ6	3980	1992-94	39980
XJ-S Convertible 4.0 (237 bhp)	Miniature Rocker Switch (183SA)	Electric Window Lift Switch Master	AJ6	3980	1983-94	39980
XJ-S Convertible 5.3 V12	Miniature Rocker Switch (183SA)	Electric Window Lift Switch Master	AJ6		1992-93	39980
XJ-S Convertible 6.0 V12	Miniature Rocker Switch (183SA)	Electric Window Lift Switch Master	AJ6		1993-94	39980
XJ-S Coupe 3.6	Miniature Rocker Switch (183SA)	Electric Window Lift Switch Master	AJ6	3590	1983-91	39980



MODEL	TYPE	FUNCTION	ENGINE INFO	CC	YEAR	PART NO.
<b>JAGUAR (DAIMLER) CONTINUED</b>						
XJ-S Coupe 4.0 (223 bhp)	Miniature Rocker Switch (183SA)	Electric Window Lift Switch Master	AJ6	3980	1991-94	<b>39980</b>
XJ-S Coupe 4.0 (237 bhp)	Miniature Rocker Switch (183SA)	Electric Window Lift Switch Master	AJ6	3980	1994-97	<b>39980</b>
XJ-S Coupe 5.3 HE	Miniature Rocker Switch (183SA)	Electric Window Lift Switch Master	V12	5343	1981-90	<b>39980</b>
XJ-S Coupe 5.3 HE	Miniature Rocker Switch (183SA)	Electric Window Lift Switch Master	V12	5345	1990-91	<b>39980</b>
XJ-SC Cabriolet 3.6	Miniature Rocker Switch (183SA)	Electric Window Lift Switch Master	6 Cyl	3590	1983-87	<b>39980</b>
XJ-SC Cabriolet 5.3 V12	Miniature Rocker Switch (183SA)	Electric Window Lift Switch Master	V12	5343	1985-89	<b>39980</b>
XJ-SC Cabriolet 5.3 V12	Miniature Rocker Switch (183SA)	Electric Window Lift Switch Master	V12	5343	1986-89	<b>39980</b>
XJ-SC Convertible 5.3 V12	Miniature Rocker Switch (183SA)	Electric Window Lift Switch Master	V12	5343	1988-90	<b>39980</b>
XJ-SC Convertible 5.3 V12	Miniature Rocker Switch (183SA)	Electric Window Lift Switch Master	V12	5345	1988-91	<b>39980</b>
<b>JCB</b>						
2D Loader (Leyland 384/4)	Toggle Switch 2 or 3 position (57SA)	3 Position Toggle Switch			>> 1980	<b>31743</b>
2D Loader (Leyland 4/65)	Toggle Switch 2 or 3 position (57SA)	3 Position Toggle Switch			1971-80	<b>31743</b>
3 Loader (Leyland 384/4)	Toggle Switch 2 or 3 position (57SA)	3 Position Toggle Switch			1972 >>	<b>31743</b>
3 Loader (Leyland 4/65)	Toggle Switch 2 or 3 position (57SA)	3 Position Toggle Switch			1971 >>	<b>31743</b>
3C Loader (Leyland 384/4)	Toggle Switch 2 or 3 position (57SA)	3 Position Toggle Switch			1972-80	<b>31743</b>
3C Loader (Leyland 4/65)	Toggle Switch 2 or 3 position (57SA)	3 Position Toggle Switch			1971-80	<b>31743</b>
3D Loader (Leyland 384/4)	Toggle Switch 2 or 3 position (57SA)	3 Position Toggle Switch			1972-80	<b>31743</b>
3D Loader (Leyland 4/65)	Toggle Switch 2 or 3 position (57SA)	3 Position Toggle Switch			1971 >>	<b>31743</b>
410 Loader	Pull/Push	Press Switch		3860	1982-94	<b>SPB106</b>
413 Loader	Pull/Push	Press Switch		5800	1973-83	<b>SPB106</b>
413 Loader	Panel Switch	Hazard Warning		5800	1980-83	<b>39976</b>
418 Loader (Articulated)	Pull/Push	Press Switch		5800	1973-83	<b>SPB106</b>
418 Loader (Articulated)	Panel Switch	Hazard Warning		5800	1980-83	<b>39976</b>
4D Loader (Leyland 384/4)	Toggle Switch 2 or 3 position (57SA)	3 Position Toggle Switch			1972-80	<b>31743</b>
4D Loader (Leyland 4/65)	Toggle Switch 2 or 3 position (57SA)	3 Position Toggle Switch			1969-80	<b>31743</b>
805B Excavator	Pull/Push	Press Switch		5800	1978-82	<b>SPB106</b>
805BT Excavator	Pull/Push	Press Switch		3860	1982 >>	<b>SPB106</b>
<b>JONES CRANES</b>						
Iron Fairy Garnet, Opal Mobile Crane	Pull/Push	Push			1971-78	<b>SPB160</b>
Iron Fairy Sapphire 6, 7, 8 Ton Mobile Crane	Pull/Push	Push			1971-78	<b>SPB160</b>
Iron Fairy Six 6, 8, 10 Ton Mobile Crane	Pull/Push	Push			1971-80	<b>SPB160</b>
Iron Fairy Tourmaline	Pull/Push	Push			1973-78	<b>SPB160</b>
<b>LANCER BOSS</b>						
BD20, 23, 26 Fork Lift (LPG)	Rotary Switch (SD84)	Di Switch With Warning Light		6220		<b>SPB120</b>
BD20, 23, 26 Fork Lift (LPG)	Pull/Push	Pull/Push Switch		6220		<b>SPB104</b>
CD15, 18, 20 Fork Lift (LPG)	Rotary Switch (SD84)	Di Switch With Warning Light		6220		<b>SPB120</b>
CD15, 18, 20 Fork Lift (LPG)	Pull/Push	Pull/Push Switch		6220		<b>SPB104</b>
<b>LAND ROVER</b>						
Land Rover Series II , Ila	Panel Switch				1966-1970	<b>SQB700</b>
Land Rover (109) 2.25	Toggle Switch 2 or 3 position (57SA)	3 Position Toggle Switch	4 Cyl	2286	1969-84	<b>31788</b>
Land Rover (109) 2.25	Toggle Switch 2 position (65SA / 108SA)	2 Position Toggle Switch	4 Cyl	2286	1969-84	<b>34775</b>
Land Rover (109) 2.25	Rotary Switch (145SA)	Rotary Wash Wipe Switch	4 Cyl		1972-84	<b>SQB967</b>

PANEL SWITCHES – APPLICATION LIST



MODEL	TYPE	FUNCTION	ENGINE INFO	CC	YEAR	PART NO.
<b>LAND ROVER CONTINUED</b>						
Land Rover (109) 2.25	Toggle Switch 2 position (65SA / 108SA)	2 Position Toggle Switch	4 Cyl	2286	1975-84	<b>SPB200</b>
Land Rover (109) 2.25	Miniature Rocker Switch (183SA)	Hazard Warning Switch Rocker	4 Cyl	2286	1984-85	<b>35367</b>
Land Rover (109) 2.25	Panel Switch	Hazard Warning	4 Cyl	2286	1976-84	<b>39364</b>
Land Rover (109) 2.25 Diesel	Toggle Switch 2 or 3 position (57SA)	3 Position Toggle Switch	4 Cyl 10J	2286	1969-84	<b>31788</b>
Land Rover (109) 2.25 Diesel	Toggle Switch 2 position (65SA / 108SA)	2 Position Toggle Switch	4 Cyl 10J	2286	1969-84	<b>34775</b>
Land Rover (109) 2.25 Diesel	Rotary Switch (145SA)	Rotary Wash Wipe Switch	4 Cyl 10J		1972-84	<b>SQB967</b>
Land Rover (109) 2.25 Diesel	Toggle Switch 2 position (65SA / 108SA)	2 Position Toggle Switch	4 Cyl 10J	2286	1975-84	<b>SPB200</b>
Land Rover (109) 2.25 Diesel	Miniature Rocker Switch (183SA)	Hazard Warning Switch Rocker	4 Cyl 10J	2286	1984-85	<b>35367</b>
Land Rover (109) 2.25 Diesel	Panel Switch	Hazard Warning	4 Cyl 10J	2286	1976-84	<b>39364</b>
Land Rover (109) 2.6, Diesel	Toggle Switch 2 or 3 position (57SA)	3 Position Toggle Switch	6 Cyl	2625	1969-78	<b>31788</b>
Land Rover (109) 2.6, Diesel	Toggle Switch 2 position (65SA / 108SA)	2 Position Toggle Switch	6 Cyl	2625	1969-78	<b>34775</b>
Land Rover (109) 2.6, Diesel	Rotary Switch (145SA)	Rotary Wash Wipe Switch	6 Cyl		1972-78	<b>SQB967</b>
Land Rover (109) 2.6, Diesel	Toggle Switch 2 position (65SA / 108SA)	2 Position Toggle Switch	6 Cyl	2625	1975-78	<b>SPB200</b>
Land Rover (109) 2.6, Diesel	Panel Switch	Hazard Warning	6 Cyl	2625	1976-78	<b>39364</b>
Land Rover (109) V8	Toggle Switch 2 or 3 position (57SA)	3 Position Toggle Switch		3528	1980-85	<b>31788</b>
Land Rover (109) V8	Toggle Switch 2 position (65SA / 108SA)	2 Position Toggle Switch		3528	1980-85	<b>34775</b>
Land Rover (109) V8	Toggle Switch 2 position (65SA / 108SA)	2 Position Toggle Switch		3528	1980-85	<b>SPB200</b>
Land Rover (109) V8	Rotary Switch (145SA)	Rotary Wash Wipe Switch			1980-85	<b>SQB967</b>
Land Rover (110) 2.25	Toggle Switch 2 or 3 position (57SA)	3 Position Toggle Switch	(Forward Control) 4 Cyl	2286	1969-72	<b>31788</b>
Land Rover (110) 2.25	Toggle Switch 2 position (65SA / 108SA)	2 Position Toggle Switch	(Forward Control) Front 4 Cyl	2286	1969-72	<b>34775</b>
Land Rover (110) 2.25	Toggle Switch 2 or 3 position (57SA)	3 Position Toggle Switch	4 Cyl	2286	1983-84	<b>31788</b>
Land Rover (110) 2.25	Toggle Switch 2 position (65SA / 108SA)	2 Position Toggle Switch	4 Cyl	2286	1983-84	<b>34775</b>
Land Rover (110) 2.25	Toggle Switch 2 position (65SA / 108SA)	2 Position Toggle Switch	4 Cyl	2286	1983-84	<b>SPB200</b>
Land Rover (110) 2.25	Rotary Switch (145SA)	Rotary Wash Wipe Switch	4 Cyl		1983-84	<b>SQB967</b>
Land Rover (110) 2.25	Miniature Rocker Switch (183SA)	Hazard Warning Switch Rocker	4 Cyl	2286	1984-09/85	<b>35367</b>
Land Rover (110) 2.25	Panel Switch	Hazard Warning	4 Cyl	2286	1983-84	<b>39364</b>
Land Rover (110) 2.25 Diesel	Rotary Switch (145SA)	Rotary Wash Wipe Switch	4 Cyl 10J		1983-01/84	<b>SQB967</b>
Land Rover (110) 2.25 Diesel	Toggle Switch 2 or 3 position (57SA)	3 Position Toggle Switch	4 Cyl 10J	2286	1983-84	<b>31788</b>
Land Rover (110) 2.25 Diesel	Toggle Switch 2 position (65SA / 108SA)	2 Position Toggle Switch	4 Cyl 10J	2286	1983-84	<b>34775</b>
Land Rover (110) 2.25 Diesel	Toggle Switch 2 position (65SA / 108SA)	2 Position Toggle Switch	4 Cyl 10J	2286	1983-84	<b>SPB200</b>
Land Rover (110) 2.25 Diesel	Miniature Rocker Switch (183SA)	Hazard Warning Switch Rocker	4 Cyl 10J	2286	1984-09/85	<b>35367</b>
Land Rover (110) 2.25 Diesel	Panel Switch	Hazard Warning	4 Cyl 10J	2286	1983-84	<b>39364</b>
Land Rover (110) 2.5	Miniature Rocker Switch (183SA)	Hazard Warning Switch Rocker	4 Cyl	2495	09/85-90	<b>35367</b>
Land Rover (110) 2.5 Diesel	Miniature Rocker Switch (183SA)	Hazard Warning Switch Rocker	4 Cyl 12J	2495	1984-90	<b>35367</b>
Land Rover (110) 2.5 Turbo Diesel	Miniature Rocker Switch (183SA)	Hazard Warning Switch Rocker	4 Cyl	2495	1986-90	<b>35367</b>
Land Rover (110) V8	Toggle Switch 2 position (65SA / 108SA)	2 Position Toggle Switch		3528	1983-85	<b>34775</b>
Land Rover (110) V8	Toggle Switch 2 position (65SA / 108SA)	2 Position Toggle Switch		3528	1983-85	<b>SPB200</b>
Land Rover (110) V8	Rotary Switch (145SA)	Rotary Wash Wipe Switch			1983-85	<b>SQB967</b>
Land Rover (110) V8	Miniature Rocker Switch (183SA)	Hazard Warning Switch Rocker		3528	1985-90	<b>35367</b>
Land Rover (110) V8	Panel Switch	Hazard Warning		3528	1983-85	<b>39364</b>



MODEL	TYPE	FUNCTION	ENGINE INFO	CC	YEAR	PART NO.
<b>LAND ROVER CONTINUED</b>						
Land Rover (88) 2.25, Diesel	Toggle Switch 2 or 3 position (57SA)	3 Position Toggle Switch	4 Cyl	2286	1969-84	<b>31788</b>
Land Rover (88) 2.25, Diesel	Toggle Switch 2 ) position (65SA / 108SA)	2 Position Toggle Switch	4 Cyl	2286	1969-84	<b>34775</b>
Land Rover (88) 2.25, Diesel	Rotary Switch (145SA)	Rotary Wash Wipe Switch	4 Cyl		1972-84	<b>SQB967</b>
Land Rover (88) 2.25, Diesel	Toggle Switch 2 position (65SA / 108SA)	2 Position Toggle Switch	4 Cyl	2286	1975-84	<b>SPB200</b>
Land Rover (88) 2.25, Diesel	Miniature Rocker Switch (183SA)	Hazard Warning Switch Rocker	4 Cyl	2286	1984-85	<b>35367</b>
Land Rover (88) 2.25, Diesel	Panel Switch	Hazard Warning	4 Cyl	2286	1976-84	<b>39364</b>
Land Rover (90)	Miniature Rocker Switch (183SA)	Interior Light Switch			1985-90	<b>36642</b>
Land Rover (90) 2.5	Miniature Rocker Switch (183SA)	Hazard Warning Switch Rocker	4 Cyl	2495	1985-90	<b>35367</b>
Land Rover (90) 2.5 Diesel	Miniature Rocker Switch (183SA)	Hazard Warning Switch Rocker	4 Cyl 12J	2495	1985-90	<b>35367</b>
Land Rover (90) 2.5 Turbo Diesel	Miniature Rocker Switch (183SA)	Hazard Warning Switch Rocker	4 Cyl	2495	1986-90	<b>35367</b>
Land Rover (90) V8	Miniature Rocker Switch (183SA)	Hazard Warning Switch Rocker	V8	3528	1985-90	<b>35367</b>
Land Rover 90, 110, Defender	Panel Switch	Heated Rear Window Switch			1983-1990	<b>SQB705</b>
Land Rover Defender	Panel Switch				1983-94	<b>SQB713</b>
Land Rover Defender	Panel Switch	Hazard Warning Light Switch				<b>SQB710</b>
Land Rover Defender	Panel Switch	Heated Rear Window Switch				<b>SQB711</b>
Land Rover Defender	Panel Switch	Fog Light Switch				<b>SQB712</b>
Land Rover Defender 110 2.5	Miniature Rocker Switch (183SA)	Hazard Warning Switch Rocker	4 Cyl	2495	1990-92	<b>35367</b>
Land Rover Defender 110 2.5	Miniature Rocker Switch (183SA)	Electric Window Lift Switch Master	4 Cyl	2495	1990-92	<b>39980</b>
Land Rover Defender 110 2.5 D	Miniature Rocker Switch (183SA)	Hazard Warning Switch Rocker	4 Cyl	2495	1990-93	<b>35367</b>
Land Rover Defender 110 2.5 D	Miniature Rocker Switch (183SA)	Electric Window Lift Switch Master	4 Cyl	2495	1990-93	<b>39980</b>
Land Rover Defender 110 2.5 Tdi (300)	Miniature Rocker Switch (183SA)	Hazard Warning Switch Rocker	4 Cyl	2495	1994-98	<b>35367</b>
Land Rover Defender 110 2.5 Tdi (300)	Miniature Rocker Switch (183SA)	Electric Window Lift Switch Master	4 Cyl	2495	1994-98	<b>39980</b>
Land Rover Defender 110 V8	Miniature Rocker Switch (183SA)	Hazard Warning Switch Rocker		3528	1990-95	<b>35367</b>
Land Rover Defender 110 V8	Miniature Rocker Switch (183SA)	Electric Window Lift Switch Master		3528	1990-95	<b>39980</b>
Land Rover Defender 130 2.5 Tdi	Miniature Rocker Switch (183SA)	Hazard Warning Switch Rocker	4 Cyl	2495	1990-94	<b>35367</b>
Land Rover Defender 130 2.5 Tdi	Miniature Rocker Switch (183SA)	Electric Window Lift Switch Master	4 Cyl	2495	1990-94	<b>39980</b>
Land Rover Defender 130 V8	Miniature Rocker Switch (183SA)	Hazard Warning Switch Rocker		3528	1990-95	<b>35367</b>
Land Rover Defender 130 V8	Miniature Rocker Switch (183SA)	Electric Window Lift Switch Master		3528	1990-95	<b>39980</b>
Land Rover Defender 90 2.5, 90 2.5 D, Tdi	Miniature Rocker Switch (183SA)	Hazard Warning Switch Rocker	4 Cyl	2495	1990-94	<b>35367</b>
Land Rover Defender 90 2.5, 90 2.5 D, Tdi	Miniature Rocker Switch (183SA)	Electric Window Lift Switch Master	4 Cyl	2495	1990-94	<b>39980</b>
Land Rover Defender 90 V8	Miniature Rocker Switch (183SA)	Hazard Warning Switch Rocker	V8	3528	1990-95	<b>35367</b>
Land Rover Defender 90 V8	Miniature Rocker Switch (183SA)	Electric Window Lift Switch Master	V8	3528	1990-95	<b>39980</b>
Land Rover Defender	Panel Display	Warning Display Unit			05/90>>	<b>SQB715</b>
Land Rover Defender	Panel Display	Warning Display Unit			05/90>>	<b>SQB716</b>
Land Rover Defender	Panel Display	Warning Display Unit			05/90>>	<b>SQB717</b>
Land Rover Discovery	Rocker Switch	Electric Window Switch			12/94-11/98	<b>SPB220</b>
Land Rover Discovery	Switch	Reverse Light Switch			1995>>	<b>SPB219</b>
Range Rover 2.4 TD	Miniature Rocker Switch (183SA)	Light Switch		2393	04/86-90	<b>30713</b>
Range Rover 2.4 TD	Panel Switch	Lighting		2393	1989-90	<b>54034069</b>
Range Rover 2.5 TD	Panel Switch	Lighting	4 Cyl	2495	1989-92	<b>54034069</b>





MODEL	TYPE	FUNCTION	ENGINE INFO	CC	YEAR	PART NO.
<b>LAND ROVER CONTINUED</b>						
Range Rover 2.5 Tdi	Panel Switch	Lighting	4 Cyl	2495	1992-94	54034069
Range Rover 3.5	Rotary Switch (145SA)	Rotary Wash Wipe Switch			1972-85	SQB967
Range Rover 3.5	Miniature Rocker Switch (183SA)	Light Switch	V8	3528	1986-89	30713
Range Rover 3.5	Panel Switch	Hazard Warning		3528	1971-84	39364
Range Rover 3.5	Panel Switch	Lighting		3528	1989	54034069
Range Rover 3.5 EFI	Miniature Rocker Switch (183SA)	Light Switch	V8	3528	1986-89	30713
Range Rover 3.5 EFI	Panel Switch	Lighting	V8	3528	1989	54034069
Range Rover 3.9 V8i	Miniature Rocker Switch (183SA)	Light Switch	V8	3947	1989-94	30713
Range Rover 4.2 V8i	Miniature Rocker Switch (183SA)	Light Switch	V8	4278	1992-94	30713
Range Rover Classic	Rocker Switch	Electric Window Switch			1995>>	SPB220
Range Rover Classic	Switch	Reverse Light Switch			1995>>	SPB219
Range Rover Phase II	Panel Switch	Hazard Warning Light Switch			> 1986	SQB704
Range Rover Phase II	Panel Switch	Heater Blower Switch 4 position			1989-94	SQB706
Range Rover Phase II	Panel Switch	H Gate Cover Autotransmission (LHD)			1989-94	SQB714
<b>LDV</b>						
Sherpa (II) 200/City	Miniature Rocker Switch (183SA)	Hazard Warning Switch Rocker			1982-89	35367
Sherpa (II) 230	Miniature Rocker Switch (183SA)	Hazard Warning Switch Rocker			1982-89	35367
Sherpa (II) 250	Miniature Rocker Switch (183SA)	Hazard Warning Switch Rocker			1982-89	35367
Sherpa (II) 255	Miniature Rocker Switch (183SA)	Hazard Warning Switch Rocker			1982-89	35367
Sherpa (II) 280	Miniature Rocker Switch (183SA)	Hazard Warning Switch Rocker			1982-86	35367
Sherpa (II) 285	Miniature Rocker Switch (183SA)	Hazard Warning Switch Rocker			1983-89	35367
Sherpa (II) 310	Miniature Rocker Switch (183SA)	Hazard Warning Switch Rocker			1983-89	35367
Sherpa (II) 350	Miniature Rocker Switch (183SA)	Hazard Warning Switch Rocker			1985-89	35367
Sherpa 230	Miniature Rocker Switch (183SA)	Hazard Warning Switch Rocker			1982	35367
Sherpa 250	Miniature Rocker Switch (183SA)	Hazard Warning Switch Rocker			1982	35367
Sherpa 255	Miniature Rocker Switch (183SA)	Hazard Warning Switch Rocker			1982	35367
<b>LEYLAND DAF</b>						
FG 345 Truck (2.5), Diesel	Toggle Switch 2 or 3 position (57SA)	2 Position Toggle Switch		2520	1975-79	31780
FG 345 Truck (2.5), Diesel	Toggle Switch 2 or 3 position (57SA)	3 Position Toggle Switch		2520	1975-79	31788
FG 350 Truck (2.5)	Toggle Switch 2 or 3 position (57SA)	2 Position Toggle Switch		2520	1974-75	31780
FG 350 Truck (2.5) Diesel	Toggle Switch 2 or 3 position (57SA)	2 Position Toggle Switch		2520	1973-75	31780
FG 350 Truck (2.5) Diesel	Toggle Switch 2 or 3 position (57SA)	3 Position Toggle Switch		2520	1973-75	31788
FG 420 Truck (2.5)	Toggle Switch 2 or 3 position (57SA)	2 Position Toggle Switch		2520	1974-79	31780
FG 420 Truck (2.5)	Toggle Switch 2 or 3 position (57SA)	3 Position Toggle Switch		2520	1974-79	31788
FG 420 Truck (2.5) Diesel	Toggle Switch 2 or 3 position (57SA)	2 Position Toggle Switch		2520	1972-79	31780
FG 420 Truck (3.8) Diesel	Toggle Switch 2 or 3 position (57SA)	2 Position Toggle Switch		3770	1964-74	31780
FG 550 Truck (3.8) Diesel	Toggle Switch 2 or 3 position (57SA)	2 Position Toggle Switch		3770	1972-79	31780
J4 180 1500 Diesel, 1600	Pull/Push	Pull/Push Switch			1969-74	SPB104
J4 180 1500 Diesel, 1600	Pull/Push	Push			1969-74	SPB160



MODEL	TYPE	FUNCTION	ENGINE INFO	CC	YEAR	PART NO.
<b>LEYLAND DAF CONTINUED</b>						
J4 190 1500 Diesel, 1600	Pull/Push	Pull/Push Switch			1969-74	<b>SPB104</b>
J4 190 1500 Diesel, 1600	Pull/Push	Push			1969-74	<b>SPB160</b>
J4 200 1500 Diesel	Pull/Push	Pull/Push Switch		1489	1969-74	<b>SPB104</b>
J4 200 1500 Diesel	Pull/Push	Push		1489	1969-74	<b>SPB160</b>
J4 200 1600	Pull/Push	Pull/Push Switch		1622	1969-74	<b>SPB104</b>
J4 200 1600	Pull/Push	Push		1622	1969-74	<b>SPB160</b>
<b>LINER CONCRETE</b>						
Giraffe Forklift	Panel Switch	Horn/Dip	2711E	4150	1976 >>	<b>SPB140</b>
<b>LOTUS</b>						
Esprit S1 2.0 (Mk II)	Lever Switch (182SA)	Light Switch	907	1973	1978	<b>34224</b>
Esprit S2 2.0 (Mk II)	Lever Switch (182SA)	Light Switch		1973	1978-80	<b>34224</b>
Esprit S3 (Facelift) 2.2 SE	Lever Switch (182SA)	Window lift Switch		2174	1987-92	<b>33852</b>
Esprit S3 (Facelift) 2.2 Turbo	Lever Switch (182SA)	Window lift Switch		2174	1987-90	<b>33852</b>
Esprit S3 (Facelift) 2.2 Turbo S	Lever Switch (182SA)	Window lift Switch		2174	1990-91	<b>33852</b>
Esprit S3 (Facelift) 2.2 Turbo SE	Lever Switch (182SA)	Window lift Switch		2174	1989-92	<b>33852</b>
Esprit S3 2.2	Lever Switch (182SA)	Window lift Switch		2174	1980-87	<b>33852</b>
Esprit S3 2.2 SE	Lever Switch (182SA)	Window lift Switch		2174	1985-87	<b>33852</b>
Esprit S3 2.2 Turbo	Lever Switch (182SA)	Window lift Switch		2174	1983-87	<b>33852</b>
<b>LTI CARBODIES</b>						
FL2 Hire Car 2.25D	Toggle Switch 2 or 3 position (57SA)	2 Position Toggle Switch	4 Cyl 22E	2286	1972-85	<b>31780</b>
FL2 Hire Car 2.25D	Toggle Switch 2 or 3 position (57SA)	3 Position Toggle Switch	4 Cyl 22E	2286	1981-85	<b>35927</b>
FL2 Hire Car 2.25D	Panel Switch	Hazard Warning	4 Cyl 22E	2286	1978-85	<b>39976</b>
FX Fairway 2.7D	Miniature Rocker Switch (183SA)	Light Switch	TD 27	2663	1987 >>	<b>30713</b>
FX4 Taxi 2.25D	Toggle Switch 2 or 3 position (57SA)	2 Position Toggle Switch	4 Cyl 22E	2286	1972-85	<b>31780</b>
FX4 Taxi 2.25D	Toggle Switch 2 or 3 position (57SA)	3 Position Toggle Switch	4 Cyl 22E	2286	1972-85	<b>31788</b>
FX4 Taxi 2.25D	Toggle Switch 2 or 3 position (57SA)	3 Position Toggle Switch	4 Cyl 22E	2286	1981-85	<b>35927</b>
FX4 Taxi 2.25D	Panel Switch	Hazard Warning	4 Cyl 22E	2286	1978-85	<b>39976</b>
FX4R Taxi 2.25D	Toggle Switch 2 or 3 position (57SA)	2 Position Toggle Switch	4 Cyl 22E	2286	1982-85	<b>31780</b>
FX4R Taxi 2.25D	Toggle Switch 2 or 3 position (57SA)	3 Position Toggle Switch	4 Cyl 22E	2286	1982-85	<b>35927</b>
FX4R Taxi 2.25D	Panel Switch	Hazard Warning	4 Cyl 22E	2286	1982-85	<b>39976</b>
FX4S Taxi 2.5D	Miniature Rocker Switch (183SA)	Light Switch	4 Cyl 25V	2494	1986-89	<b>30713</b>
FX4S Taxi 2.5D	Toggle Switch 2 or 3 position (57SA)	2 Position Toggle Switch	4 Cyl 25V	2494	1986-89	<b>31780</b>
<b>MARSHALL TRACTORS</b>						
2100 Tractor	Rocker Switch (159SA)	Front Wiper Switch Two Speed		5655	1977-81	<b>39710</b>
2100 Tractor	Toggle Switch 2 or 3 position (57SA)	3 Position Toggle Switch		5655	1977-81	<b>31788</b>
245 Tractor (QM Cab)	Rocker Switch (159SA)	Front Wiper Switch Two Speed	Front	2500	1976-81	<b>39710</b>
245 Tractor (QM Cab)	Toggle Switch 2 or 3 position (57SA)	3 Position Toggle Switch		2500	1976-81	<b>31743</b>
245S Tractor	Toggle Switch 2 or 3 position (57SA)	3 Position Toggle Switch		2500	1976-81	<b>31743</b>
245S Tractor (QM Cab)	Rocker Switch (159SA)	Front Wiper Switch Two Speed	Front	2500	1976-81	<b>39710</b>
262 Tractor (QM Cab)	Rocker Switch (159SA)	Front Wiper Switch Two Speed		3770	1976-81	<b>39710</b>
262 Tractor (QM Cab)	Toggle Switch 2 or 3 position (57SA)	3 Position Toggle Switch		3770	1976-81	<b>31743</b>
262S Tractor (QM Cab)	Rocker Switch (159SA)	Front Wiper Switch Two Speed		3770	1977-81	<b>39710</b>
262S Tractor (QM Cab)	Toggle Switch 2 or 3 position (57SA)	3 Position Toggle Switch		3770	1977-81	<b>31743</b>
272 Tractor (QM Cab)	Rocker Switch (159SA)	Front Wiper Switch Two Speed		3770	1976-81	<b>39710</b>

PANEL SWITCHES – APPLICATION LIST



MODEL	TYPE	FUNCTION	ENGINE INFO	CC	YEAR	PART NO.
<b>MARSHALL TRACTORS CONTINUED</b>						
272 Tractor (QM Cab)	Toggle Switch 2 or 3 position (57SA)	3 Position Toggle Switch		3770	1976-81	31743
272S Tractor (QM Cab)	Rocker Switch (159SA)	Front Wiper Switch Two Speed		3770	1977-81	39710
272S Tractor (QM Cab)	Toggle Switch 2 or 3 position (57SA)	3 Position Toggle Switch		3770	1977-81	31743
285 Tractor	Rocker Switch (159SA)	Front Wiper Switch Two Speed		5655	1977-81	39710
285 Tractor	Toggle Switch 2 or 3 position (57SA)	3 Position Toggle Switch		5655	1977-81	31788
285-4 Tractor	Rocker Switch (159SA)	Front Wiper Switch Two Speed	4 Cyl		1977-81	39710
285-4 Tractor	Toggle Switch 2 or 3 position (57SA)	3 Position Toggle Switch	4 Cyl		1977-81	31788
4100 Tractor	Rocker Switch (159SA) Two Speed	Front Wiper Switch		5655	1977-81	39710
4100 Tractor	Toggle Switch 2 or 3 position (57SA)	3 Position Toggle Switch		5655	1977-81	31788
472S Tractor (QM Cab)	Rocker Switch (159SA)	Front Wiper Switch Two Speed		3770	1977-81	39710
472S Tractor (QM Cab)	Toggle Switch 2 or 3 position (57SA)	3 Position Toggle Switch		3770	1977-81	31743
485 Tractor	Rocker Switch (159SA)	Front Wiper Switch Two Speed		5655	1977-79	39710
485 Tractor	Toggle Switch 2 or 3 position (57SA)	3 Position Toggle Switch		5655	1977-79	31788
604 Tractor	Rocker Switch (159SA)	Front Wiper Switch Two Speed		3770	1980-85	39710
802 Tractor	Rocker Switch (159SA)	Front Wiper Switch Two Speed		3770	1981-85	39710
804 Tractor	Rocker Switch (159SA)	Front Wiper Switch Two Speed		3770	1980-85	39710
<b>MASSEY FERGUSON</b>						
MF 250.3, 250.4 Tractor	Rotary Switch (199SA)	Rotary Light Switch		2500	1982 >>	33714
MF 275 Tractor (Perkins 4.236)	Rotary Switch (199SA)	Rotary Light Switch			1979 >>	33714
MF 275 Tractor (Perkins 4.276)	Rotary Switch (199SA)	Rotary Light Switch		276cu	1979 >>	33714
MF 290 Tractor, Tractor 4WD	Rotary Switch (199SA)	Rotary Light Switch		3860	1980 >>	33714
MF 298 Tractor	Rotary Switch (199SA)	Rotary Light Switch		5210	1983-86	33714
MF 30 Backhoe-Loader	Rotary Switch (199SA)	Rotary Light Switch			1985-87	33714
MF 30 Drill	Rotary Switch (199SA)	Rotary Light Switch		2500	1984-87	33714
MF 30.3	Rotary Switch (199SA)	Rotary Light Switch		2500	1984 >>	33714
MF 30.4 (Perkins 4.203, 4212)	Rotary Switch (199SA)	Rotary Light Switch		3300	1984 >>	33714
MF 30-825	Rotary Switch (199SA)	Rotary Light Switch		107cu	1984 >>	33714
MF 30C Tractor	Rotary Switch (199SA)	Rotary Light Switch			1984 >>	33714
MF 30D Tractor	Rotary Switch (199SA)	Rotary Light Switch		3860	1984 >>	33714
MF 30E "Powershuttle" Tractor	Rotary Switch (199SA)	Rotary Light Switch		2500	1985 >>	33714
MF 30E Tractor	Rotary Switch (199SA)	Rotary Light Switch		2500	1984 >>	33714
MF 30H Backhoe-Loader	Rotary Switch (199SA)	Rotary Light Switch		2500	1984 >>	33714
MF 40.3, 40.4 Tractor	Pull/Push	Press Switch		2500	1970 >>	SPB105
MF 40B Excavator, Loader	Pull/Push	Press Switch			1970 >>	SPB105
MF 40B Tractor Industrial	Pull/Push	Press Switch		3860	1970 >>	SPB105
MF 40E Tractor	Pull/Push	Press Switch			1985 >>	SPB105
MF 40U Tractor	Pull/Push	Press Switch		2500	1970-81	SPB105
MF 50 Tractor (Perkins 4.203)	Pull/Push	Press Switch		3300	1973 >>	SPB105
MF 50 Tractor (Perkins 4.212)	Pull/Push	Press Switch		212cu	1973 >>	SPB105
MF 50 Tractor (Perkins 4.236)	Pull/Push	Press Switch		3860	1973-79	SPB105
MF 50 Tractor (Skid-Steer)	Pull/Push	Press Switch		212cu	1973 >>	SPB105
MF 50 Tractor Turbo	Pull/Push	Press Switch		212cu	1973 >>	SPB105
MF 50B Excavator, Loader	Pull/Push	Press Switch			1973 >>	SPB105
MF 50B Tractor (Perkins 4.212)	Pull/Push	Press Switch		212cu	1974 >>	SPB105
MF 50B Tractor (Perkins 4.236)	Pull/Push	Press Switch		3860	1973 >>	SPB105
MF 50B Tractor Industrial	Pull/Push	Press Switch			1973 >>	SPB105
MF 50C Tractor	Pull/Push	Press Switch		3860	1979 >>	SPB105
MF 50D Digger Loader	Pull/Push	Press Switch		3860	1982 >>	SPB105
MF 50EX Tractor	Pull/Push	Press Switch		4060	1973 >>	SPB105
MF 520 Combine	Pull/Push	Press Switch		5800	1971-79	SPB106
MF 525 Combine	Pull/Push	Press Switch		5800	1971 >>	SPB106
MF 525 Combine Turbo	Pull/Push	Press Switch		5800	1977 >>	SPB106



MODEL	TYPE	FUNCTION	ENGINE INFO	CC	YEAR	PART NO.
<b>MASSEY FERGUSON CONTINUED</b>						
MF 550.3 Tractor	Rocker Switch (159SA)	Front Wiper Switch Two Speed		2500	1976-81	<b>39710</b>
MF 550.3 Tractor	Pull/Push	Press Switch		2500	1976-81	<b>SPB105</b>
MF 550.3 Tractor	Rotary Switch (199SA)	Rotary Light Switch		2500	1977-81	<b>33714</b>
MF 550.6 Tractor	Rocker Switch (159SA)	Front Wiper Switch Two Speed		5800	1979-81	<b>39710</b>
MF 550.6 Tractor	Rotary Switch (199SA)	Rotary Light Switch		5800	1979-81	<b>33714</b>
MF 550.6 Tractor	Pull/Push	Press Switch		5800	1979-81	<b>SPB105</b>
MF 565 Combine, 575 Tractor, 590 Combine	Rocker Switch (159SA)	Front Wiper Switch Two Speed			1976-81	<b>39710</b>
MF 565 Combine, 575 Tractor, 590 Combine	Rotary Switch (199SA)	Rotary Light Switch			1976-81	<b>33714</b>
MF 565 Combine, 575 Tractor, 590 Combine	Pull/Push	Press Switch			1976-81	<b>SPB105</b>
MF 620 Tractor, 625 Tractor	Pull/Push	Press Switch		372cu	1971 >>	<b>SPB106</b>
<b>MISCELLANEOUS</b>						
	Switch	Fan Switch				<b>SPB311</b>
<b>MORGAN</b>						
Four Four 1600	Toggle Switch 2 or 3 position (57SA)	2 Position Toggle Switch	OHV	1599	1969-82	<b>31780</b>
Four Four 1600	Toggle Switch 2 or 3 position (57SA)	2 Position Toggle Switch	CVH	1596	1982-85	<b>31780</b>
Four Four 1600 TC	Toggle Switch 2 or 3 position (57SA)	2 Position Toggle Switch	OHV	1599	1982-85	<b>31780</b>
<b>MUIR-HILL</b>						
A4000 Loading Shovel	Toggle Switch 2 or 3 position (57SA)	2 Position Toggle Switch		4150	1970 >>	<b>31780</b>
A4000 Loading Shovel	Toggle Switch 2 or 3 position (57SA)	3 Position Toggle Switch		4150	1970 >>	<b>31788</b>
A4000 Loading Shovel	Toggle Switch 2 position (65SA / 108SA)	2 Position Toggle Switch		4150	1970 >>	<b>SPB203</b>
A4000 Loading Shovel	Pull/Push	Push		4150	1971 >>	<b>SPB160</b>
A5000 Loading Shovel	Toggle Switch 2 or 3 position (57SA)	2 Position Toggle Switch			1970 >>	<b>31780</b>
A5000 Loading Shovel	Toggle Switch 2 or 3 position (57SA)	3 Position Toggle Switch			1970 >>	<b>31788</b>
A5000 Loading Shovel	Toggle Switch 2 position (65SA / 108SA)	2 Position Toggle Switch			1970 >>	<b>SPB203</b>
A5000 Loading Shovel	Pull/Push	Push			1971 >>	<b>SPB160</b>
B4000 Loading Shovel	Toggle Switch 2 or 3 position (57SA)	2 Position Toggle Switch			1970 >>	<b>31780</b>
B4000 Loading Shovel	Toggle Switch 2 or 3 position (57SA)	3 Position Toggle Switch			1970 >>	<b>31788</b>
B4000 Loading Shovel	Toggle Switch 2 position (65SA / 108SA)	2 Position Toggle Switch			1970 >>	<b>SPB203</b>
B4000 Loading Shovel	Pull/Push	Push			1970 >>	<b>SPB160</b>
B5000 Loading Shovel	Toggle Switch 2 or 3 position (57SA)	2 Position Toggle Switch		6220	1970 >>	<b>31780</b>
B5000 Loading Shovel	Toggle Switch 2 or 3 position (57SA)	3 Position Toggle Switch		6220	1970 >>	<b>31788</b>
B5000 Loading Shovel	Toggle Switch 2 position (65SA / 108SA)	2 Position Toggle Switch		6220	1970 >>	<b>SPB203</b>
B5000 Loading Shovel	Pull/Push	Push		6220	1971 >>	<b>SPB160</b>
F4000 Loading Shovel	Toggle Switch 2 or 3 position (57SA)	2 Position Toggle Switch		3860	1970 >>	<b>31780</b>
F4000 Loading Shovel	Toggle Switch 2 or 3 position (57SA)	3 Position Toggle Switch		3860	1970 >>	<b>31788</b>
F4000 Loading Shovel	Toggle Switch 2 position (65SA / 108SA)	2 Position Toggle Switch		3860	1970 >>	<b>SPB203</b>
F4000 Loading Shovel	Pull/Push	Push		3860	1970 >>	<b>SPB160</b>
F5000 Loading Shovel	Toggle Switch 2 or 3 position (57SA)	2 Position Toggle Switch		5800	1970 >>	<b>31780</b>
F5000 Loading Shovel	Toggle Switch 2 or 3 position (57SA)	3 Position Toggle Switch		5800	1970 >>	<b>31788</b>
F5000 Loading Shovel	Toggle Switch 2 position (65SA / 108SA)	2 Position Toggle Switch		5800	1970 >>	<b>SPB203</b>
F5000 Loading Shovel	Pull/Push	Push		5800	1970 >>	<b>SPB160</b>
M-H 111 Tractor	Toggle Switch 2 or 3 position (57SA)	2 Position Toggle Switch		5800	1973	<b>31780</b>

PANEL SWITCHES – APPLICATION LIST



MODEL	TYPE	FUNCTION	ENGINE INFO	CC	YEAR	PART NO.
<b>MUIR-HILL CONTINUED</b>						
M-H 111 Tractor 4WD	Toggle Switch 2 or 3 position (57SA)	2 Position Toggle Switch		5800	1978-82	<b>31780</b>
M-H 111 Tractor 4WD	Pull/Push	Press Switch		5800	1978-82	<b>SPB105</b>
M-H 121 Tractor 4WD	Pull/Push	Press Switch		6220	1978-82	<b>SPB105</b>
<b>RELIANT</b>						
Fox	Rocker Switch (159SA)	Light Switch	OHV	848	1983-90	<b>30731</b>
Rialto 850, Van	Rocker Switch (159SA)	Light Switch	OHV	848	1982-95	<b>30731</b>
Robin	Toggle Switch 2 position (65SA / 108SA)	2 Position Toggle Switch			1973-81	<b>34889</b>
TW9B, C Mighty Ant	Toggle Switch 2 or 3 position (57SA)	3 Position Toggle Switch		1493	1969-73	<b>31788</b>
TW9B, C Mighty Ant	Toggle Switch 2 position (65SA / 108SA)	2 Position Toggle Switch		1493	1969-73	<b>SPB200</b>
TW9E Mighty Ant	Toggle Switch 2 or 3 position (57SA)	3 Position Toggle Switch		748	1969-81	<b>31788</b>
TW9E Mighty Ant	Toggle Switch 2 position (65SA / 108SA)	2 Position Toggle Switch		748	1969-81	<b>SPB200</b>
<b>RENAULT</b>						
	Switch	Overdrive Switch				<b>SPB325</b>
<b>ROVER</b>						
25	Switch	Sunroof Switch Rocker	36744A		10/99-04/05	<b>SPB229</b>
25	Switch	Electric Window Switch Front	53847A0A		10/99-04/05	<b>SPB231</b>
25	Switch	Electric Window Switch Front	53846A0A		10/99-04/05	<b>SPB232</b>
25	Switch	Electric Window Switch Rear	50780A0A		10/99-04/05	<b>SPB233</b>
25	Switch	Electric Window Switch Cluster	53855A0A		10/99-04/05	<b>SPB247</b>
25	Switch	Air Con Switch	51868A0B		10/99-04/05	<b>SPB253</b>
25	Switch	Heated Rear Window Switch	51401A0E		10/99-04/05	<b>SPB254</b>
25	Switch	Heated Seat Switch	51870A0B		10/99-04/05	<b>SPB255</b>
25	Switch	Rear Fog Light Switch	51399A0E		10/99-04/05	<b>SPB256</b>
25	Switch	Electric Window Isolator Switch	53835A0C		10/99-04/05	<b>SPB258</b>
25	Switch	Head Light Level Switch	51558A0C		10/99-04/05	<b>SPB262</b>
25	Switch	Head Light Level Switch	37212		10/99-04/05	<b>SPB263</b>
25	Switch	Switch Position Blank	5184500B		10/99-04/05	<b>SPB264</b>
25	Switch Component	Sunroof Switch Surround	54034451		10/99-04/05	<b>SPC100</b>
45	Switch	Electric Window Switch Single	201232001B		02/00-04/05	<b>SPB223</b>
45	Switch	Electric Window Switch Double	53692A0B		02/00-04/05	<b>SPB224</b>
45	Switch	Electric Window Switch & Isolator	53690A0A		02/00-04/05	<b>SPB225</b>
45	Switch	Sunroof Switch	54034423		02/00-04/05	<b>SPB226</b>
45	Switch	Sunroof Switch	54034424		02/00-04/05	<b>SPB227</b>
45	Switch	Gearbox Snow Mode Switch	53696A0C		02/00-04/05	<b>SPB230</b>
45	Switch	Electric Window Switch	50780A0A		02/00-04/05	<b>SPB233</b>
45	Switch	Hazard Light Switch	50385A0B		02/00-04/05	<b>SPB234</b>
45	Switch	Heated Rear Window Switch	51201A0B		02/00-04/05	<b>SPB245</b>
45	Switch	Electric Mirror Adjustment Switch	6737001A		02/00-04/05	<b>SPB248</b>
45	Switch	Headlight Adjustment Switch	37172A		02/00-04/05	<b>SPB260</b>
45	Switch	Head Light Level Switch	50404A0G		02/00-04/05	<b>SPB261</b>
45	Switch	Switch Position Blank	5184500B		02/00-04/05	<b>SPB264</b>
75	Switch	Seat Position Memory Switch	53268A0A		10/99-04/05	<b>SPB235</b>
75	Switch	Boot Release Switch LH	53631A0D		10/99-04/05	<b>SPB236</b>
75	Switch	Boot Release Switch RH	52550A0D		10/99-04/05	<b>SPB237</b>
75	Switch	Master Central Locking Switch	52547A0C		10/99-04/05	<b>SPB238</b>
75	Switch	Cruise Control Switch	52549A0C		10/99-04/05	<b>SPB239</b>



MODEL	TYPE	FUNCTION	ENGINE INFO	CC	YEAR	PART NO.
<b>ROVER CONTINUED</b>						
75	Switch	Door Lock Switch	301063001B		10/99-04/05	SPB240
75	Switch	Hazard Light Switch	52546A0D		10/99-04/05	SPB241
75	Switch	Rear Sunblind Switch	52545A0C		10/99-04/05	SPB242
75	Switch	Heated Seat Switch	52544A0C		10/99-04/05	SPB243
75	Switch	Traction Control Switch	52548A0E		10/99-04/05	SPB244
75	Switch	Transmission Mode Switch	36966A		10/99-04/05	SPB265
45, 400	Switch	Courtesy Light Switch			02/00-05/05	SPB222
Allegro 2 1100, 1300, 1500, 1750	Rocker Switch (159SA)	Light Switch			1975-79	30731
Allegro 3 1.0, 1.1, 1.3, 1.5, 1.7	Panel Switch	Heater			1979-83	54033632
Maxi 1500, 1750	Rocker Switch (159SA)	Front Wiper Switch Twin Speed		1485	1972-78	39748
Maxi 1500, 1750	Rocker Switch (159SA)	Rocker Washer Switch		1485	1973-78	30365
MG Midget 1500	Rocker Switch (159SA)	Light Switch	4 Cyl OHV	1491	1975-77	39914
MG Midget 1500	Rocker Switch (159SA)	Heater Fan Switch Single Speed	{US} 4 Cyl OHV	1491	1975-77	39915
MG Midget 1500	Rocker Switch (159SA)	Light Switch	4 Cyl OHV	1491	1975-80	39737
MG Midget 1500	Rocker Switch (159SA)	Front Wiper Switch Two Speed	4 Cyl OHV	1491	1979-80	39736
MGB	Rocker Switch (159SA)	Light Switch		1798	1972-76	39737
MGB	Rocker Switch (159SA)	Light Switch		1798	1973-76	39914
MGB	Rocker Switch (159SA)	Heater Fan Switch Single Speed	{US}	1798	1974-76	39915
MGB	Miniature Rocker Switch (183SA)	Light Switch		1798	1977-81	30924
MGB	Miniature Rocker Switch (183SA)	Fan Switch Twin Speed		1798	1977-81	30926
MGB	Miniature Rocker Switch (183SA)	Hazard Warning Switch Rocker		1798	1977-81	30928
MGB	Miniature Rocker Switch (183SA)	Light Switch		1798	1977-81	30949
MGB GT	Rheostat			1798	1969-79	78405
MGB GT	Rocker Switch (159SA)	Light Switch		1798	1972-76	39737
MGB GT	Rocker Switch (159SA)	Light Switch		1798	1973-76	39914
MGB GT	Rocker Switch (159SA)	Heater Fan Switch Single Speed	{US}	1798	1974-76	39915
MGB GT	Miniature Rocker Switch (183SA)	Light Switch		1798	1977-81	30924
MGB GT	Miniature Rocker Switch (183SA)	Fan Switch Twin Speed		1798	1977-81	30926
MGB GT	Miniature Rocker Switch (183SA)	Hazard Warning Switch Rocker		1798	1977-81	30928
MGB GT	Miniature Rocker Switch (183SA)	Light Switch		1798	1977-81	30949
MGB GT V8	Rocker Switch (159SA)	Light Switch		3528	1975-76	39737
MGTF	Switch	Hazard Light Switch	51846A0A		03/02-04/05	SPB257
MGTF	Switch	Panel Dimmer Switch	00827A0K		03/02-04/05	SPB259
MGTF	Switch	Switch Position Blank	5184500B		03/02-04/05	SPB264
MGTF	Switch	Gear Change Switch	53800A0B		03/02-04/05	SPB266
MGTF	Rocker Switch	Electric Window Switch			03/95-03/02	SPB221
Mini 1/4 Ton Van	Miniature Rocker Switch (183SA)	Light Switch			1976-80	30935
Mini 1000	Rocker Switch (159SA)	Light Switch		998	1971-76	39314
Mini 1000	Rocker Switch (159SA)	Front Wiper Switch Single Speed		998	1971-76	39315
Mini 1000	Miniature Rocker Switch (183SA)	Hazard Warning Switch Rocker		998	1975-92	30771
Mini 1000	Miniature Rocker Switch (183SA)	Light Switch		998	1976-80	30935
Mini 1100	Rocker Switch (159SA)	Light Switch		1098	1976	39314
Mini 1100	Miniature Rocker Switch (183SA)	Light Switch		1098	1976-80	30935
Mini 1100	Miniature Rocker Switch (183SA)	Hazard Warning Switch Rocker		1098	1976-81	30771
Mini 850	Rocker Switch (159SA)	Light Switch		848	1971-76	39314
Mini 850	Rocker Switch (159SA)	Front Wiper Switch Single Speed		848	1971-76	39315
Mini 850	Miniature Rocker Switch (183SA)	Hazard Warning Switch Rocker		848	1975-80	30771

PANEL SWITCHES – APPLICATION LIST



MODEL	TYPE	FUNCTION	ENGINE INFO	CC	YEAR	PART NO.
<b>ROVER CONTINUED</b>						
Mini 850	Miniature Rocker Switch (183SA)	Light Switch		848	1976-80	30935
Mini 95 Van	Miniature Rocker Switch (183SA)	Light Switch		998	1980	30935
Mini 95 Van	Miniature Rocker Switch (183SA)	Hazard Warning Switch Rocker		998	1980-83	30771
Mini Clubman 1000	Rocker Switch (159SA)	Light Switch		998	1971-76	39314
Mini Clubman 1000	Rocker Switch (159SA)	Front Wiper Switch Single Speed		998	1971-76	39315
Mini Clubman 1000	Miniature Rocker Switch (183SA)	Hazard Warning Switch Rocker		998	1976-80	30771
Mini Clubman 1000	Miniature Rocker Switch (183SA)	Light Switch		998	1976-80	30935
Mini Clubman 1100	Rocker Switch (159SA)	Light Switch		1098	1976	39314
Mini Clubman 1100	Rocker Switch (159SA)	Front Wiper Switch Single Speed		1098	1976	39315
Mini Clubman 1100	Miniature Rocker Switch (183SA)	Hazard Warning Switch Rocker		1098	1975-80	30771
Mini Clubman 1100	Miniature Rocker Switch (183SA)	Light Switch		1098	1976-80	30935
Mini Clubman 1275 GT	Rocker Switch (159SA)	Light Switch		1275	1971-76	39314
Mini Clubman 1275 GT	Rocker Switch (159SA)	Front Wiper Switch Single Speed		1275	1971-76	39315
Mini Clubman 1275 GT	Miniature Rocker Switch (183SA)	Hazard Warning Switch Rocker		1275	1976-80	30771
Mini Clubman 1275 GT	Miniature Rocker Switch (183SA)	Light Switch		1275	1976-80	30935
Mini Cooper S	Rocker Switch (159SA)	Light Switch		1275	1971	39314
Mini Cooper S	Rocker Switch (159SA)	Front Wiper Switch Single Speed		1275	1971	39315
Mini Pick-Up 850, 1000	Miniature Rocker Switch (183SA)	Light Switch			1976-80	30935
Mini Pick-Up 850, 1000	Miniature Rocker Switch (183SA)	Hazard Warning Switch Rocker			1980-83	30771
Rover (SD1) 2000	Miniature Rocker Switch (183SA)	Light Switch		1994	1982-86	30713
Rover (SD1) 2300	Miniature Rocker Switch (183SA)	Light Switch		2350	1977-87	30713
Rover (SD1) 2400 SD Turbo	Miniature Rocker Switch (183SA)	Light Switch		2393	1982-86	30713
Rover (SD1) 2600	Miniature Rocker Switch (183SA)	Light Switch		2597	1977-87	30713
Rover (SD1) 3500 EFI	Miniature Rocker Switch (183SA)	Light Switch	V8	3528	1984-86	30713
Rover (SD1) 3500 V8	Miniature Rocker Switch (183SA)	Light Switch		3528	1976-86	30713
Rover (SD1) Vitesse	Miniature Rocker Switch (183SA)	Light Switch	V8	3528	1982-86	30713
Triumph Dolomite 1300, 1500, 1850 HL	Panel Switch	Hazard Warning	4 Cyl OHV		1976-81	39976
Triumph Dolomite 1300, 1500, 1850 HL	Panel Switch	Heater	4 Cyl OHV		1976-81	54033632
Triumph Dolomite Sprint 16v	Panel Switch	Hazard Warning	4 Cyl OHC	1998	1975-81	39976
Triumph Dolomite Sprint 16v	Panel Switch	Heater	4 Cyl OHC	1998	1973-81	54033632
Triumph Spitfire 1500	Rocker Switch (159SA)	Light Switch		1493	1976-81	30731
Triumph Spitfire 1500	Panel Switch	Hazard Warning		1493	1976	39976
Triumph Stag	Panel Switch	Hazard Warning		2997	1973-77	39976
Triumph TR6 PI (125 bhp)	Panel Switch	Hazard Warning		2498	1973-75	39976
Triumph TR7 FH Coupe, Sprint 16v	Lever Switch (182SA)	Light Switch		1998	1977-82	34224
Triumph TR8 DH Coupe	Lever Switch (182SA)	Light Switch	V8	3528	1979-82	34224
<b>RVI (RTI)</b>						
Commando (100) II G08 Z3, Z4 7.38 Ton	Pull/Push	Press Switch		5800	1981-89	SPB106
Commando (100) II G08 Z3, Z4 7.38 Ton	Rocker Switch (159SA)	Rear Fog Light Switch		5800	1982-89	34245
Commando (100) II G09 Z3, Z4 8.5 Ton	Pull/Push	Press Switch		5800	1981-86	SPB106
Commando (100) II G09 Z3, Z4 8.5 Ton	Rocker Switch (159SA)	Rear Fog Light Switch		5800	1982-86	34245
Commando (100) II G10 Z3, Z4 9.7 Ton	Pull/Push	Press Switch		5800	1981-89	SPB106
Commando (100) II G10 Z3, Z4 9.7 Ton	Rocker Switch (159SA)	Rear Fog Light Switch		5800	1982-89	34245
Commando (100) II G11 Z3, Z4 11.2 Ton	Pull/Push	Press Switch		5800	1981-89	SPB106
Commando (100) II G11 Z3, Z4 11.2 Ton	Rocker Switch (159SA)	Rear Fog Light Switch		5800	1982-89	34245
Commando (100) II G11 Z6 11.2 Ton	Rocker Switch (159SA)	Rear Fog Light Switch		5800	1982-89	34245



MODEL	TYPE	FUNCTION	ENGINE INFO	CC	YEAR	PART NO.
<b>RVI (RTI) CONTINUED</b>						
Commando (100) II G11 Z6 11.2 Ton	Pull/Push	Press Switch		5800	1982-89	SPB106
Commando (100) II G12 Z3 12.0 Ton	Pull/Push	Press Switch		5800	1981-89	SPB106
Commando (100) II G12 Z3 12.0 Ton	Rocker Switch (159SA)	Rear Fog Light Switch		5800	1982-89	34245
Commando (100) II G12 Z4 12.0 Ton	Rocker Switch (159SA)	Rear Fog Light Switch		5800	1982-89	34245
Commando (100) II G12 Z4 12.0 Ton	Pull/Push	Press Switch		5800	1982-89	SPB106
Commando (100) II G12 Z6 12.0 Ton	Pull/Push	Press Switch		5800	1981-89	SPB106
Commando (100) II G12 Z6 12.0 Ton	Rocker Switch (159SA)	Rear Fog Light Switch		5800	1982-89	34245
Commando (100) II G13 V5 13.0 Ton	Pull/Push	Press Switch	V8	8830	1981-89	SPB106
Commando (100) II G13 V5 13.0 Ton	Rocker Switch (159SA)	Rear Fog Light Switch	V8	8830	1982-89	34245
Commando (100) II G13 Z3, Z6 13.0 Ton	Pull/Push	Press Switch		5800	1981-89	SPB106
Commando (100) II G13 Z3, Z6 13.0 Ton	Rocker Switch (159SA)	Rear Fog Light Switch		5800	1982-89	34245
Commando (100) II G15 V5 14.5 Ton	Rocker Switch (159SA)	Rear Fog Light Switch	V8	8830	1982-86	34245
Commando (100) II G15 V5 14.5 Ton	Pull/Push	Press Switch	V8	8830	1982-86	SPB106
Commando (100) II G15 Z3, Z6 14.5 Ton	Pull/Push	Press Switch		5800	1981-86	SPB106
Commando (100) II G15 Z3, Z6 14.5 Ton	Rocker Switch (159SA)	Rear Fog Light Switch		5800	1982-86	34245
Commando (100) II G16 V5 16.0 Ton	Pull/Push	Press Switch	V8	8830	1981-88	SPB106
Commando (100) II G16 V5 16.0 Ton	Rocker Switch (159SA)	Rear Fog Light Switch	V8	8830	1982-88	34245
Commando (100) II G16 V7 16.0 Ton	Rocker Switch (159SA)	Rear Fog Light Switch	TV8	8830	1984-88	34245
Commando (100) II G16 V7 16.0 Ton	Pull/Push	Press Switch	TV8	8830	1984-88	SPB106
Commando (100) II G16 Z3, Z6 16.0 Ton	Pull/Push	Press Switch		5800	1981-88	SPB106
Commando (100) II G16 Z3, Z6 16.0 Ton	Rocker Switch (159SA)	Rear Fog Light Switch		5800	1982-88	34245
Commando (100) II G17 V5, V7 17.0 Ton	Rocker Switch (159SA)	Rear Fog Light Switch	V8	8830	1988-89	34245
Commando (100) II G17 V5, V7 17.0 Ton	Pull/Push	Press Switch	V8	8830	1988-89	SPB106
Commando (100) II G17 Z3, Z6 17.0 Ton	Rocker Switch (159SA)	Rear Fog Light Switch		5800	1988-89	34245
Commando (100) II G17 Z3, Z6 17.0 Ton	Pull/Push	Press Switch		5800	1988-89	SPB106
Commando (100) II G18 Z6 18.0 Ton Tractor Unit	Rocker Switch (159SA)	Rear Fog Light Switch		5800	1982-86	34245
Commando (100) II G18 Z6 18.0 Ton Tractor Unit	Pull/Push	Press Switch		5800	1982-86	SPB106
Commando (100) II G20 Z6 20.0 Ton Tractor Unit	Rocker Switch (159SA)	Rear Fog Light Switch		5800	1982-89	34245
Commando (100) II G20 Z6 20.0 Ton Tractor Unit	Pull/Push	Press Switch		5800	1981-89	SPB106
Commando (100) II G26, V5 26.0 Ton Tractor Unit	Pull/Push	Press Switch		8830	1981-89	SPB106
Commando (100) II G26, V5 26.0 Ton Tractor Unit	Rocker Switch (159SA)	Rear Fog Light Switch		8830	1982-89	34245
<b>SEDDON ATKINSON</b>						
200 (R16N358) Series	Panel Switch	Hazard Warning		5870	1976-82	35476
201 (R17N13) Series	Panel Switch	Hazard Warning		5870	1982-85	35476
201 (R17P16) Series	Panel Switch	Hazard Warning		5870	1983-86	35476
210 (C17) 4x2 Rigid (Cummins 6BTAA 210)	Panel Switch	Hazard Warning		5880	1993 >>	35476
300 (R24M466) 6x4 Rigid	Panel Switch	Hazard Warning		7640	1978-82	35476
301 (R24L22) 6x4 Rigid (Cummins LT10-220)	Panel Switch	Hazard Warning		10013	1983-87	35476
301 (R24M466) 6x4 Rigid	Panel Switch	Hazard Warning		7640	1982-85	35476
301 (R30L25) 8x4 Rigid (Cummins LT10-250)	Panel Switch	Hazard Warning		10013	1985-87	35476
301 (T17L25) 4x2 Tractor Unit (Cummins LT10-250)	Panel Switch	Hazard Warning		10013	1985-87	35476
301 (T17L29) 4x2 Tractor Unit (Cummins LTA10-290)	Panel Switch	Hazard Warning		10013	1984-87	35476
301 (T22L29) 6x2 Tractor Unit (Cummins LTA10-290)	Panel Switch	Hazard Warning		10013	1984-87	35476
301 (T24L29) 6x4 Tractor Unit (Cummins LTA10-290)	Panel Switch	Hazard Warning		10013	1984-87	35476
400 (R30G6XC) 8x4 Rigid	Panel Switch	Hazard Warning		10450	1978-80	35476
400 (T30G6XB, T32G6XC) 8x4 Series	Panel Switch	Hazard Warning		10450	1976-78	35476
400 (T34R220) 8x4 Series	Panel Switch	Hazard Warning		12170	1976-78	35476
400 (T36C250) 8x4 Series	Panel Switch	Hazard Warning		14000	1976-80	35476
400 (T36C250T) 8x4 Series	Panel Switch	Hazard Warning		14000	1979-80	35476
400 (T36R265), (T36G8XB) 8x4 Series	Panel Switch	Hazard Warning		12170	1976-80	35476
400 (T38C290) 8x4 Series	Panel Switch	Hazard Warning		14000	1976-80	35476
400 (T38R280) 8x4 Series	Panel Switch	Hazard Warning		12170	1976	35476
400 (T38R290) 8x4 Series	Panel Switch	Hazard Warning		12170	1976-80	35476
<b>TVR</b>						
Taima	Rocker Switch (159SA)	Light Switch		2994	1976-77	39914
Taimar Turbo	Rocker Switch (159SA)	Light Switch		2994	1976-77	39914
Tasmin 2.8i	Lever Switch (182SA)	Window lift Switch		2792	1980-83	33852
<b>VAUXHALL</b>						
All Models	Accessories	5 pin switch fitted to the rear of the steering lock				SPB108





MODEL	TYPE	FUNCTION	ENGINE INFO	CC	YEAR	PART NO.
<b>VOLVO LEYLAND (AEC)</b>						
Atlantean	Panel Switch	Horn/Dip			1969-83	SPB140
National II	Toggle Switch 2 or 3 position (57SA)	2 Position Toggle Switch			1973-78	31780
Olympian	Panel Switch	Horn/Dip		9783	1970-76	SPB140
Royal Tiger	Panel Switch	Horn/Dip			1969-76	SPB140
Titan (Leyland TL11)	Toggle Switch 2 or 3 position (57SA)	2 Position Toggle Switch			1979	31780
Titan (Leyland TL11)	Panel Switch	Heater			1979	54033632
Victory (Gardner 6LX) (Leyland 680)	Pull/Push	Push			1970-73	SPB160
Victory J (Gardner 6LX)	Pull/Push	Push		10450	1970-73	SPB160
Victory, J (Gardner 6LXB)	Pull/Push	Push		10450	1974-77	SPB160
Worldmaster	Panel Switch	Horn/Dip			1969-78	SPB140













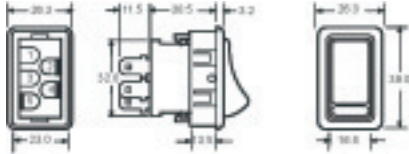



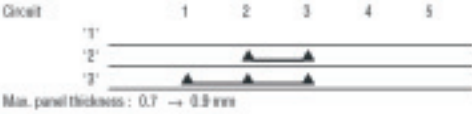

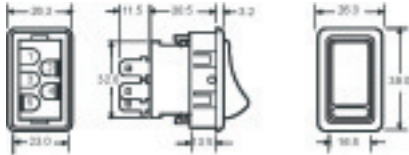



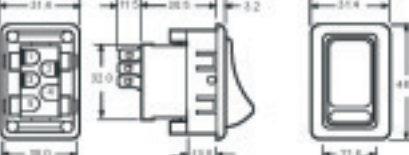

PART NO.	DESCRIPTION	FUNCTION		FINISH		PICTURE		DIAGRAM	
		ILLUMINATION	CONTACT	VOLTAGE	PIERCING	TERMINATION	PANEL SYMBOL	CIRCUIT	

Current Ratings						
1595A	12v	24v	1895A	12v	575A	12v 24v
Resistive Load	17.5A	8A	Resistive Load	20A	Resistive Load	10A 4A
Inductive Load	5A	3A	Inductive Load	7A	Inductive Load	5A 2A
34775, 34889	12v	24v	5PB200, 203, 204	12v	1825A	12v
Resistive Load	18A	8A	Resistive Load	5A	Resistive Load	20a
Inductive Load	5A	2A	Inductive Load	2.5A		

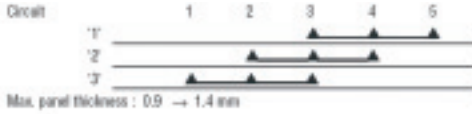
**159SA**

30365	Rocker Switch (159SA)	WASH	METALLISED				Max. panel thickness: 1.1 → 1.4 mm
			12v / 24v				
30731	Rocker Switch (159SA)	LIGHTING	BLACK				Max. panel thickness: 1.1 → 1.4 mm
			12v / 24v				
34245	Rocker Switch (159SA)	FOG	BLACK				Max. panel thickness: 2.0 → 2.5 mm
			12v / 24v				

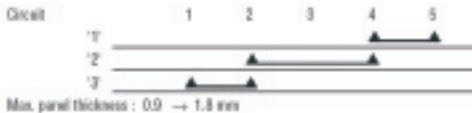

PART NO.	DESCRIPTION	FUNCTION	FINISH	PICTURE		DIAGRAM
		ILLUMINATION CONTACT	VOLTAGE PIERCING	TERMINATION	PANEL SYMBOL	CIRCUIT
<b>159SA CONTINUED</b>						
39314	Rocker Switch (159SA)	LIGHTING	BLACK			
			12v / 24v			
						
39315	Rocker Switch (159SA)	WIPER	BLACK			
			12v / 24v			
						
39710	Rocker Switch (159SA)	WIPER	BLACK			
			12v / 24v			
						
39736	Rocker Switch (159SA)	WIPER	BLACK			
			12v / 24v			
						

PANEL SWITCHES – PRODUCT SPECIFICATION



PART NO.	DESCRIPTION	FUNCTION	FINISH	PICTURE		DIAGRAM
		ILLUMINATION	VOLTAGE	TERMINATION	PANEL SYMBOL	CIRCUIT
159SA CONTINUED						
39737	Rocker Switch (159SA)	LIGHTING	BLACK			
			12v / 24v			
39748	Rocker Switch (159SA)	WIPER	METALLISED			
			12v			
39914	Rocker Switch (159SA)	LIGHTING	METALLISED			
			12v / 24v			
39915	Rocker Switch (159SA)	FAN	METALLISED			
			12v / 24v			



PART NO.	DESCRIPTION	FUNCTION	FINISH	PICTURE		DIAGRAM
		ILLUMINATION	VOLTAGE	TERMINATION	PANEL SYMBOL	CIRCUIT
183SA						
30713	Miniature Rocker Switch (183SA)	LIGHTING	BLACK			
			12v			
30771	Miniature Rocker Switch (183SA)	HAZARD	BLACK			
		GREEN	12v			
30924	Miniature Rocker Switch (183SA)	LIGHTING	BLACK			
			12v			
30926	Miniature Rocker Switch (183SA)	FAN	BLACK			
		GREEN	12v			

PANEL SWITCHES – PRODUCT SPECIFICATION



PART NO.	DESCRIPTION	FUNCTION	FINISH	PICTURE		DIAGRAM
		ILLUMINATION	VOLTAGE	TERMINATION	PANEL SYMBOL	CIRCUIT
183SA CONTINUED						
30928	Miniature Rocker Switch (183SA)	HAZARD	BLACK			
		GREEN	12v			
						<p>Circuit</p> <p>Max. panel thickness : 4.2 → 4.6 mm</p>
30935	Miniature Rocker Switch (183SA)	LIGHTING	BLACK			
			12v			
						<p>Circuit</p> <p>Max. panel thickness : 0.6 → 0.8 mm</p>
30949	Miniature Rocker Switch (183SA)	LIGHTING	BLACK			
			12v			
						<p>Circuit</p> <p>Max. panel thickness : 2.4 → 2.6 mm</p>
35283	Panel Switch (183SA)	INTERIOR LIGHT	BLACK			
			12v			
						<p>Circuit</p> <p>Max. panel thickness : 1.2 → 1.5 mm</p>

PANEL SWITCHES – PRODUCT SPECIFICATION



PART NO.	DESCRIPTION	FUNCTION	FINISH	PICTURE		DIAGRAM
		ILLUMINATION	VOLTAGE	TERMINATION	PANEL SYMBOL	CIRCUIT
183SA CONTINUED						
35367	Miniature Rocker Switch (183SA)					
36642	Miniature Rocker Switch (183SA)	INTERIOR LIGHT	BLACK			
			12v			
39980	Miniature Rocker Switch (183SA)		BLACK			
			12v			
						Max. panel thickness : 1.2 → 1.5 mm
						Max. panel thickness : 1.2 → 1.3 mm
145SA						
S0B967	Rotary Switch (145SA)	WIPERS	STANDARD			
		(Knob = 54340037)	12v			
						Max. current (A) 4 A 4 A

PANEL SWITCHES – PRODUCT SPECIFICATION



PART NO.	DESCRIPTION	FUNCTION	FINISH	PICTURE		DIAGRAM
		ILLUMINATION	VOLTAGE	TERMINATION	PANEL SYMBOL	CIRCUIT
		CONTACT	PIERCING			
<b>199SA</b>						
33714	Rotary Switch (199SA)	LIGHTING	STANDARD			
			12v / 24v			
						<p>Circuit 1: 11ED 2: SERIAL PANEL 3: DP 4: MAX. 5: HORNS</p> <p>Max. current (SD84): 40A 300A 200A 40A</p>
<b>RHEOSTATS</b>						
78405	Rheostat	Clockwise Rotation	STANDARD			
		Resistance 0-12.5 Ohms (Knob - 54340037)	12v / 24v			
54331311	Others					
54340037	Others					
<b>SD84</b>						
SPB120	Rotary Switch (SD84)		WHITE			
			12v			
			RED			

PANEL SWITCHES – PRODUCT SPECIFICATION





PART NO.	DESCRIPTION	FUNCTION	FINISH	PICTURE		DIAGRAM
		ILLUMINATION	VOLTAGE	TERMINATION	PANEL SYMBOL	CIRCUIT
		CONTACT	PIERCING			
<b>57SA</b>						
31743	Toggle Switch 2 or 3 position (57SA)	LEVER				
			12v / 24v			
31780	Toggle Switch 2 or 3 position (57SA)					
			12v / 24v			
31788	Toggle Switch 2 or 3 position (57SA)					
			12v / 24v			



PART NO.	DESCRIPTION	FUNCTION	FINISH	PICTURE		DIAGRAM
		ILLUMINATION	VOLTAGE	TERMINATION	PANEL SYMBOL	CIRCUIT
57SA CONTINUED						
34426	Toggle Switch 2 or 3 position (57SA)		12v / 24v			
						<p>Circuit</p> <p>Max. panel thickness : 3.1 mm</p>
35927	Toggle Switch 2 or 3 position (57SA)		12v / 24v			
						<p>Circuit</p> <p>Max. panel thickness : 2.6 mm</p>
65SA / 108SA						
SPB200	Toggle Switch 2 position (65SA / 108SA)		12v / 24v			
						<p>Circuit</p> <p>Max. panel thickness : 2.0 mm</p>

PANEL SWITCHES – PRODUCT SPECIFICATION



PART NO.	DESCRIPTION	FUNCTION		FINISH		PICTURE		DIAGRAM	
		ILLUMINATION	CONTACT	VOLTAGE	PIERCING	TERMINATION	PANEL SYMBOL	CIRCUIT	
<b>65SA / 108SA CONTINUED</b>									
SPB203	Toggle Switch 2 position (65SA / 108SA)								
			12v / 24v						
								Max. panel thickness : 2.0 mm	
SPB204	Toggle Switch 2 position (65SA / 108SA)								
			12v / 24v						
								Max. panel thickness : 2.2 mm	
34775	Toggle Switch 2 position (65SA / 108SA)								
			12v / 24v						
							Max. panel thickness : 2.2 mm		
34889	Toggle Switch 2 position (65SA / 108SA)								
			12v / 24v						
							Max. panel thickness : 2.2 mm		

PANEL SWITCHES – PRODUCT SPECIFICATION



PART NO.	DESCRIPTION	FUNCTION	FINISH	PICTURE		DIAGRAM
		ILLUMINATION	VOLTAGE	TERMINATION	PANEL SYMBOL	CIRCUIT
		CONTACT	PIERCING			
<b>182SA</b>						
33852	Lever Switch (182SA)	WINDOW LIFT	BLACK			
		GREEN	12v			
(Max. Panel thickness : 1.5-2.0 mm)						
<b>PUSH / PULL</b>						
SPB104	Pull/Push	PULL/PUSH	STANDARD			
		Resistive loads 12v - 10A 24v - 3A	12v / 24v			
(Max. Panel thickness : 8mm)						
SPB105		PUSH	CHROME			
		Pull/Push Inductive loads 12v - 11A 24v - 2.5A	12v / 24v			
(Max. Panel thickness : 3mm)						
SPB106		PUSH	CHROME			
		Pull/Push Inductive loads 12v - 11A 24v - 2.5A	12v / 24v			
(Max. Panel thickness : 3mm)						
SPB160		PUSH	BLACK			
		Inductive loads 12v - 5A	12v			

PANEL SWITCHES – PRODUCT SPECIFICATION

PART NO.	DESCRIPTION		PART NO.	DESCRIPTION		PART NO.	DESCRIPTION	
<b>OTHERS</b>								
30669	Panel Switch		39738	Panel Switch		SPB140	Horn / Dip	
30794	Panel Switch		39976	Panel Switch		SPB219	Reverse Light Switch	
33814	Panel Switch		54033632	Panel Switch		SPB220	Electric Window Rocker Switch	
33888	Panel Switch		54034069	Panel Switch		SPB221	Electric Window, Single Rocker Switch	
35476	Panel Switch		54329399	Panel Switch		SPB222	Switch	
36649	Panel Switch		SFB300	Panel Switch		SPB223	Electric Window, Single Rocker Switch	
39293	Panel Switch		SPB107	Panel Switch		SPB224	Electric Window, Double Rocker Switch	
39364	Panel Switch		SPB108	Accessories		SPB225	Electric Window Isolator Switch	

PANEL SWITCHES – PRODUCT SPECIFICATION



PART NO.	DESCRIPTION		PART NO.	DESCRIPTION		PART NO.	DESCRIPTION	
<b>OTHERS CONTINUED</b>								
SPB226	Sunroof Switch		SPB235	Seat Position Memory Switch		SPB243	Heated Seat Switch	
SPB227	Sunroof Switch		SPB236	Boot Release Left Hand Side Switch		SPB244	Traction Control Switch	
SPB229	Sunroof Switch		SPB237	Boot Release Right Side Switch		SPB245	Heated Rear Window Switch	
SPB230	Gearbox Snow Mode Switch		SPB238	Master Control Locking Switch		SPB247	Electric Window With Cluster Switch	
SPB231	Electric Window, Front Switch		SPB239	Cruise Control Switch		SPB248	Electric Mirror Switch	
SPB232	Electric Window, Front Switch		SPB240	Door Lock Switch		SPB253	Air Con Switch	
SPB233	Electric Window, Rear Switch		SPB241	Hazard Switch		SPB254	Heated Rear Window Switch	
SPB234	Hazard Switch		SPB242	Rear Sunblind Switch		SPB255	Heated Seat Switch	

PANEL SWITCHES – PRODUCT SPECIFICATION



PART NO.	DESCRIPTION		PART NO.	DESCRIPTION		PART NO.	DESCRIPTION	
<b>OTHERS CONTINUED</b>								
SPB256	Rear Fog Lamp Switch		SPB264	Blank Switch		SPB325	Overdrive Switch	
SPB257	Hazard Switch		SPB265	Transmission Mode Switch		SPB350	Switch Rocker	
SPB258	Electric Window Isolator Switch		SPB266	Gear Change Switch		SPB351	Switch Flick On/Off Metal Toggle	
SPB259	Panel Dimmer Switch		SPB310	Hazard Rocker Switch		SPB352	Switch Flick On/Off Splashproof Metal Toggle	
SPB260	Headlight Adjustment Switch		SPB311	Fan Switch		SPB353	Switch Momentary Push Button 12v	
SPB261	Headlight Adjustment Switch		SPB314	Electric Window Front Switch		SPB354	Warning Light Red 12 volt	
SPB262	Headlight Adjustment Switch		SPB315	Electric Window Switch		SPB355	Warning Light Green 12 volt	
SPB263	Headlight Adjustment Switch		SPB316	Electric Window With Boot Release Switch		SPB356	Warning Light Blue 12 volt	

PANEL SWITCHES – PRODUCT SPECIFICATION



PART NO.	DESCRIPTION		PART NO.	DESCRIPTION		PART NO.	DESCRIPTION	
<b>OTHERS CONTINUED</b>								
SPB357	Warning Light Amber 12 volt		SPB365	Switch Flick Momentary On Long Paddle 12v		SPB373	Insert - Windscreen Wiper with Wash	
SPB358	Switch Flick 3 Way/Change Over Metal Toggle		SPB366	Switch, illuminated 12V		SPB374	Insert - Rear Windscreen Wiper	
SPB359	Switch Flick 3 Way Momentary On/Off/ Momentary On Metal Toggle		SPB367	Switch, illuminated 24V		SPB375	Insert - Rear Windscreen Wiper with Wash	
SPB360	Warning Light Red 6.3mm terminals		SPB368	Switch, illuminated with lock in on position 12V		SPB376	Insert - Interior Light	
SPB361	Warning Light Green 6.3mm Term		SPB369	Switch, illuminated with lock in on position 24V		SPB377	Insert - Foglamp	
SPB362	Warning Light Amber 6.3mm Term		SPB370	Switch, illuminated with lock in on & off position 12V		SPB378	Insert - Worklamp	
SPB363	Warning Light Blue 6.3mm Term		SPB371	Switch, illuminated with lock in on & off position 24V		SPB379	Insert - Main Lighting	
SPB364	Switch Push/Pull Off/Side/Head Light 12v		SPB372	Insert - Windscreen Wiper		SPB380	Insert - Rotating Beacon	





PART NO.	DESCRIPTION		PART NO.	DESCRIPTION		PART NO.	DESCRIPTION	
<b>OTHERS CONTINUED</b>								
SPB381	Insert - Hazard Warning		SPC100	Switch Component		SQB714	H Gate LHD	
SPB382	Insert - Rear Demister		SQB704	Panel Switch		SQB715	Panel Display	
SPB383	Mounting Frame for 6 Switches		SQB705	Panel Switch		SQB716	Panel Display	
SPB384	Mounting Frame for 3 Switches		SQB706	Panel Switch		SQB717	Panel Display	
SPB385	Mounting Frame end piece		SQB710	Panel Switch		SRB311	Starter Switch	
SPB386	Mounting Frame intermediary piece		SQB711	Panel Switch		SRB312	Panel Switch	
SPB387	Mounting Frame for 1 switch		SQB712	Panel Switch				
SPB388	Blank insert		SQB713	Panel Switch				

PANEL SWITCHES – PRODUCT SPECIFICATION



A large, empty rectangular box with a thin black border, intended for handwritten notes.





## Ignition Switches

Application List

Page 3.70

Product Specification

Page 3.76

# Ignition Switches 3



MODEL	TYPE	FUNCTION	ENGINE INFO	CC	YEAR	PART NO.
<b>AVELING BARFORD</b>						
400 Super Grader	Ignition Switch (128SA)	4 Position Ignition Switch			1980 >>	35703
700 Super Grader	Ignition Switch (128SA)	4 Position Ignition Switch			1980 >>	35703
ASG 013 Grader	Ignition Switch (S45)	On/Off Ignition Switch			1977 >>	30608
ASG 013 Grader	Ignition Switch (128SA)	4 Position Ignition Switch			1977 >>	35703
ASG 018 Grader	Ignition Switch (S45)	On/Off Ignition Switch	GM 6V71		1977 >>	30608
ASG 018 Grader	Ignition Switch (128SA)	4 Position Ignition Switch	GM 6V71		1977 >>	35703
GAX Road Roller	Ignition Switch (128SA)	4 Position Ignition Switch			1977-80	35703
GAY Road Roller	Ignition Switch (128SA)	4 Position Ignition Switch			1977-80	35703
GRT, GRY Road Roller	Ignition Switch (128SA)	4 Position Ignition Switch		2500	1977-80	35703
MG Grader	Ignition Switch (S45)	On/Off Ignition Switch		6540	1977-79	30608
MG Grader	Ignition Switch (128SA)	4 Position Ignition Switch		6540	1977-79	35703
MG4 Grader	Ignition Switch (S45)	On/Off Ignition Switch			1977-79	30608
MG4 Grader	Ignition Switch (128SA)	4 Position Ignition Switch			1977-79	35703
PM20 Road Roller	Ignition Switch (128SA)	4 Position Ignition Switch			1977-78	35703
RD 17 Rigid Dump Truck	Ignition Switch (S45)	On/Off Ignition Switch		11094	1977 >>	30608
SL 340 Dump Truck	Ignition Switch (S45)	On/Off Ignition Switch		11094	1977 >>	30608
TG 011 Grader	Ignition Switch (S45)	On/Off Ignition Switch	Leyland 401, 466		1977 >>	30608
TG 011 Grader	Ignition Switch (128SA)	4 Position Ignition Switch	Leyland 401, 466		1977 >>	35703
TS 200 Tractor Loading Shovel	Ignition Switch (S45)	On/Off Ignition Switch			1977 >>	30608
TS 230 Tractor Loading Shovel	Ignition Switch (S45)	On/Off Ignition Switch			1977 >>	30608
TS 350 Tractor Loading Shovel	Ignition Switch (S45)	On/Off Ignition Switch		11094	1977 >>	30608
TS 350P, 500P Tractor Loading Shovel	Ignition Switch (S45)	On/Off Ignition Switch			1977 >>	30608
WXL 012, 017 Wheeled Loader	Ignition Switch (128SA)	4 Position Ignition Switch			1979 >>	35703
WXL 024 Wheeled Loader	Ignition Switch (128SA)	4 Position Ignition Switch			1979 >>	35703
<b>CASE INTERNATIONAL</b>						
1190 Tractor	Ignition Switch (128SA)	4 Position Ignition Switch			1980-83	35670
1194 Tractor	Ignition Switch (128SA)	4 Position Ignition Switch			1984-85	35670
1210, 1212 Tractor	Ignition Switch (128SA)	Ignition Switch 3 Position			1972-81	33940
1210, 1212 Tractor	Ignition Switch (128SA)	4 Position Ignition Switch			1972-81	35670
1290 Tractor 2WD	Ignition Switch (128SA)	4 Position Ignition Switch			1980-83	35670
1290 Tractor 4WD	Ignition Switch (128SA)	4 Position Ignition Switch			1980-83	35670
1294 Tractor 2WD	Ignition Switch (128SA)	4 Position Ignition Switch		3594	1984-85	35670
1390 Tractor 2WD, 4WD	Ignition Switch (128SA)	4 Position Ignition Switch			1980-83	35670
1394 Tractor 2WD	Ignition Switch (128SA)	4 Position Ignition Switch		3594	1984-88	35670
1410, 1412 Tractor	Ignition Switch (128SA)	4 Position Ignition Switch			1975-81	35670
1490 Tractor 2WD, 4WD	Ignition Switch (128SA)	4 Position Ignition Switch			1980-83	35670
1494 Tractor 2WD	Ignition Switch (128SA)	4 Position Ignition Switch		3594	1984-87	35670
1594 Tractor 2WD	Ignition Switch (128SA)	4 Position Ignition Switch		5392	1984-88	35670
1690 Tractor 2WD, 4WD	Ignition Switch (128SA)	4 Position Ignition Switch			1980-83	35670
1694 Tractor	Ignition Switch (128SA)	4 Position Ignition Switch		5392	1984-87	35670
3434 Tractor (Skid-Steer)	Ignition Switch (128SA)	Ignition Switch			1976-81	33942
384 Tractor	Ignition Switch (128SA)	Ignition Switch			1977-82	33942
384 Tractor	Ignition Switch (128SA)	Ignition Switch 3 Position			1977-82	33940
444 Tractor	Ignition Switch (128SA)	Ignition Switch			1963-82	33942
484 Tractor	Ignition Switch (128SA)	Ignition Switch 3 Position			1977-82	33940
484 Tractor	Ignition Switch (128SA)	Ignition Switch			1977-82	33942
585L Tractor	Ignition Switch (128SA)	Ignition Switch 3 Position		3382	1981-82	33940
585L Tractor	Ignition Switch (128SA)	Ignition Switch		3382	1981-82	33942
684 Tractor	Ignition Switch (128SA)	Ignition Switch 3 Position			1977-80	33940
684 Tractor	Ignition Switch (128SA)	Ignition Switch			1977-80	33942
784 Tractor	Ignition Switch (128SA)	Ignition Switch 3 Position			1977-80	33940
784 Tractor	Ignition Switch (128SA)	Ignition Switch			1977-80	33942
885G Tractor (Diesel)	Ignition Switch (128SA)	Ignition Switch 3 Position			1972-83	33940
885G Tractor (Diesel)	Ignition Switch (128SA)	4 Position Ignition Switch			1972-83	35670
885G Tractor (Petrol)	Ignition Switch (128SA)	Ignition Switch 3 Position			1972-81	33940
885G Tractor (Petrol)	Ignition Switch (128SA)	4 Position Ignition Switch			1972-81	35670
885L Tractor	Ignition Switch (128SA)	4 Position Ignition Switch			1972-81	35670
885L Tractor	Ignition Switch (128SA)	Ignition Switch 3 Position			1972-83	33940
885N Tractor (Diesel)	Ignition Switch (128SA)	Ignition Switch 3 Position			1972-83	33940
885N Tractor (Diesel)	Ignition Switch (128SA)	4 Position Ignition Switch			1972-83	35670
885N Tractor (Petrol)	Ignition Switch (128SA)	Ignition Switch 3 Position			1972-81	33940
885N Tractor (Petrol)	Ignition Switch (128SA)	4 Position Ignition Switch			1972-81	35670
990 Highway Tractor	Ignition Switch (128SA)	Ignition Switch 3 Position			1976-83	33940
990 Highway Tractor	Ignition Switch (128SA)	4 Position Ignition Switch			1976-83	35670
990 Highway Tractor (Selectomatic)	Ignition Switch (128SA)	Ignition Switch 3 Position			1978-83	33940
990 Highway Tractor (Selectomatic)	Ignition Switch (128SA)	4 Position Ignition Switch			1978-83	35670
990 Tractor	Ignition Switch (128SA)	Ignition Switch 3 Position			1964-72	33940
990 Tractor	Ignition Switch (128SA)	4 Position Ignition Switch			1964-72	35670

IGNITION SWITCHES – APPLICATION LIST



MODEL	TYPE	FUNCTION	ENGINE INFO	CC	YEAR	PART NO.
<b>CASE INTERNATIONAL CONTINUED</b>						
990/1 Tractor	Ignition Switch (128SA)	Ignition Switch 3 Position			1972-81	33940
990/1 Tractor	Ignition Switch (128SA)	4 Position Ignition Switch			1972-81	35670
995 Tractor	Ignition Switch (128SA)	Ignition Switch 3 Position			1964-81	33940
995 Tractor	Ignition Switch (128SA)	4 Position Ignition Switch			1964-81	35670
996 Tractor	Ignition Switch (128SA)	Ignition Switch 3 Position			1964-81	33940
996 Tractor	Ignition Switch (128SA)	4 Position Ignition Switch			1964-81	35670
B 165 Excavator	Ignition Switch (128SA)	Ignition Switch 3 Position			1977-82	33940
<b>CONVEYANCER</b>						
E2, E2C, E3, E3C, E4, E5, E6, E7, E8	Ignition Switch (S45)	Ignition Switch On/Off			1973-78	31287
RE2A, RE3A	Ignition Switch (S45)	Ignition Switch On/Off			1973-78	31287
<b>DENNIS SPECIALIST VEHICLES</b>						
Fire Engine: D Range	Ignition Switch (128SA)	Ignition Switch 3 Position		4235	1972-76	33940
Fire Engine: F Range	Ignition Switch (128SA)	Ignition Switch 3 Position			1972 >>	33940
Fire Engine: R Range	Ignition Switch (128SA)	Ignition Switch 3 Position			1978-79	33940
<b>FODEN</b>						
S21 FC	Ignition Switch (S45)	On/Off Ignition Switch			1973-79	30608
S21 FG	Ignition Switch (S45)	On/Off Ignition Switch			1969-78	30608
S39	Ignition Switch (S45)	On/Off Ignition Switch			1969-79	30608
S50 (Steel Cab)	Ignition Switch (S45)	On/Off Ignition Switch			1969-72	30608
<b>JCB</b>						
2D Loader (Leyland 384/4)	Ignition Switch (128SA)	Ignition Switch 3 Position			>> 1980	33940
2D Loader (Leyland 4/65)	Ignition Switch (128SA)	Ignition Switch 3 Position			1971-80	33940
3 Loader (Leyland 384/4)	Ignition Switch (128SA)	Ignition Switch 3 Position			1972 >>	33940
3 Loader (Leyland 4/65)	Ignition Switch (128SA)	Ignition Switch 3 Position			1971 >>	33940
3C Loader (Leyland 384/4)	Ignition Switch (128SA)	Ignition Switch 3 Position			1972-80	33940
3C Loader (Leyland 4/65)	Ignition Switch (128SA)	Ignition Switch 3 Position			1971 >>	33940
3CX Backhoe-Loader (Leyland)	Ignition Switch (128SA)	Ignition Switch Water Proofed		3770	1980-81	33820
3CX Backhoe-Loader (Perkins 4.236)	Ignition Switch (128SA)	Ignition Switch Water Proofed		3860	1981-90	33820
3D Loader (Leyland 384/4)	Ignition Switch (128SA)	Ignition Switch 3 Position			1972-80	33940
3D Loader (Leyland 4/65)	Ignition Switch (128SA)	Ignition Switch 3 Position			1971 >>	33940
3D Loader (Leyland 4:98T)	Ignition Switch (128SA)	Ignition Switch Water Proofed		3770	1972 >>	33820
3D, 3DS Loader (Perkins)	Ignition Switch (128SA)	Ignition Switch Water Proofed		3860	1981 >>	33820
3DS Loader (Leyland)	Ignition Switch (128SA)	Ignition Switch Water Proofed		3770	1980-81	33820
410 Loader	Ignition Switch (128SA)	Ignition Switch Water Proofed		3860	1982-94	33820
420 Loader	Ignition Switch (128SA)	Ignition Switch Water Proofed		5800	1982-91	33820
423 Loader, 428, 428C Loader	Ignition Switch (128SA)	4 Position Ignition Switch		11094	1976-87	35670
430 Loader	Ignition Switch (128SA)	Ignition Switch Water Proofed		5800	1983-89	33820
4D Loader (Leyland 384/4)	Ignition Switch (128SA)	Ignition Switch 3 Position			1972-80	33940
4D Loader (Leyland 4/65)	Ignition Switch (128SA)	Ignition Switch 3 Position			1969-80	33940
520 Loadall	Ignition Switch (128SA)	4 Position Ignition Switch		3770	1975-81	35670
520-2, 520-4 Loadall	Ignition Switch (128SA)	4 Position Ignition Switch		3860	1982-87	35670
525-2, 525-4 Loadall	Ignition Switch (128SA)	4 Position Ignition Switch		3860	1982-83	35670
525B Loadall	Ignition Switch (128SA)	4 Position Ignition Switch		3860	1983-87	35670
530-2, 530-4 Loadall	Ignition Switch (128SA)	4 Position Ignition Switch		3860	1983-87	35670
805B Excavator	Ignition Switch (128SA)	Ignition Switch Water Proofed		5800	1978-82	33820
805BT Excavator	Ignition Switch (128SA)	Ignition Switch Water Proofed		3860	1982 >>	33820
<b>JONES CRANES</b>						
Iron Fairy Garnet, Opal Mobile Crane	Ignition Switch	Ignition Switch			1971-78	31270
Iron Fairy Sapphire 6, 7, 8 Ton Mobile Crane	Ignition Switch	Ignition Switch			1971-78	31270
Iron Fairy Six 6, 8, 10 Ton Mobile Crane	Ignition Switch	Ignition Switch			1971-80	31270
Iron Fairy Tourmaline	Ignition Switch	Ignition Switch			1973-78	31270
<b>LANCER BOSS</b>						
BD20, 23, 26 Fork Lift (LPG)	Ignition Switch (128SA)	4 Position Ignition Switch		6220		35670
CD15, 18, 20 Fork Lift (LPG)	Ignition Switch (128SA)	4 Position Ignition Switch		6220		35670



MODEL	TYPE	FUNCTION	ENGINE INFO	CC	YEAR	PART NO.
<b>LAND ROVER</b>						
Land Rover (110) 2.5 Diesel	Ignition Switch (128SA)	4 Position Ignition Switch	4 Cyl 12J	2495	1984-90	35288
Land Rover (110) 2.5 Turbo Diesel	Ignition Switch (128SA)	4 Position Ignition Switch	4 Cyl	2495	1986-90	35288
Land Rover (90) 2.5 Diesel	Ignition Switch (128SA)	4 Position Ignition Switch	4 Cyl 12J	2495	1985-90	35288
Land Rover (90) 2.5 Turbo Diesel	Ignition Switch (128SA)	4 Position Ignition Switch	4 Cyl	2495	1986-90	35288
Land Rover Defender 110 2.5	Ignition Switch (128SA)	4 Position Ignition Switch	4 Cyl	2495	1990-92	35288
Land Rover Defender 110 2.5 D	Ignition Switch (128SA)	4 Position Ignition Switch	4 Cyl	2495	1990-93	35288
Land Rover Defender 110 2.5 Tdi (300)	Ignition Switch (128SA)	4 Position Ignition Switch	4 Cyl	2495	1994-98	35288
Land Rover Defender 110 V8	Ignition Switch (128SA)	4 Position Ignition Switch		3528	1990-95	35288
Land Rover Defender 130 2.5 Tdi	Ignition Switch (128SA)	4 Position Ignition Switch	4 Cyl	2495	1990-94	35288
Land Rover Defender 130 V8	Ignition Switch (128SA)	4 Position Ignition Switch		3528	1990-95	35288
Land Rover Defender 90 2.5, 90 2.5 D, Tdi	Ignition Switch (128SA)	4 Position Ignition Switch	4 Cyl	2495	1990-94	35288
Land Rover Defender 90 V8	Ignition Switch (128SA)	4 Position Ignition Switch	V8	3528	1990-95	35288
Land Rover Defender 90, 110 Diesel	Ignition Switch	Steering Lock				SSB301
Land Rover Defender 90, 110 Petrol	Ignition Switch	Steering Lock				SSB300
	Ignition Switch	Steering Lock				SSB302
	Ignition Switch	Steering Lock				SSB303
	Ignition Switch	Steering Lock				SSB304
	Ignition Switch	Steering Lock				SSB305
<b>LEYLAND DAF</b>						
Boxer BX1000 Truck	Ignition Switch (47SA)	3 Position Ignition Switch Off/On/Start		5655	1972-77	31973
Boxer BX1200 Truck	Ignition Switch (47SA)	3 Position Ignition Switch Off/On/Start		5655	1972-77	31973
Boxer BX1300 Truck	Ignition Switch (47SA)	3 Position Ignition Switch Off/On/Start		5655	1972-77	31973
Boxer BX1425	Ignition Switch (47SA)	3 Position Ignition Switch Off/On/Start			1972-77	31973
Boxer BX1450	Ignition Switch (47SA)	3 Position Ignition Switch Off/On/Start			1975-77	31973
Boxer BX1600 Truck	Ignition Switch (47SA)	3 Position Ignition Switch Off/On/Start			1972-77	31973
Boxer BX16TA Tractor Unit	Ignition Switch (47SA)	3 Position Ignition Switch Off/On/Start		5655	1971-77	31973
Boxer BX20TF Tractor Unit	Ignition Switch (47SA)	3 Position Ignition Switch Off/On/Start		5655	1971-77	31973
Chieftain CH40.13L, 13N, 13T, 13XL	Ignition Switch (47SA)	3 Position Ignition Switch Off/On/Start		6540	1974	31973
Chieftain CH40.19A, 19B	Ignition Switch (47SA)	3 Position Ignition Switch Off/On/Start		6540	1974-77	31973
Chieftain CH40.19ATR	Ignition Switch (47SA)	3 Position Ignition Switch Off/On/Start		6540	1974-75	31973
Chieftain CH40.20A, CH40.20B	Ignition Switch (47SA)	3 Position Ignition Switch Off/On/Start		6540	1974-77	31973
Chieftain CH40.20ATR	Ignition Switch (47SA)	3 Position Ignition Switch Off/On/Start		6540	1974-75	31973
Chieftain CH41.13A, B	Ignition Switch (47SA)	3 Position Ignition Switch Off/On/Start		6540	1975-77	31973
Chieftain CH41.19A	Ignition Switch (47SA)	3 Position Ignition Switch Off/On/Start		6540	1974-77	31973
Chieftain CH41.19ATR	Ignition Switch (47SA)	3 Position Ignition Switch Off/On/Start		6540	1975-77	31973
Chieftain CH41.19B	Ignition Switch (47SA)	3 Position Ignition Switch Off/On/Start		6540	1974-77	31973
Chieftain CH41.20A, CH41.20B	Ignition Switch (47SA)	3 Position Ignition Switch Off/On/Start		6540	1975-77	31973
Chieftain CH41.20ATR	Ignition Switch (47SA)	3 Position Ignition Switch Off/On/Start		6540	1975-77	31973
Clydesdale 2CD40.16A	Ignition Switch (47SA)	3 Position Ignition Switch Off/On/Start		6540	01/77-10/77	31973
Clydesdale 2CD41.16A	Ignition Switch (47SA)	3 Position Ignition Switch Off/On/Start		6540	01/77-10/77	31973
Clydesdale 2CD41.24A	Ignition Switch (47SA)	3 Position Ignition Switch Off/On/Start		6540	01/77-10/77	31973
EA 345 Van (2.5), Diesel	Ignition Switch (128SA)	4 Position Ignition Switch		2520	1975-77	35703
EA 350 Van (2.5), Diesel	Ignition Switch (128SA)	4 Position Ignition Switch		2520	1973-75	35703
EA 420 Van (2.5)	Ignition Switch (128SA)	4 Position Ignition Switch		2520	1973-76	35703
EA 420 Van (2.5) Diesel	Ignition Switch (128SA)	4 Position Ignition Switch		2520	1973-79	35703

IGNITION SWITCHES – APPLICATION LIST



MODEL	TYPE	FUNCTION	ENGINE INFO	CC	YEAR	PART NO.
<b>LEYLAND DAF CONTINUED</b>						
EA 440 Van (2.5), Diesel	Ignition Switch (128SA)	4 Position Ignition Switch		2520	1973-81	35703
FG 345 Truck (2.5), Diesel	Ignition Switch (47SA)	3 Position Ignition Switch Off/On/Start		2520	1975-79	31973
FG 350 Truck (2.5)	Ignition Switch (47SA)	3 Position Ignition Switch Off/On/Start		2520	1974-75	31973
FG 350 Truck (2.5) Diesel	Ignition Switch (47SA)	3 Position Ignition Switch Off/On/Start		2520	1973-75	31973
FG 420 Truck (2.5)	Ignition Switch (47SA)	3 Position Ignition Switch Off/On/Start		2520	1974-79	31973
FG 420 Truck (2.5) Diesel	Ignition Switch (47SA)	3 Position Ignition Switch Off/On/Start		2520	1972-79	31973
FG 420 Truck (3.8) Diesel	Ignition Switch (47SA)	3 Position Ignition Switch Off/On/Start		3770	1964-74	31973
FG 550 Truck (3.8) Diesel	Ignition Switch (47SA)	3 Position Ignition Switch Off/On/Start		3770	1972-79	31973
J4 180 1500 Diesel, 1600	Ignition Switch (128SA)	Ignition Switch 3 Position			1969-74	33940
J4 190 1500 Diesel, 1600	Ignition Switch (128SA)	Ignition Switch 3 Position			1969-74	33940
J4 200 1500 Diesel	Ignition Switch (128SA)	Ignition Switch 3 Position		1489	1969-74	33940
J4 200 1600	Ignition Switch (128SA)	Ignition Switch 3 Position		1622	1969-74	33940
Mastiff MS1600 Truck, MS2600, MS2800 Tractor Unit	Ignition Switch (47SA)	3 Position Ignition Switch Off/On/Start		8830	03/69-81	31973
Reiver 2RE41.22A Six Wheeler	Ignition Switch (47SA)	3 Position Ignition Switch Off/On/Start		6540	01/77-10/77	31973
Reiver 2RE41.24A Six Wheeler	Ignition Switch (47SA)	3 Position Ignition Switch Off/On/Start		6540	01/77-10/77	31973
Reiver 2RE41.24B Six Wheeler	Ignition Switch (47SA)	3 Position Ignition Switch Off/On/Start		6540	1969-81	31973
Super Mastiff SM2200 6x4 Tipper, Truck	Ignition Switch (47SA)	3 Position Ignition Switch Off/On/Start		8830	10/72-11/79	31973
Super Mastiff SM2400 6x4 Tipper, Truck	Ignition Switch (47SA)	3 Position Ignition Switch Off/On/Start		8830	10/72-81	31973
Terrier TR650 4x2 Tipper, Truck	Ignition Switch (47SA)	3 Position Ignition Switch Off/On/Start			09/72-07/84	31973
Terrier TR738 4x2 Tipper, Truck	Ignition Switch (47SA)	3 Position Ignition Switch Off/On/Start			03/73-09/84	31973
Terrier TR850 4x2 Tipper, Truck	Ignition Switch (47SA)	3 Position Ignition Switch Off/On/Start		5655	09/72-11/83	31973
Terrier TR950 4x2 Tipper, Truck	Ignition Switch (47SA)	3 Position Ignition Switch Off/On/Start		5655	09/72-06/84	31973
<b>MARSHALL TRACTORS</b>						
154 Tractor	Ignition Switch (128SA)	Ignition Switch 3 Position			1970-79	33940
2100 Tractor	Ignition Switch (128SA)	Ignition Switch 3 Position		5655	1970-81	33940
245 Tractor	Ignition Switch (128SA)	Ignition Switch 3 Position		2500	1973-81	33940
245S Tractor	Ignition Switch (128SA)	Ignition Switch 3 Position		2500	1973-81	33940
255 Tractor	Ignition Switch (128SA)	Ignition Switch 3 Position		3770	1973-76	33940
262 Tractor	Ignition Switch (128SA)	Ignition Switch 3 Position		3770	1976-81	33940
262S Tractor	Ignition Switch (128SA)	Ignition Switch 3 Position		3770	1977-81	33940
270 Tractor	Ignition Switch (128SA)	Ignition Switch 3 Position		3770	1973-76	33940
272 Tractor	Ignition Switch (128SA)	Ignition Switch 3 Position		3770	1969-81	33940
272S Tractor	Ignition Switch (128SA)	Ignition Switch 3 Position		3770	1977-81	33940
285 Tractor	Ignition Switch (128SA)	Ignition Switch 3 Position		5655	1974-81	33940
285-4 Tractor	Ignition Switch (128SA)	Ignition Switch 3 Position	4 Cyl		1974-81	33940
4100 Tractor	Ignition Switch (128SA)	Ignition Switch 3 Position		5655	1974-81	33940
472S Tractor	Ignition Switch (128SA)	Ignition Switch 3 Position		3770	1977-81	33940
485 Tractor	Ignition Switch (128SA)	Ignition Switch 3 Position		5655	1976-79	33940
502 Tractor	Ignition Switch (128SA)	Ignition Switch 3 Position		2500	1981-85	33940
502S Tractor	Ignition Switch (128SA)	Ignition Switch 3 Position		2500	1981-85	33940
602S Tractor	Ignition Switch (128SA)	4 Position Ignition Switch		3770	1981	35703
604 Tractor	Ignition Switch (128SA)	Ignition Switch 3 Position		3770	1980-85	33940
604 Tractor	Ignition Switch (128SA)	4 Position Ignition Switch		3770	1980-85	35703
604S Tractor	Ignition Switch (128SA)	4 Position Ignition Switch		3770	1981	35703
702S Tractor	Ignition Switch (128SA)	4 Position Ignition Switch		3770	1981	35703
802 Tractor	Ignition Switch (128SA)	Ignition Switch 3 Position		3770	1981-85	33940
802S Tractor, 804S Tractor	Ignition Switch (128SA)	4 Position Ignition Switch		3770	1981	35703
804 Tractor	Ignition Switch (128SA)	Ignition Switch 3 Position		3770	1980-85	33940
804 Tractor	Ignition Switch (128SA)	4 Position Ignition Switch		3770	1980-85	35703

IGNITION SWITCHES – APPLICATION LIST



MODEL	TYPE	FUNCTION	ENGINE INFO	CC	YEAR	PART NO.
<b>MASSEY FERGUSON</b>						
MF 250.3, 250.4 Tractor	Ignition Switch (128SA)	4 Position Ignition Switch		2500	1982 >>	35670
MF 265.4 Tractor	Ignition Switch (128SA)	4 Position Ignition Switch		3300	1976 >>	35670
MF 265.4 Tractor 4WD	Ignition Switch (128SA)	4 Position Ignition Switch		3860	1984 >>	35670
MF 265.8 Tractor	Ignition Switch (128SA)	4 Position Ignition Switch		3860	1977 >>	35670
MF 275 Tractor (Perkins 4.236)	Ignition Switch (128SA)	4 Position Ignition Switch			1979 >>	35670
MF 275 Tractor (Perkins 4.276)	Ignition Switch (128SA)	4 Position Ignition Switch		276cu	1979 >>	35670
MF 290 Tractor, Tractor 4WD	Ignition Switch (128SA)	4 Position Ignition Switch		3860	1980 >>	35670
MF 298 Tractor	Ignition Switch (128SA)	4 Position Ignition Switch		5210	1983-86	35670
MF 30 Backhoe-Loader	Ignition Switch (128SA)	4 Position Ignition Switch			1985-87	35670
MF 30 Drill	Ignition Switch (128SA)	4 Position Ignition Switch		2500	1973-81	35630
MF 30 Drill	Ignition Switch (128SA)	4 Position Ignition Switch		2500	1982-87	35670
MF 30.3	Ignition Switch (128SA)	4 Position Ignition Switch		2500	1975-81	35630
MF 30.3	Ignition Switch (128SA)	4 Position Ignition Switch		2500	1982 >>	35670
MF 30.4 (Perkins 4.203, 4212)	Ignition Switch (128SA)	4 Position Ignition Switch		3300	1969-81	35630
MF 30.4 (Perkins 4.203, 4212)	Ignition Switch (128SA)	4 Position Ignition Switch		3300	1982 >>	35670
MF 30-825	Ignition Switch (128SA)	4 Position Ignition Switch		107cu	>> 1981	35630
MF 30-825	Ignition Switch (128SA)	4 Position Ignition Switch		107cu	1982 >>	35670
MF 30C Tractor	Ignition Switch (128SA)	4 Position Ignition Switch			>> 1981	35630
MF 30C Tractor	Ignition Switch (128SA)	4 Position Ignition Switch			1982 >>	35670
MF 30D Tractor	Ignition Switch (128SA)	4 Position Ignition Switch		3860	1982 >>	35670
MF 30E "Powershuttle" Tractor	Ignition Switch (128SA)	4 Position Ignition Switch		2500	1985 >>	35670
MF 30E Tractor	Ignition Switch (128SA)	4 Position Ignition Switch		2500	1972-81	35630
MF 30E Tractor	Ignition Switch (128SA)	4 Position Ignition Switch		2500	1982 >>	35670
MF 30H Backhoe-Loader	Ignition Switch (128SA)	4 Position Ignition Switch		2500	>> 1981	35630
MF 30H Backhoe-Loader	Ignition Switch (128SA)	4 Position Ignition Switch		2500	1982 >>	35670
MF 40.3, 40.4 Tractor	Ignition Switch (128SA)	4 Position Ignition Switch		2500	1970 >>	35630
MF 40B Excavator, Loader	Ignition Switch (128SA)	4 Position Ignition Switch			1970 >>	35630
MF 40B Tractor Industrial	Ignition Switch (128SA)	4 Position Ignition Switch		3860	1970 >>	35630
MF 40E Tractor	Ignition Switch (128SA)	4 Position Ignition Switch			1985 >>	35630
MF 40U Tractor	Ignition Switch (128SA)	4 Position Ignition Switch		2500	1970-81	35630
MF 50 Tractor (Perkins 4.203)	Ignition Switch (128SA)	4 Position Ignition Switch		3300	1973 >>	35630
MF 50 Tractor (Perkins 4.212)	Ignition Switch (128SA)	4 Position Ignition Switch		212cu	1973 >>	35630
MF 50 Tractor (Perkins 4.236)	Ignition Switch (128SA)	4 Position Ignition Switch		3860	1973-79	35630
MF 50 Tractor (Skid-Steer)	Ignition Switch (128SA)	4 Position Ignition Switch		212cu	1973 >>	35630
MF 50 Tractor Turbo	Ignition Switch (128SA)	4 Position Ignition Switch		212cu	1973 >>	35630
MF 50B Excavator, Loader	Ignition Switch (128SA)	4 Position Ignition Switch			1973 >>	35630
MF 50B Tractor (Perkins 4.212)	Ignition Switch (128SA)	4 Position Ignition Switch		212cu	1974 >>	35630
MF 50B Tractor (Perkins 4.236)	Ignition Switch (128SA)	4 Position Ignition Switch		3860	1973 >>	35630
MF 50B Tractor Industrial	Ignition Switch (128SA)	4 Position Ignition Switch			1973 >>	35630
MF 50C Tractor	Ignition Switch (128SA)	4 Position Ignition Switch		3860	1973>>	35630
MF 50D Digger Loader	Ignition Switch (128SA)	4 Position Ignition Switch		3860	1982 >>	35630
MF 50E "Powershuttle"	Ignition Switch (128SA)	4 Position Ignition Switch		3860	1984 >>	35670
MF 50EX Tractor	Ignition Switch (128SA)	4 Position Ignition Switch		4060	1973 >>	35630
MF 50H, HX "Powershuttle" Backhoe-Loader	Ignition Switch (128SA)	4 Position Ignition Switch		3860	1984 >>	35670
MF 520 Combine	Ignition Switch (128SA)	Ignition Switch 3 Position		5800	1971-79	33940
MF 525 Combine	Ignition Switch (128SA)	Ignition Switch 3 Position		5800	1971 >>	33940
MF 525 Combine Turbo	Ignition Switch (128SA)	Ignition Switch 3 Position		5800	1977 >>	33940
MF 550.3 Tractor	Ignition Switch (128SA)	4 Position Ignition Switch		2500	1976-81	35670
MF 550.6 Tractor	Ignition Switch (128SA)	4 Position Ignition Switch		5800	1979-81	35670
MF 565 Combine, 575 Tractor, 590 Combine	Ignition Switch (128SA)	4 Position Ignition Switch			1976-81	35670
MF 620 Tractor, 625 Tractor	Ignition Switch (128SA)	Ignition Switch 3 Position		372cu	1971 >>	33940
<b>MISCELLANEOUS</b>						
Various Land Rover, Reliant, General Industrial	Ignition Switch					SPB501
<b>MUIR-HILL</b>						
A4000 Loading Shovel	Ignition Switch (128SA)	4 Position Ignition Switch		3860	1970 >>	35670
A5000 Loading Shovel	Ignition Switch (128SA)	4 Position Ignition Switch		5800	1970 >>	35670
B4000 Loading Shovel	Ignition Switch (128SA)	4 Position Ignition Switch			1970 >>	35670
B5000 Loading Shovel	Ignition Switch (128SA)	4 Position Ignition Switch		324cu	1970 >>	35670
F4000 Loading Shovel	Ignition Switch (128SA)	4 Position Ignition Switch		3860	1970 >>	35670
F5000 Loading Shovel (All Wheel & Rear Wheel Steer)	Ignition Switch (128SA)	4 Position Ignition Switch		5800	1970 >>	35670
<b>RELIANT</b>						
TW9B, C Mighty Ant	Ignition Switch (47SA)	3 Position Ignition Switch Off/On/Start		1493	1969-73	31973
TW9E Mighty Ant	Ignition Switch (47SA)	3 Position Ignition Switch Off/On/Start		748	1969-80	31973

IGNITION SWITCHES – APPLICATION LIST



MODEL	TYPE	FUNCTION	ENGINE INFO	CC	YEAR	PART NO.
<b>ROVER</b>						
Austin-Healey Sprite (Mk 3/4)	Ignition Switch (47SA)	3 Position Ignition Switch Off/On/Start		1275	1969-72	31973
MG Midget 1300	Ignition Switch (47SA)	3 Position Ignition Switch Off/On/Start		1275	1969-74	31973
MGB	Ignition Switch (47SA)	3 Position Ignition Switch Off/On/Start	Where Steering Lock Not Fitted	1798	1964-76	31973
MGB GT	Ignition Switch (47SA)	3 Position Ignition Switch Off/On/Start	Where Steering Lock Not Fitted	1798	1964-76	31973
Mini All Models	Ignition Switch (47SA)	3 Position Ignition Switch Off/On/Start			1962-69	31973
Wolseley 1300	Ignition Switch (47SA)	3 Position Ignition Switch Off/On/Start		1275	1968-73	31973
Wolseley 18/85, 18/85.5	Ignition Switch (47SA)	3 Position Ignition Switch Off/On/Start		1798	1969-72	31973
<b>RVI (RTI)</b>						
500 K1050 16 Ton 4x2 Rigid, Truck	Ignition Switch (128SA)	4 Position Ignition Switch			1970-75	35288
500 K1100 16 Ton 4x2 Rigid	Ignition Switch (128SA)	4 Position Ignition Switch			1969-74	35288
500 K1613 16 Ton 4x2 Rigid	Ignition Switch (128SA)	4 Position Ignition Switch	Perkins V8	8360	1969-77	35288
500 K2011P, K2211P 20 Ton 6x2 Tractor Unit	Ignition Switch (128SA)	4 Position Ignition Switch		5800	1969-78	35288
500 K2213T 22 Ton 6x4 Rigid	Ignition Switch (128SA)	4 Position Ignition Switch		8360	1969-78	35288
500 K2413P 24 Ton 6x4 Tractor Unit	Ignition Switch (128SA)	4 Position Ignition Switch		8360	1969-78	35288
500 K2413R 24 Ton 6x4 Rigid	Ignition Switch (128SA)	4 Position Ignition Switch	Perkins V8	8360	1969-78	35288
500 K2413T 24 Ton 6x4 Rigid	Ignition Switch (128SA)	4 Position Ignition Switch	Perkins V8	8360	1969-78	35288
500 K2813P 28 Ton 6x4 Tractor Unit	Ignition Switch (128SA)	4 Position Ignition Switch	Perkins V8	8360	1969-78	35288
500 K3820D 38 Ton 6x4 Tractor Unit	Ignition Switch (128SA)	4 Position Ignition Switch			1969-78	35288
500 K3820P 38 Ton 6x4 Tractor Unit	Ignition Switch (128SA)	4 Position Ignition Switch	6 Cyl Chrysler	11946	1973-76	35288
500 K850 4x2 Rigid, Truck	Ignition Switch (128SA)	4 Position Ignition Switch			1969-78	35288
500 K950 4x2 Rigid, Truck	Ignition Switch (128SA)	4 Position Ignition Switch			1969-78	35288
500 KL500, KL600 Truck	Ignition Switch (128SA)	4 Position Ignition Switch		5800	1969-78	35288
500 KP1000 28 Ton 6x2 Tractor Unit	Ignition Switch (128SA)	4 Position Ignition Switch			1969-78	35288
500 KP700 20 Ton 4x2 Tractor Unit	Ignition Switch (128SA)	4 Position Ignition Switch			1969-78	35288
500 KP850, 950 22 Ton 4x2 Tractor Unit	Ignition Switch (128SA)	4 Position Ignition Switch			1969-78	35288
500 KR900 22 Ton 6x2 Rigid	Ignition Switch (128SA)	4 Position Ignition Switch			1969-78	35288
500 KT900 22 Ton 6x4 Rigid	Ignition Switch (128SA)	4 Position Ignition Switch			1969-78	35288
Bantam FBH322, 398 3.0 Ton Platform Truck	Ignition Switch (128SA)	4 Position Ignition Switch		2266	1974-78	35288
Bantam FBT1322, 1398 3.0 Ton Platform Truck	Ignition Switch (128SA)	4 Position Ignition Switch		3330	1974-78	35288
<b>VOLVO LEYLAND (AEC)</b>						
National II	Ignition Switch (128SA)	4 Position Ignition Switch			1973-78	39798
Titan (Leyland TL11)	Ignition Switch (128SA)	Ignition Switch			1979	33838
Titan (Leyland TL11)	Ignition Switch (128SA)	4 Position Ignition Switch			1979	39798
Victory (Gardner 6LX) (Leyland 680)	Ignition Switch (128SA)	Ignition Switch 3 Position			1971-73	33940
Victory J (Gardner 6LX)	Ignition Switch (128SA)	Ignition Switch 3 Position		10450	1971-73	33940
Victory, J (Gardner 6LXB)	Ignition Switch (128SA)	Ignition Switch 3 Position		10450	1974-77	33940

IGNITION SWITCHES – APPLICATION LIST



The power to SWITCH

PART NO.	DESCRIPTION	VOLTAGE	FINISH	KEY	POSITIONS	PIERCING BASE	DIAGRAM CIRCUIT
<b>S45 / 47SA</b>							
30608	S45	12v 24v	STANDARD	K1	2		
31287	S45	12v 24v	CHROME	K1	2		
31973	47SA	12v	STANDARD	K1	3		
<b>128SA</b>							
33820	128SA	12v 24v	NEOPRENE	K3	4		

IGNITION SWITCHES – PRODUCT SPECIFICATION













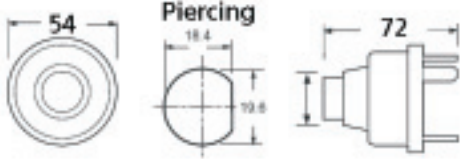

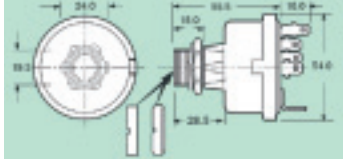
PART NO.	DESCRIPTION	VOLTAGE	FINISH	KEY	POSITIONS	PIERCING BASE	DIAGRAM CIRCUIT
<b>128SA CONTINUED</b>							
33838	128SA	12v 24v	STANDARD	K4	4		
33884	128SA	12v 24v	NEOPRENE	K1	4		
33940	128SA	12v	CRONAK	K3	3		
33942	128SA	12v 24v	CRONAK	K3	4		

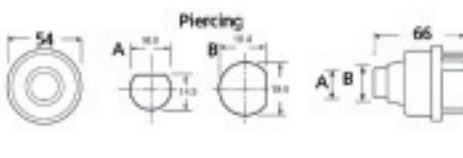

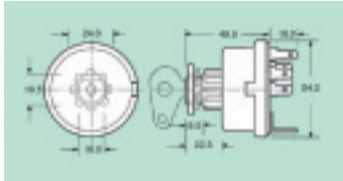
PART NO.	DESCRIPTION	VOLTAGE	FINISH	KEY	POSITIONS	PIERCING BASE	DIAGRAM CIRCUIT
<b>128SA CONTINUED</b>							
35288	128SA	12v 24v	STANDARD	K1	4		
35630	128SA	12v 24v	STANDARD	K3	4		
35670	128SA	12v 24v	STANDARD	K3	4		
35703	128SA	12v 24v	STANDARD	K1	4		

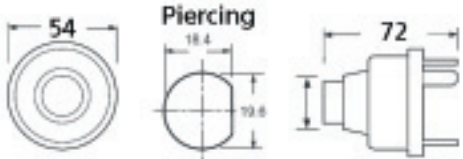
IGNITION SWITCHES – PRODUCT SPECIFICATION

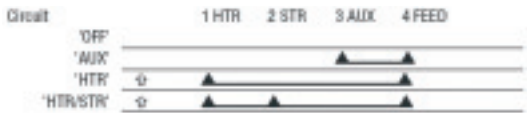
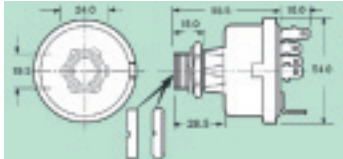

PART NO.	DESCRIPTION	VOLTAGE	FINISH	KEY	POSITIONS	PIERCING BASE	DIAGRAM CIRCUIT
<b>128SA CONTINUED</b>							
39427	128SA 	12v 24v	CRONAK	K1	4	  <p>Circuit: 'OFF', 'AUX', 'AUX/HTR', 'AUX/HTR/STR'</p>  <p>Max Current (1)(2)(3) 10 A/- 15/7.5 A 16/5 A</p>	
39798	128SA 	12v 24v	CRONAK	K3	4	  <p>Circuit: 'STP', 'OFF', 'AUX', 'AUX/STR'</p>  <p>Max Current (1)(2)(3) 10 A/- 16/5 A</p>	
54033527	128SA 	12v 24v	NEOPRENE	K1	4	  <p>Circuit: 'OFF', 'AUX', 'HTR', 'HTR/STR'</p>  <p>Max Current (1)(2)(3) 15/7.5 A 16/5 A 10 A/-</p>	
 <p>K1 Order lock and keys separately, standard lock and keys part no. 54018732 or unique lock and keys part no. 54395731.                  K2 Replacement lock and keys part no. 54318732.                  K3 Replacement keys part no. 54324157.                  K4 Order levers separately part no. 54380037.</p>							



PART NO.	DESCRIPTION		PART NO.	DESCRIPTION	
<b>KEYS</b>					
54316695	Keys		54316732	Keys	
54316731	Keys		54324157	Keys	
<b>STEERING LOCK</b>					
SSB300	Steering Lock		SSB303	Steering Lock	
SSB301	Steering Lock		SSB304	Steering Lock	
SSB302	Steering Lock		SSB305	Steering Lock	
<b>SWITCH ACCESSORY</b>					
SPB501	Switch Accessory		31270	Switch Accessory	
30810	Switch Accessory		35327	Switch Accessory	

IGNITION SWITCHES – PRODUCT SPECIFICATION





## Relay Switches

Application List

Page 3.82

Product Specification

Page 3.94

# 3

# Relay Switches



MODEL	TYPE	FUNCTION	ENGINE INFO	CC	YEAR	PART NO.
<b>AC</b>						
428	Solenoid	4ST		7016	1969-74	SRB335
<b>ALLIS CHALMERS {US}</b>						
5000 Combine	Solenoid	2ST		5800	1969-72	SRB319
Super 'A' Combine	Solenoid	2ST		3860	1969-72	SRB319
<b>ASTON MARTIN</b>						
DB6	Solenoid	4ST		3995	1969-71	SRB341
DBS V8	Solenoid	4ST		5340	1969-71	SRB335
DBS V8	Solenoid	4ST		5340	1969-71	SRB341
DBS, 6 GT, 6 Vantage	Solenoid	4ST		3995	1969-71	SRB335
DBS, 6 GT, 6 Vantage	Solenoid	4ST		3995	1969-71	SRB341
<b>AUDI</b>						
100 (III) 1.8, Quattro	Fuelling Relay		PH	1781	10/85-07/87	FDB509
100 (III) 1.8, Quattro, Avant	Fuelling Relay		PH	1781	04/85-07/88	FDB508
100 (III) 2.2 Quattro, Turbo	Fuelling Relay		HX, KV, KU, RX	2226	10/84 -12/87	FDB510
100 Avant (II) 2.2 5S	Fuelling Relay		WC, WE	2144	08/81-82	FDB510
100 Avant (III) 2.0	Fuelling Relay		KP	1994	08/84-08/86	FDB509
100 Avant (III) 2.0	Fuelling Relay		KP, RT	1994	08/84-12/87	FDB510
100 Avant (III) 2.2 Cat, Turbo	Fuelling Relay		HX, KV	2226	08/86-12/87	FDB510
100 Avant (III) 2.2 Quattro, Turbo	Fuelling Relay		KU	2226	01/88-11/90	FDB509
100 Avant (III) 2.2, Turbo	Fuelling Relay		WC	2144	1983-07/84	FDB510
100 Avant (III) 2.3	Fuelling Relay		KZ	2309	1985-09/86	FDB510
200 (II) 2.2E	Fuelling Relay		KU	2226	01/85-07/85	FDB510
200 2.2 5E	Fuelling Relay		WC	2144	10/79-09/82	FDB510
200 2.2 5T Turbo	Fuelling Relay		WJ	2144	10/79-09/82	FDB509
80 (II) 1.6	Fuelling Relay		(55 kW, 63 kW) YH	1588	09/78-09/80	FDB510
80 (II) 1.8 Quattro, GTE	Fuelling Relay		DZ	1781	08/85-08/86	FDB511
80 (II) 1.8, 1.8 E/SE/GTE	Fuelling Relay		JN	1781	05/84-05/86	FDB509
80 (II) 1.8, 1.8E, GTE	Fuelling Relay		JN	1781	1986	FDB508
80 (II) 2.0	Fuelling Relay		JL, JS, SK	1994	09/83-09/86	FDB510
80 (II) 2.2 5E	Fuelling Relay		WE	2144	08/81-08/83	FDB510
80 (III) 1.8, 1.8 E/S/SE 1.8 Quattro, Coupe, Cabriolet	Fuelling Relay		JN, DZ	1781	05/86-09/91	FDB508
80 1.6	Fuelling Relay		YK	1588	09/78-08/79	FDB510
90 (II) 2.0	Fuelling Relay		PS	1994	04/87-07/91	FDB509
90 (II) 2.2 Quattro	Fuelling Relay		KV	2226	04/87-09/91	FDB509
90 2.0	Fuelling Relay		PS	1994	1987	FDB509
90 2.0	Fuelling Relay		JS, SK	1994	08/85-09/86	FDB510
90 2.2 Quattro	Fuelling Relay		KV	2226	1987	FDB509
90 2.2 Quattro	Fuelling Relay		JT	2226	08/85-03/87	FDB510
All Models	Fuelling Relay		1.9TDi		10/88-11/96	FDB516
Coupe (II) 2.2 Quattro	Fuelling Relay		KV	2226	11/88-07/91	FDB509
Coupe (II) 2.2E	Fuelling Relay		KV	2226	11/88-91	FDB509
Coupe 1.8 Quattro	Fuelling Relay		DZ	1781	03/85-07/85	FDB510
Coupe 2.0 GT 5E	Fuelling Relay		JS, SK	1994	10/85-07/86	FDB509
Coupe 2.2 GT	Fuelling Relay		KX	2226	08/87-04/88	FDB510
Coupe 2.2 Quattro	Fuelling Relay		JT, KV	2226	12/84-12/87	FDB510
<b>AVELING BARFORD</b>						
500, 600 Super Grader	Solenoid	2ST		11094	1977-79	SRB321
Beaver 25 Cwt Dumper	Solenoid	4ST			1970-76	SRB351
Bison Mk I Dumper	Solenoid	4ST			1970-76	SRB351
Centaur 35, 40, 50	Solenoid	4ST			1977-79	SRB351
FK Range	Solenoid	4ST	Ford 2704E	5948	1973-76	SRB351
FK Range	Solenoid	4ST	Ford 2714E, 2715E	6220	1973-76	SRB351
FK Range	Solenoid	4ST	Leyland 400		1973-76	SRB351
FK Range	Solenoid	4ST	Perkins 6.354	5800	1973-76	SRB351
FL1 Range Loader	Solenoid	4ST	Leyland 680	11094	1973-76	SRB351
FL1 Range Loader	Solenoid	4ST	Rolls-Royce C6NFR		1973-76	SRB351
GA3 Road Roller	Solenoid	2ST			1969-76	SRB319
GR Road Roller	Solenoid	2ST		2500	1969-76	SRB319
MG Grader	Solenoid	2ST		6540	1977-79	SRB321
PM20 Road Roller	Solenoid	4ST			1977-78	SRB351
PR15 Road Roller	Solenoid	4ST	Ford 2711E	4150	1977-78	SRB351
PR15 Road Roller	Solenoid	4ST	Perkins 4.236	3860	1977-78	SRB351
SL 2 Dump Truck	Solenoid	2ST		9783	1969	SRB321
SL 3 Dump Truck	Solenoid	4ST		11094	1971-76	SRB351
SN Dump Truck	Solenoid	2ST			1969	SRB321





MODEL	TYPE	FUNCTION	ENGINE INFO	CC	YEAR	PART NO.
<b>AVEILING BARFORD CONTINUED</b>						
SR1 Dump Truck	Solenoid	2ST	Leyland 400, 401		1969	SRB321
SR1 Dump Truck	Solenoid	2ST	Rolls-Royce C4NFR		1969	SRB321
SR2 Dump Truck	Solenoid	2ST	Leyland 400, 401		1969	SRB321
SR2 Dump Truck	Solenoid	2ST	Rolls-Royce C4NFR		1969	SRB321
SR2 Dump Truck	Solenoid	4ST			1970-76	SRB351
SW3 Dump Truck	Solenoid	4ST			1970-76	SRB351
SY4, SY5, SY6, SY7 Badger Dump Truck	Solenoid	4ST	Ford 2711E, 2712E, 2713E		1970-76	SRB351
SY4, SY5, SY6, SY7 Badger Dump Truck	Solenoid	4ST	Perkins 4.236	3860	1970-76	SRB351
TS 200 Tractor Loading Shovel	Solenoid	4ST	Ford 2715E	6220	1977-78	SRB351
TS 200 Tractor Loading Shovel	Solenoid	4ST	Perkins 6.354	5800	1977-78	SRB351
TS 230 Tractor Loading Shovel	Solenoid	4ST			1977-78	SRB351
TS 350 Tractor Loading Shovel	Solenoid	4ST		11094	1977-78	SRB351
TS 350P, 500P Tractor Loading Shovel	Solenoid	4ST			1977-78	SRB351
VP Vibratory Road Roller	Solenoid	2ST	Ford 2704C, E, 2714E		1969	SRB319
VR3 Vibratory Road Roller	Solenoid	2ST	Ford 2704C, E, 2714E		1969	SRB319
VR3 Vibratory Road Roller	Solenoid	2ST	Lister-Petter, Ruston 2YWA		1969	SRB319
VS Road Roller	Solenoid	2ST	Ford 2704C, E, 2714E		1969	SRB319
VS Road Roller	Solenoid	2ST	Perkins	5800	1969	SRB319
<b>BEDFORD</b>						
CF220 Petrol	Solenoid	4ST		1800	1969-81	SRB335
CF230 Diesel	Solenoid	4ST		2300	1980-81	SRB325
CF230 Petrol	Solenoid	4ST		1800	1969-81	SRB335
CF250 Diesel	Solenoid	4ST		2300	1980-81	SRB325
CF250 Petrol	Solenoid	4ST		2300	1969-81	SRB335
CF280 Diesel	Solenoid	4ST		2300	1980-81	SRB325
CF280 Petrol	Solenoid	4ST		2300	1969-81	SRB335
CF340 Petrol	Solenoid	4ST		2300	1969-81	SRB335
CF350 Diesel	Solenoid	4ST		2300	1980-81	SRB325
CF350 Petrol	Solenoid	4ST		2300	1969-81	SRB335
Chevanne	Solenoid	4ST		1256	1976-79	SRB335
HA Van 6 Cwt	Solenoid	4ST		1159, 1256	1974-83	SRB325
M1120 Special Appliance 4x4	Solenoid	4ST			1971-87	SRB335
TJ 214, 220, 300, 330	Solenoid	4ST			1972-87	SRB325
TJ 214, 220, 300, 330	Solenoid	2ST			1974	SRB319
TK 1000 (KE) 330	Solenoid	4ST			1976-86	SRB325
TK 1260 (KG) 300, 330	Solenoid	4ST			1976-86	SRB325
TK 1260 (KG) 500	Solenoid	4ST			1976-86	SRB325
TK 1630 (KFA) 330	Solenoid	4ST			1976-86	SRB325
TK 570 (KB, KC) 214, 220	Solenoid	4ST			1976-86	SRB325
TK 750 (KC) 214, 220	Solenoid	4ST			1976-86	SRB325
TK 860 (KD) 330	Solenoid	4ST			1976-86	SRB325
<b>CASE INTERNATIONAL</b>						
1200 Tractor, (Selectomatic)	Solenoid	4ST			1969-71	SRB341
2276 Tractor (Skid-Steer)	Solenoid	4ST			1971-80	SRB325
354 Tractor	Solenoid	4ST			1973-82	SRB325
3B 100 A Excavator	Solenoid	4ST			1975-76	SRB325
444 Tractor	Solenoid	4ST			1973-82	SRB325
500 Payloader	Solenoid	4ST			1975-78	SRB325
500 Payloader (LPG)	Solenoid	4ST			1975-78	SRB325
634 Tractor	Solenoid	2ST			1969-70	SRB319
634 Tractor	Solenoid	4ST			1971-72	SRB325
770 Tractor (Selectomatic)	Solenoid	4ST			1969-71	SRB341
880 Tractor (Selectomatic)	Solenoid	4ST			1969-71	SRB341
990 Tractor	Solenoid	4ST			1969-71	SRB341
995 Tractor	Solenoid	4ST			1969-71	SRB341
996 Tractor	Solenoid	4ST			1969-71	SRB341
B 125 A Excavator	Solenoid	2ST			1969-70	SRB319
B 125 A Excavator	Solenoid	4ST			1971-76	SRB325
BTD 6 Crawler Tractor	Solenoid	2ST		3860	1969-70	SRB319
BTD 6 Crawler Tractor	Solenoid	4ST		3860	1971-74	SRB325
BUD264, 281 Power Unit	Solenoid	2ST			1969-70	SRB319
BUD264, 281 Power Unit	Solenoid	4ST			1971-75	SRB325
H 25 B Payloader	Solenoid	4ST			1969-75	SRB325
H 30 B Payloader	Solenoid	4ST	BD281		1971-75	SRB325
H 50 B Payloader	Solenoid	2ST		5800	1969-70	SRB319
H 65 B Payloader	Solenoid	2ST		5800	1969-70	SRB319
H 65 B Payloader	Solenoid	4ST		5800	1971-73	SRB325



MODEL	TYPE	FUNCTION	ENGINE INFO	CC	YEAR	PART NO.
<b>CASE INTERNATIONAL CONTINUED</b>						
TD 5 Crawler Tractor	Solenoid	2ST			1969-70	SRB319
TD 5 Crawler Tractor	Solenoid	4ST			1971-75	SRB325
TD 6, A Crawler Tractor	Solenoid	2ST			1969-70	SRB319
TD 6, A Crawler Tractor	Solenoid	4ST			1971-76	SRB325
TD 8 A Crawler Tractor	Solenoid	2ST		3917	1969-70	SRB319
TD 8 A Crawler Tractor	Solenoid	4ST		3917	1971-83	SRB325
TD 8 B Crawler Tractor	Solenoid	2ST		3917	1969-70	SRB319
TD 8 B Crawler Tractor	Solenoid	4ST		3917	1971-83	SRB325
<b>CITROËN</b>						
CX 25 GTi	Fuelling Relay		M 25/659	2500	1983-89	FDB505
CX 25 GTi (Cat)	Fuelling Relay		M 25/668	2500	1986-89	FDB505
CX 25 GTi Turbo, 2	Fuelling Relay		M 25/662	2500	1984-89	FDB505
CX 25i, Estate/Break	Fuelling Relay		M 25/659	2500	1983-91	FDB505
XM (Facelift) 2.0i 16v	Fuelling Relay		XU10J4	1998	1994 >>	FDB506
XM 2.0i, Turbo	Fuelling Relay		XU10J2, XU10J2TE	1998	1989-94	FDB506
<b>CONVEYANCER</b>						
TC4 Fork Lift	Solenoid	4ST		3300	1973-83	SRB325
TC5 Fork Lift, TC6 Fork Lift	Solenoid	4ST			1973-83	SRB325
TC7 Fork Lift	Solenoid	4ST		3860	1973-83	SRB325
<b>DENNIS EAGLE</b>						
NT, NX, NY	Solenoid	2ST			1973-78	SRB321
<b>DENNIS SPECIALIST VEHICLES</b>						
Fire Engine: D Range	Solenoid	4ST		4235	1972-76	SRB351
Fire Engine: F Range	Solenoid	4ST			1972-79	SRB351
Fire Engine: R Range	Solenoid	4ST			1978-79	SRB351
<b>FERRARI</b>						
Mondial 3.2 Quattrovalvole	Fuelling Relay		F105 C (V8)	3185	1985-89	FDB505
<b>FIAT</b>						
Croma 2.0 i.e 16v, 2.0i.e, Turbo ie	Fuelling Relay		DOHC	1995	1986-91	FDB505
Croma (II) 2.0 i.e 16v, 2.0i.e, Turbo ie	Fuelling Relay		DOHC	1995	1991-96	FDB505
Uno (Ilt) Turbo ie	Fuelling Relay			1372	1989-97	FDB505
Uno Turbo ie	Fuelling Relay			1299	1985-90	FDB505
<b>FODEN</b>						
FC17, FC20 4x2 Dump Truck	Solenoid	4ST			1971-78	SRB351
FC27, FC27A 6x4 Dump Truck	Solenoid	4ST			1971-78	SRB351
FC35 4x2, FC35A 6x4 Dump Truck	Solenoid	4ST			1971-78	SRB351
FL17 4x2 Dump Truck	Solenoid	4ST		11094	1971-78	SRB351
S10 G2010 Eight-Wheeler Haulmaster	Solenoid	4ST		10450	1978-82	SRB351
S10 G2010 Tractor Unit Fleetmaster	Solenoid	4ST		10450	1978-82	SRB351
S90 C2509 Tractor Unit Haulmaster	Solenoid	4ST		14000	1977-78	SRB351
S90 R2709 Tractor Unit Haulmaster	Solenoid	4ST		12170	1977-78	SRB351
S95 C2995 Tractor Unit Fleetmaster	Solenoid	4ST		14000	1977-79	SRB351
S95 R2995 Tractor Unit Fleetmaster	Solenoid	4ST		12170	1977-79	SRB351
Universal	Solenoid	4ST			1977-78	SRB351
<b>FORD</b>						
Capri II All models OHV	Solenoid	4ST			1975-78	SRB333
Capri III 2.8i, Turbo V6	Fuelling Relay	K Jetronic injection			1981-87	FDB503
Cortina II All models	Solenoid	4ST			1967-70	SRB335
Cortina III 1.3, 1.6 OHV	Solenoid	4ST			1970-76	SRB333
Cortina IV 1.3 OHV	Solenoid	4ST			1976-81	SRB333
Escort 1.1 1.3 1.6 OHV	Solenoid	4ST			1969-72	SRB335
Escort 1.1 1.3 1.6 OHV	Solenoid	4ST			1973-75	SRB333
Escort II 1.1 1.3 1.6 OHV	Solenoid	4ST			1975-80	SRB333
Escort III 1.6i, Turbo CVH	Fuelling Relay	K Jetronic injection			1982-86	FDB502
Granada II 2.8i V6	Fuelling Relay				1977-82	FDB503
Granada III 1.8i, 2.0i, 2.4i, 2.8i V6, 2.9i V6	Fuelling Relay				1985-92	FDB503
Orion 1.6i CVH	Fuelling Relay	K Jetronic injection			1983-90	FDB502
Serria 2.0i, 2.0i 4x4	Fuelling Relay				1987-93	FDB503
Serria 2.0i, 2.8i V6, 2.9i V6	Fuelling Relay				1985-93	FDB503



MODEL	TYPE	FUNCTION	ENGINE INFO	CC	YEAR	PART NO.
<b>FORD LCV</b>						
Transit 1.6 1.7 V4 2.0 V4 2.4D	Solenoid	4ST			1972-73	SRB325
Transit 1.6 1.7 V4 2.0 V4 2.4D	Solenoid	4ST			1974-78	SRB333
<b>FORD TRACTORS</b>						
231 Tractor	Solenoid	4ST			1971-73	SRB325
231 Tractor	Solenoid	4ST			1974-78	SRB333
<b>IVECO FORD</b>						
A Series A407 (35 cwt) 2.0	Solenoid	4ST		1996	1973-78	SRB333
A Series A409 (35 cwt) 3.5 Diesel	Solenoid	4ST		3540	1973-83	SRB333
A Series A410 (35 cwt) 3.0	Solenoid	4ST		2994	1973-83	SRB333
A Series A506 (2 Ton.) 2.4 Diesel	Solenoid	4ST		2360	1973-83	SRB333
A Series A507 (2 Ton.) 2.0	Solenoid	4ST		1996	1973-78	SRB333
A Series A509 (2 Ton.) 3.5 Diesel	Solenoid	4ST		3540	1973-83	SRB333
A Series A510 (2 Ton.) 3.0	Solenoid	4ST		2994	1973-83	SRB333
A Series A606 (3 Ton.) 2.4 Diesel	Solenoid	4ST		2360	1973-83	SRB333
A Series A609 (3 Ton.) 3.5 Diesel	Solenoid	4ST		3540	1973-83	SRB333
A Series A610 (3 Ton.) 3.0	Solenoid	4ST		2994	1973-83	SRB333
D Series D0507, 0510, 0513, 0607, 0610	Solenoid	4ST			1971-80	SRB351
D Series D0707, 0710, 0807, 0810	Solenoid	4ST			1971-80	SRB351
D Series D0907, 0910, 0911	Solenoid	4ST			1971-80	SRB351
D Series D1000	Solenoid	4ST			1969-72	SRB351
D Series D1010, 1110	Solenoid	4ST		5948	1971-80	SRB351
D Series D1111, 1114	Solenoid	4ST			1975-80	SRB351
D Series D1210, 1211, 1311, 1314	Solenoid	4ST			1971-80	SRB351
D Series D1411, 1414	Solenoid	4ST			1971-80	SRB351
D Series D1610	Solenoid	4ST		5948	1978-80	SRB351
D Series D1614	Solenoid	4ST		5945	1971-80	SRB351
D Series D1617, 1618	Solenoid	4ST			1974-80	SRB351
D Series D1710, 1711, 1911	Solenoid	4ST			1978-80	SRB351
D Series D200, D300 (240, 255, 330)	Solenoid	4ST			1969-71	SRB351
D Series D2014, 2114, 2414, 2417, 2418	Solenoid	4ST			1978-80	SRB351
D Series D400 (240, 255, 330)	Solenoid	4ST			1969-71	SRB351
D Series D500 (240, 255, 330)	Solenoid	4ST			1969-71	SRB351
D Series D550 (255)	Solenoid	4ST		4162	1969-71	SRB351
D Series D600, 700, 750, 800 (300), (330)	Solenoid	4ST			1969-71	SRB351
D Series D800, D900 (360)	Solenoid	4ST		5945	1969-71	SRB351
D Series DA1007 (Artic)	Solenoid	4ST		4162	1971-78	SRB351
D Series DA1610, 1710, 1911 (Artic)	Solenoid	4ST			1971-80	SRB351
D Series DA2014, 2114 (Artic)	Solenoid	4ST		5945	1971-80	SRB351
D Series DA2417 (Artic)	Solenoid	4ST		8849	1973-80	SRB351
D Series DA2418 (Artic)	Solenoid	4ST		8263	1970-80	SRB351
D Series DA2817 (Artic)	Solenoid	4ST		8849	1973-80	SRB351
D Series DA2818 (Artic)	Solenoid	4ST		8263	1970-80	SRB351
D Series DT1400, 1500, 1700 (Six Wheeler)	Solenoid	4ST			1969-71	SRB351
D Series DT1711, 2014 (Six Wheeler)	Solenoid	4ST			1971-78	SRB351
D Series DT2214 (Six Wheeler)	Solenoid	4ST		5945	1971-75	SRB351
D Series DT2414 (Six Wheeler)	Solenoid	4ST		5945	1975-78	SRB351
D Series DT2417, 2418 (Six Wheeler)	Solenoid	4ST		8849	1973-78	SRB351
D Series DT550, 800 (Six Wheeler)	Solenoid	4ST			1965-72	SRB351
K150 (N/C) 1.5 Ton (3.3), (3.9 Diesel)	Solenoid	4ST			1969-75	SRB325
K200, 220 (N/C) 2 Ton (3.3), (3.9 Diesel)	Solenoid	4ST			1969-75	SRB325
K300 (N/C) 3 Ton (3.3), (4.0 Diesel)	Solenoid	4ST			1969-75	SRB325
K400 (N/C) 4 Ton (3.3), (4.0 Diesel)	Solenoid	4ST			1969-75	SRB325
K500 (N/C) 5 Ton (3.3), (4.0 Diesel), (4.9), (5.4 Diesel)	Solenoid	4ST			1969-75	SRB325
K600 (N/C) 6 Ton (4.9), (5.4 Diesel)	Solenoid	4ST			1969-75	SRB325
K700 (N/C) 7 Ton (4.9), (5.4 Diesel)	Solenoid	4ST			1969-75	SRB325
K750 (N/C) 7.5 Ton (4.9), (5.4 Diesel)	Solenoid	4ST			1969-75	SRB325
R1010, 1011 (PSV) Coach Chassis	Solenoid	4ST			1970-85	SRB325
R1014, 1015, 1111 (PSV) Coach Chassis	Solenoid	4ST			1970-85	SRB325
R1114, 1115 (PSV) Coach Chassis	Solenoid	4ST		5945	1970-85	SRB325
<b>JAGUAR (DAIMLER)</b>						
XJ6 2.8	Solenoid	4ST		2792	1969-73	SRB325
<b>JCB</b>						
6C, D Excavator	Solenoid	2ST		5800	1969-73	SRB319
7B, 7C, 8C, 8D Excavator	Solenoid	2ST		5800	1969-73	SRB319
Chaseside SL1500 F, L Shovel Loader	Solenoid	2ST			1969-70	SRB319



MODEL	TYPE	FUNCTION	ENGINE INFO	CC	YEAR	PART NO.
<b>JCB CONTINUED</b>						
Chaseside SL1750 L Shovel Loader	Solenoid	2ST			1969-70	SRB321
Chaseside SL1750 P Shovel Loader	Solenoid	2ST		5800	1970-73	SRB321
<b>JENSEN</b>						
Interceptor Mk II, FF	Solenoid	4ST		6276	1970-71	SRB335
Interceptor Mk III, SP	Solenoid	4ST		7212	1972-76	SRB335
<b>JONES CRANES</b>						
Zircon Crane	Solenoid	2ST	(Bedford, Perkins)		1971-74	SRB319
<b>LDV</b>						
200, 350, 400	Relay	Wiper Delay Timer Relay			02/88-11/95	SCB316
Sherpa 185	Solenoid	4ST			1974-78	SRB325
Sherpa 215	Solenoid	4ST			1974-78	SRB325
Sherpa 240	Solenoid	4ST			1974-78	SRB325
<b>LEYLAND DAF</b>						
Big J4 4-Wheel (6.6L, 8.8L, 10.5L, 12.2L)	Solenoid	4ST		10450	1970-77	SRB351
Big J4T 4-Wheel Tractor Unit	Solenoid	4ST			1970-77	SRB351
Big J6 6-Wheel, J8 8-Wheel (8.2L, 9.6L)	Solenoid	4ST			1970-77	SRB351
Boxer BX1000 Truck	Solenoid	4ST	(24 V)	5655	1974-77	SRB346
Boxer BX1200 Truck	Solenoid	4ST	(24 V)	5655	1974-77	SRB346
Boxer BX1300 Truck	Solenoid	4ST	(24 V)	5655	1974-77	SRB346
Boxer BX1425	Solenoid	4ST	(24 V)	5655	1974-77	SRB346
Boxer BX1450	Solenoid	4ST	(24 V)	5655	1975-77	SRB346
Boxer BX1600 Truck (Perkins)	Solenoid	4ST	(24 V)	5800	1974-77	SRB346
Boxer BX16TA Tractor Unit	Solenoid	4ST	(24 V)	5655	1974-77	SRB346
Boxer BX16TF Tractor Unit	Solenoid	4ST	(24 V)	5655	1974-77	SRB346
Boxer BX18TF Tractor Unit	Solenoid	4ST	(24 V)	5800	1974-77	SRB346
Boxer BX19TA, TF Tractor Unit	Solenoid	4ST	(24 V)	5800	1974-77	SRB346
Boxer BX20TF Tractor Unit	Solenoid	4ST	(24 V)	5655	1974-77	SRB346
Chieftain CH40.13A, 13B, 13C, 13D	Solenoid	4ST		6540	1978-81	SRB346
Chieftain CH40.19C	Solenoid	4ST		6540	1978	SRB346
Chieftain CH40.20A, CH40.20B	Solenoid	4ST		6540	1978-01/79	SRB346
Chieftain CH40.20C, 20D	Solenoid	4ST		6540	1978-81	SRB346
Chieftain CH41.13A, B	Solenoid	4ST		6540	1978-10/79	SRB346
Chieftain CH41.13C	Solenoid	4ST		6540	1978-10/79	SRB346
Chieftain CH41.19ATR	Solenoid	4ST		6540	1978-81	SRB346
Clydesdale 2CD40.16D	Solenoid	4ST		6540	06/79-81	SRB346
Clydesdale 2CD41.16D	Solenoid	4ST		6540	06/79-81	SRB346
Clydesdale 2CD41.24D	Solenoid	4ST		6540	06/79-81	SRB346
Clydesdale E2CD40.16, 41.24	Solenoid	4ST			1978-81	SRB346
Clydesdale ECD40.14, ECD41.14	Solenoid	4ST			1978-81	SRB346
Constructor 24.15 6x4 Tipper	Solenoid	4ST		6540	11/81-04/86	SRB351
Constructor 24.17 6x4 Tipper	Solenoid	4ST		6540	09/84-02/89	SRB351
Constructor 24.20 6x4 Tipper	Solenoid	4ST		8250	1985-10/90	SRB351
Constructor 24.21 6x4 Tipper	Solenoid	4ST		11100	04/81-05/89	SRB351
Constructor 24.23 6x4 Tipper	Solenoid	4ST		11100	02/85-05/89	SRB351
Constructor 30.21 8x4 Tipper	Solenoid	4ST		11100	01/80-05/84	SRB351
Constructor 30.23 8x4 Tipper	Solenoid	4ST		10450	10/82-11/86	SRB351
Constructor 30.25 8x4 Tipper	Solenoid	4ST		10013	10/80-09/90	SRB351
Constructor 30.26 8x4 Tipper	Solenoid	4ST			12/84-10/90	SRB351
Constructor 30.26 8x4 Truck (Leyland)	Solenoid	4ST		11100	12/84-03/89	SRB351
Constructor 30.27 8x4 Tipper / Truck (Perkins Eagle)	Solenoid	4ST		12170	11/86-11/90	SRB351
Constructor 30.30 8x4 Tipper	Solenoid	4ST		12170	03/87-10/90	SRB351
Constructor 30.30 8x4 Truck	Solenoid	4ST		12170	03/87-10/90	SRB351
EA 345 Van (2.5), Diesel	Solenoid	4ST		2520	1973-79	SRB325
EA 350 Van (2.5), Diesel	Solenoid	4ST		2520	1973-79	SRB325
EA 420 Van (2.5)	Solenoid	4ST		2520	1973-79	SRB325
EA 420 Van (2.5) Diesel	Solenoid	4ST		2520	1973-79	SRB325
EA 440 Van (2.5), Diesel	Solenoid	4ST		2520	1973-79	SRB325
FG 350 (2.2)	Solenoid	4ST		2199	1973-74	SRB325
FG 350 (2.8) Diesel	Solenoid	4ST		2788	1973-74	SRB325
FG 350 Truck (2.5)	Solenoid	4ST		2520	1974-79	SRB325
FG 350 Truck (2.5) Diesel	Solenoid	4ST		2520	1973-79	SRB325
FG 350 Truck (4.0)	Solenoid	4ST			1973-79	SRB325
FG 420 Truck (2.2)	Solenoid	4ST		2199	1973-74	SRB325
FG 420 Truck (2.5)	Solenoid	4ST		2520	1974-79	SRB325

RELAY SWITCHES – APPLICATION LIST



MODEL	TYPE	FUNCTION	ENGINE INFO	CC	YEAR	PART NO.
<b>LEYLAND DAF CONTINUED</b>						
FG 420 Truck (2.5) Diesel	Solenoid	4ST		2520	1973-79	SRB325
FG 420 Truck (2.8) Diesel	Solenoid	4ST			1973-74	SRB325
FG 420 Truck (4.0)	Solenoid	4ST			1973-79	SRB325
FG 550 Truck (3.8) Diesel	Solenoid	4ST		3770	1973-79	SRB325
FG 550 Truck (4.0)	Solenoid	4ST		3993	1973-74	SRB325
FG 700 Truck (3.8) Diesel	Solenoid	4ST		3770	1973-79	SRB325
FG 700 Truck (4.0)	Solenoid	4ST		3993	1973-74	SRB325
FG 900 Truck (4.0), (5.7) Diesel	Solenoid	4ST			1973-74	SRB325
J4 180 1500 Diesel, 1600	Solenoid	4ST		1489	1969-71	SRB325
J4 180 1500 Diesel, 1600	Solenoid	4ST		1489	1972-74	SRB335
J4 190 1500 Diesel, 1600	Solenoid	4ST		1489	1969-71	SRB325
J4 190 1500 Diesel, 1600	Solenoid	4ST		1489	1972-74	SRB335
J4 200 1500 Diesel	Solenoid	4ST		1489	1969-71	SRB325
J4 200 1500 Diesel	Solenoid	4ST		1489	1972-74	SRB335
JU 250, JU 250 Diesel	Solenoid	4ST		1622	1969-71	SRB325
JU 250, JU 250 Diesel	Solenoid	4ST		1622	1972-74	SRB335
Landtrain 19.21, 19.28	Solenoid	4ST		12470	1980-90	SRB351
Landtrain 19.24, 30.21	Solenoid	4ST		12470	1980-90	SRB351
Landtrain 30.24, 30.29	Solenoid	4ST		14000	1980-90	SRB351
Marathon 2MTC34.25F Tractor Unit	Solenoid	4ST		14000	1973-80	SRB346
Marathon 2MTC38.29F Tractor Unit	Solenoid	4ST		14000	10/78-01/79	SRB346
Marathon 2MTL38.25F Tractor Unit	Solenoid	4ST		12473	07/78-04/79	SRB346
Marathon 2MTL38.28F Tractor Unit	Solenoid	4ST		12473	01/79-04/79	SRB346
Marathon 2MTL38.28FS Tractor Unit	Solenoid	4ST		12473	05/76-10/77	SRB351
Marathon 2MTR38.26F Tractor Unit	Solenoid	4ST		12170	05/78-12/80	SRB351
Marathon MTC34.23F Tractor Unit	Solenoid	4ST		14000	07/73-09/80	SRB351
Marathon MTC34.25F Tractor Unit	Solenoid	4ST		14000	07/77-09/80	SRB351
Marathon MTL38.28F Tractor Unit	Solenoid	4ST		12473	01/75-10/77	SRB351
Marathon MTR34.22F Tractor Unit	Solenoid	4ST		12170	05/76-10/77	SRB351
Reiver 2RE41.22C Six Wheeler	Solenoid	4ST		6540	05/78-10/78	SRB346
Reiver 2RE41.24C, 2RE41.24D Six Wheeler	Solenoid	4ST		6540	05/78-01/79	SRB346
Roadtrain 16.25 Tractor Unit (Cummins, Leyland, R-Royce)	Solenoid	4ST		14000	08/80-84	SRB351
Roadtrain 16.28 Tractor Unit	Solenoid	4ST		14000	01/80-84	SRB351
Roadtrain 17.25 Tractor Unit	Solenoid	4ST		14000	05/83-01/84	SRB351
Roadtrain 17.27 Tractor Unit	Solenoid	4ST		12170	11/86-05/90	SRB351
Roadtrain 17.28 Tractor Unit (Cummins L10-250)	Solenoid	4ST		10013	01/87-09/90	SRB351
Roadtrain 17.28 Tractor Unit (Cummins NTE290)	Solenoid	4ST		14000	03/83-01/87	SRB351
Roadtrain 17.28 Tractor Unit (R-Royce)	Solenoid	4ST		12170	03/83-01/84	SRB351
Roadtrain 17.29 Tractor Unit	Solenoid	4ST		12170	02/84-10/86	SRB351
Roadtrain 17.30 Tractor Unit	Solenoid	4ST		12170	08/86-10/90	SRB351
Roadtrain 17.32 Tractor Unit	Solenoid	4ST		14000	11/85-01/89	SRB351
Roadtrain 17.34 Tractor Unit	Solenoid	4ST		10000	10/84-10/86	SRB351
Roadtrain 17.35 Tractor Unit	Solenoid	4ST		12170	08/86-01/89	SRB351
Roadtrain 20.29, 20.32 6x2 Tractor Unit	Solenoid	4ST		10013	01/86-01/89	SRB351
Roadtrain 20.33 6x2 Tractor Unit	Solenoid	4ST		12170	02/88-12/90	SRB351
Roadtrain 20.34 6x2 Tractor Unit	Solenoid	4ST		12170	01/86-89	SRB351
Roadtrain 20.35 6x2 Tractor Unit	Solenoid	4ST		12170	11/86-01/89	SRB351
WF 360 Truck (2.2), (2.5) Diesel	Solenoid	4ST			1973-74	SRB325
WF 420 Truck (2.5), (2.5) Diesel	Solenoid	4ST		2520	1974-75	SRB325
WF 420 Truck (3.8) Diesel	Solenoid	4ST		3770	1973-75	SRB325
WF 830 Truck (4.0)	Solenoid	4ST		3993	1973-74	SRB325
WF 830 Truck (5.7) Diesel	Solenoid	4ST		5655	1973-75	SRB325
<b>LOTUS</b>						
Elan Plus 2, 2S	Solenoid	4ST		1558	1969-70	SRB325
Elan Plus 2, 2S	Solenoid	4ST	(2S)	1558	1970-71	SRB335
Elan Plus 2S 130	Solenoid	4ST		1558	1971-74	SRB335
Elan S4	Solenoid	4ST		1558	1969-70	SRB325
Elan S4	Solenoid	4ST		1558	1970-71	SRB335
Elan Sprint	Solenoid	4ST		1558	1971-73	SRB335
<b>LTI CARBODIES</b>						
FL2 Hire Car 2.25D	Solenoid	4ST		2286	1972-73	SRB325
FL2 Hire Car 2.2D (55, 68 bhp)	Solenoid	4ST		2178	1969-72	SRB325
FX4 Taxi 2.25D	Solenoid	4ST		2286	1972-73	SRB325
FX4 Taxi 2.2D (55/68 bhp)	Solenoid	4ST			1969-72	SRB325



MODEL	TYPE	FUNCTION	ENGINE INFO	CC	YEAR	PART NO.
<b>MATBRO (BRAY)</b>						
530, 534 Loader	Solenoid	2ST			1969-73	SRB319
540, 544 Loader	Solenoid	2ST			1969-77	SRB319
560 Loader	Solenoid	2ST			1969-71	SRB321
562 Loader (Perkins), 566 (Leyland UE 400, 401)	Solenoid	2ST		5800	1970-77	SRB321
566 Loader (Cummins), (Leyland UE 400)	Solenoid	2ST			1969-70	SRB321
572, 577 Loader	Solenoid	2ST			1970-71	SRB321
577 Loader (Leyland), 588	Solenoid	2ST			1971-73	SRB321
<b>MORGAN</b>						
Four Four 1600	Solenoid	4ST		1599	1969-82	SRB325
<b>MUIR-HILL</b>						
M-H 161 Tractor	Solenoid	2ST		8360	1970-76	SRB321
M-H 171 Tractor	Solenoid	2ST		8830	1977	SRB321
<b>OPEL</b>						
Ascona C 1.8i	Fuelling Relay		OHC	1796	09/82-08/86	FDB501
Ascona C 1.8i	Fuelling Relay		OHC	1796	09/86-08/88	FDB504
Ascona C 1.8i	Fuelling Relay		OHC	1796	10/85-08/86	FDB501
Ascona C 2.0 SRI 130, 2.0i,	Fuelling Relay		(SRI) OHC	1998	03/87-08/88	FDB504
Astra A 2.0 GSi 16v, 2.0i	Fuelling Relay			1998	1991-97	FDB504
Astra A Caravan/Estate 2.0 GSi 16v	Fuelling Relay			1998	1993-95	FDB504
Astra A Caravan/Estate 2.0i	Fuelling Relay		DOHC 16v	1998	1991-94	FDB504
Calibra 2.0i 16v (ECOTEC-4)	Fuelling Relay			1998	1994-97	FDB504
Calibra 2.0i 16v 4x4	Fuelling Relay			1998	1990-92	FDB504
Calibra 2.0i, 16v, Turbo 4x4	Fuelling Relay			1998	1990-97	FDB504
Corsa A (Facelift) 1.6 GSi	Fuelling Relay		OHC		1990-93	FDB504
Frontera A (Facelift) 2.0i Sport	Fuelling Relay			1998	1995-98	FDB504
Frontera A 2.0i Sport, 2.3TD, 2.4i	Fuelling Relay		(Not 2.3TD)		1991-95	FDB504
Kadett D 1.8 GTE	Fuelling Relay		OHC	1796	1983-84	FDB501
Kadett E 1.6, 1.6D, 1.6i, 1.6i, 1.7D, TD	Fuelling Relay		(1.6i) OHC	1598	04/89-08/91	FDB504
Kadett E 1.8i, , 1.8 GSi,	Fuelling Relay		(Cat) OHC	1796	09/86-08/91	FDB504
Kadett E 1.8i, , 1.8 GSi,	Fuelling Relay		OHC	1796	1984-08/86	FDB501
Kadett E 2.0i, 2.0 GSi, , 16v	Fuelling Relay		OHC	1998	09/86-89	FDB504
Kadett E Cabrio 2.0 GSi, 2.0i	Fuelling Relay		OHC	1998	1987-08/91	FDB504
Kadett E Caravan/Estate 1.6i, 1.6i	Fuelling Relay		OHC	1598	04/89-08/91	FDB504
Manta B 2.0 GT/E, GSi	Fuelling Relay		OHV	1979	09/81-06/88	FDB501
Monza A 2.5i, 3.0i	Fuelling Relay		25E	2490	1983-08/86	FDB501
Monza A 3.0i	Fuelling Relay		6 Cyl	2968	1985-86	FDB501
Omega A 1.8, 1.8i, 2.0i, 2.0i	Fuelling Relay		1.8i, 2.0i (Cat) OHC		1986-92	FDB504
Omega A 2.4i	Fuelling Relay		OHC	2410	09/88-94	FDB504
Omega A 2.6i	Fuelling Relay		OHC 6 Cyl	2594	1990-94	FDB504
Omega A 3.0i	Fuelling Relay		OHC 6 Cyl	2969	1987-94	FDB504
Omega A 3.0i 24v	Fuelling Relay		OHC 6 Cyl 24v	2969	1989-94	FDB504
Omega A Caravan/Estate 2.4i, 2.6i, 3.0i 24v	Fuelling Relay		OHC		1988-94	FDB504
Omega A Caravan/Estate 3.0i	Fuelling Relay		OHC 6 Cyl	2969	1988-94	FDB504
Senator A (Facelift) 2.5i, 3.0i	Fuelling Relay				1984-87	FDB501
Senator A 2.5i, 3.0i	Fuelling Relay		6 Cyl		1983-84	FDB501
Senator B 2.6i	Fuelling Relay		6 Cyl	2594	05/90-94	FDB504
Senator B 3.0i	Fuelling Relay		6 Cyl	2969	09/87-94	FDB504
Senator B 3.0i 24v	Fuelling Relay		6 Cyl	2969	09/89-94	FDB504
Vectra A 1.8, 1.8 4x4, 1.8i, 2.0i, 2.0i, 2.0i 16v	Fuelling Relay			1998	1988-95	FDB504
Vectra A 2.0i 16v 4x4 (150 PS), 2.0i 4x4 (115 PS)	Fuelling Relay		DOHC	1998	1989-93	FDB504
Vectra A 2.0i Turbo 4x4	Fuelling Relay		DOHC 16v	1998	1991-94	FDB504
<b>PEUGEOT</b>						
505 (2.2i)	Fuelling Relay			2165	1992	FDB505
505 (2.2i) GTi	Fuelling Relay			2165	1984-92	FDB505
505 (2.2i) Turbo	Fuelling Relay			2165	1981-88	FDB505
505 (2.2i) Turbo	Fuelling Relay			2165	1984-88	FDB505
<b>RELIANT</b>						
Fox	Solenoid	4ST		848	1983-90	SRB335
Kitten 850, Van	Solenoid	4ST		848	1975-77	SRB325
Kitten 850, Van	Solenoid	4ST		848	1978-83	SRB335
Rebel (FW4) 700	Solenoid	4ST		700	1968-71	SRB325
Rebel (FW4) 750	Solenoid	4ST		748	1971-73	SRB325
Regal (TW7) 21E 700	Solenoid	4ST		700	1969-72	SRB325
Regal (TW7) 21E 750	Solenoid	4ST		748	1972-74	SRB325
Regal (TW7) 700 Van	Solenoid	4ST		700	1969-72	SRB325

MODEL	TYPE	FUNCTION	ENGINE INFO	CC	YEAR	PART NO.
<b>RELIANT CONTINUED</b>						
Regal (TW7) 750 Van	Solenoid	4ST		748	1972-74	SRB325
Rialto 850, Van	Solenoid	4ST		848	1982-95	SRB335
Robin 750, Van	Solenoid	4ST		748	1974-75	SRB325
Robin 850, Van	Solenoid	4ST		848	1975-77	SRB325
Robin 850, Van	Solenoid	4ST		848	1978-81	SRB335
Scimitar 3.0 GTE	Solenoid	4ST		2994	1969-70	SRB325
Scimitar 3.0 GTE	Solenoid	4ST		2994	1971-74	SRB335
TW9B, C Mighty Ant	Solenoid	4ST		1493	1969-76	SRB325
TW9E Mighty Ant	Solenoid	4ST		748	1969-81	SRB325
<b>ROLLS-ROYCE (BENTLEY)</b>						
Camargue	Solenoid	4ST		6750	1975-86	SRB335
Corniche	Solenoid	4ST		6750	1972-86	SRB335
Corniche II	Solenoid	4ST		6750	1987-89	SRB335
Corniche T	Solenoid	4ST		6750	1974-82	SRB335
Phantom VI	Solenoid	4ST		6750	1986-90	SRB335
Phantom VI	Solenoid	4ST		6750	1968-86	SRB335
Silver Shadow	Solenoid	4ST		6750	1970-77	SRB335
Silver Shadow II	Solenoid	4ST		6750	1977-80	SRB335
T1 Series	Solenoid	4ST		6750	1970-77	SRB335
T2 Series	Solenoid	4ST		6750	1977-80	SRB335
<b>ROVER</b>						
45	Relay					SCB314
All Models	Relay	Replaces Rover Yellow Relay				SRB542
Allegro 1100, 1300, 1500, 1750	Solenoid	4ST			1973-75	SRB325
Allegro 1100, 1300, 1500, 1750	Solenoid	4ST	(Cold Climates)		1973-75	SRB335
Allegro 2 1100, 1300, 1500, 1750	Solenoid	4ST	(Cold Climates)		1975-79	SRB335
Allegro 3 1.0, 1.1, 1.3, 1.5, 1.7	Solenoid	4ST	(Cold Climates)		1980-83	SRB335
Allegro II 1100, 1300, 1500, 1750	Solenoid	4ST			1975-79	SRB325
Allegro III 1.0, 1.1, 1.3, 1.5, 1.7	Solenoid	4ST			1980-83	SRB325
Austin 1100, 1300, GT, Countryman	Solenoid	4ST			1966-73	SRB325
Austin-Healey Sprite (Mk 3/4)	Solenoid	4ST		1275	1969	SRB325
Marina 10 cwt Van, Pick-Up	Solenoid	4ST		1275	1973-78	SRB325
Marina 1300	Solenoid	4ST		1275	1971-75	SRB325
Marina 1800	Solenoid	4ST	(TC, Estate)	1798	1971-75	SRB325
Marina 2 1300	Solenoid	4ST		1275	1975-78	SRB325
Marina 2 1500 Diesel	Solenoid	4ST		1489	1975-78	SRB325
Marina 2 1800	Solenoid	4ST		1798	1975-78	SRB325
Marina 3 1.3	Solenoid	4ST		1275	1978-79	SRB325
Marina 3 1.3	Solenoid	4ST		1275	1980	SRB335
Marina 7 cwt Van	Solenoid	4ST			1973-78	SRB325
Marina 7 cwt Van 1.5 Diesel	Solenoid	4ST		1489	1973-78	SRB325
Marina Coupe 1300	Solenoid	4ST		1275	1970-75	SRB325
Marina Coupe 1800, TC	Solenoid	4ST		1798	1971-75	SRB325
Maxi 1500, 1750	Solenoid	4ST		1485	1969-79	SRB325
Metro 1.0 HLE	Solenoid	4ST		998	1980-91	SRB335
Metro 1.1	Solenoid	4ST		1120	1990-95	SRB335
Metro 1.1i	Solenoid	4ST		1120	1990-95	SRB335
Metro 1.3	Solenoid	4ST	(GTa, LE, Sport)	1275	1980-91	SRB335
Metro 1.3 HLE	Solenoid	4ST		1275	1980-91	SRB335
Metro 1.4	Solenoid	4ST		1396	1990-95	SRB335
Metro 1.4 Diesel	Solenoid	4ST		1360	1992-95	SRB335
Metro 1.4 GTi 16v, Cat, 1.4i	Solenoid	4ST		1396	1990-95	SRB335
Metro 1.4i 16v	Solenoid	4ST		1396	1990-95	SRB335
Metro 310 Van 1.0, 1.3	Solenoid	4ST			1982-91	SRB335
MG Metro Turbo	Solenoid	4ST		1275	1982-90	SRB335
MG Midget 1300	Solenoid	4ST		1275	1969-74	SRB325
MG Midget 1500	Solenoid	4ST		1491	1975-80	SRB335
Mini 1/4 Ton Van	Solenoid	4ST			1970-80	SRB325
Mini 1000	Solenoid	4ST		998	1969-92	SRB325
Mini 1300	Solenoid	4ST		1275	1991-94	SRB325
Mini 850	Solenoid	4ST		848	1969-80	SRB325
Mini 95 Van	Solenoid	4ST		998	1981-83	SRB325
Mini Cabriolet 1.3	Solenoid	4ST		1275	1991-94	SRB325
Mini Clubman 1000	Solenoid	4ST		998	1970-73	SRB325
Mini Clubman 1000	Solenoid	4ST	{CA}, {NO}	998	1971-80	SRB335
Mini Clubman 1100	Solenoid	4ST	{CA}, {NO}	1098	1975-80	SRB335



MODEL	TYPE	FUNCTION	ENGINE INFO	CC	YEAR	PART NO.
<b>ROVER CONTINUED</b>						
Mini Clubman 1275 GT	Solenoid	4ST	(Auto)	1275	1970-73	SRB325
Mini Clubman 1275 GT	Solenoid	4ST	{CA}, {NO}	1275	1971-73	SRB335
Mini Cooper S	Solenoid	4ST		1275	1969-70	SRB325
Mini Pick-Up 850, 1000	Solenoid	4ST			1970-83	SRB325
Morris Ital 1.3	Solenoid	4ST		1275	1980-84	SRB335
Morris Minor 1000	Solenoid	4ST		1098	1969-71	SRB325
Rover (800) 820, 820e, 820Se	Fuelling Relay	28RA	(Se) M16e	1994	1986-91	SRB500
Sterling 820e, Se	Fuelling Relay	28RA		1994	1986-91	SRB500
Triumph 1300, TC	Solenoid	4ST		1296	1969-70	SRB325
Triumph 2000	Solenoid	4ST		1998	1969-71	SRB325
Triumph 2500 PI	Solenoid	4ST		2498	1969-71	SRB325
Triumph Dolomite 1300, 1500, 1850 HL	Solenoid	4ST		1296	1976-81	SRB335
Triumph GT6	Solenoid	4ST		1998	1969-70	SRB325
Triumph GT6	Solenoid	4ST		1998	1971-74	SRB335
Triumph Spitfire 1300	Solenoid	4ST		1296	1969-70	SRB325
Triumph Spitfire 1300	Solenoid	4ST		1296	1971-74	SRB335
Triumph Spitfire 1500	Solenoid	4ST		1493	1976-81	SRB335
Triumph Stag	Solenoid	4ST		2997	1972-77	SRB335
Triumph Toledo	Solenoid	4ST		1296	1971-75	SRB335
Triumph TR5	Solenoid	4ST		2498	1969	SRB325
Triumph TR6 PI (125 bhp)	Solenoid	4ST		2498	1969-75	SRB325
Triumph TR6 PI (132/150 bhp)	Solenoid	4ST		2498	1969-75	SRB325
Triumph Vitesse 2 Litre	Solenoid	4ST		1998	1969-71	SRB325
Wolseley 1300	Solenoid	4ST		1275	1968-73	SRB325
Wolseley 18/85, 18/85.5	Solenoid	4ST		1798	1969-72	SRB325
Wolseley 2200 (Princess)	Solenoid	4ST		2227	1975	SRB325
<b>RVI (RTI)</b>						
50 S35 L3 3.5 Ton	Solenoid	4ST		1981	1979-84	SRB335
50 S35 M2 3.5 Ton	Solenoid	4ST		3685	1979-86	SRB335
50 S35 U1, Z2 3.5 Ton	Solenoid	4ST		3860	1979-86	SRB325
50 S35-90, 110 3.5 Ton	Solenoid	4ST		3990	1987-93	SRB325
50 S46 L3 4.5 Ton	Solenoid	4ST		1981	1979-84	SRB335
50 S46 M2, U1, Z2 4.5 Ton	Solenoid	4ST			1979-87	SRB335
50 S46 Z2 4.5 Ton Turbo	Solenoid	4ST		3867	1985-86	SRB325
50 S46-90, 110 4.6 Ton	Solenoid	4ST		3990	1987-93	SRB325
50 S56 M2, U1 5.5 Ton	Solenoid	4ST			1979-87	SRB335
50 S56 U3 5.5 Ton	Solenoid	4ST		3867	1986-87	SRB325
50 S56 Z2 5.5 Ton	Solenoid	4ST		4052	1979-86	SRB325
50 S56-90, 110 5.6 Ton	Solenoid	4ST		3990	1987-93	SRB325
50 S66 M2 6.5 Ton	Solenoid	4ST		3685	1979-87	SRB335
50 S66 U1 6.5 Ton	Solenoid	4ST		3860	1979-87	SRB325
50 S66 U3 6.5 Ton	Solenoid	4ST		3867	1986-87	SRB325
50 S66 Z2 6.5 Ton	Solenoid	4ST		4052	1979-86	SRB325
50 S66-90, 110 6.6 Ton	Solenoid	4ST		3990	1987-93	SRB325
50 S75 U1 7.4 Ton	Solenoid	4ST		3860	1980-87	SRB325
50 S75 U3 7.4 Ton	Solenoid	4ST		3867	1986-87	SRB325
50 S75 Z2 7.4 Ton	Solenoid	4ST		4052	1980-86	SRB325
50 S75-90, 110 7.5 Ton	Solenoid	4ST		3990	1987-93	SRB325
500 K1050 16 Ton 4x2 Rigid, Truck	Solenoid	4ST	(12 V)		1971-75	SRB341
500 K1050 16 Ton 4x2 Rigid, Truck	Solenoid	4ST	(24 V)		1971-75	SRB351
500 K1100 16 Ton 4x2 Rigid	Solenoid	2ST	(12 V)		1969-70	SRB319
500 K1100 16 Ton 4x2 Rigid	Solenoid	2ST	(24 V)		1969-70	SRB321
500 K1100 16 Ton 4x2 Rigid	Solenoid	4ST	(12 V)		1971-74	SRB341
500 K1100 16 Ton 4x2 Rigid	Solenoid	4ST	(24 V)		1971-74	SRB351
500 K1613 16 Ton 4x2 Rigid	Solenoid	2ST	V8.510 (12 V)	8360	1969-70	SRB319
500 K1613 16 Ton 4x2 Rigid	Solenoid	2ST	V8.510 (24 V)	8360	1969-70	SRB321
500 K1613 16 Ton 4x2 Rigid	Solenoid	4ST	V8 (12 V)	8360	1971-77	SRB341
500 K1613 16 Ton 4x2 Rigid	Solenoid	4ST	V8 (24 V)	8360	1971-77	SRB351
500 K2011P, K2211P 20 Ton 6x2 Tractor Unit	Solenoid	2ST	(12 V)	5800	1969-70	SRB319
500 K2011P, K2211P 20 Ton 6x2 Tractor Unit	Solenoid	2ST	(24 V)	5800	1969-70	SRB321
500 K2011P, K2211P 20 Ton 6x2 Tractor Unit	Solenoid	4ST	(12 V)	5800	1971-78	SRB341
500 K2011P, K2211P 20 Ton 6x2 Tractor Unit	Solenoid	4ST	(24 V)	5800	1971-78	SRB351
500 K2213T 22 Ton 6x4 Rigid	Solenoid	2ST	(12 V)	8360	1969-70	SRB319
500 K2213T 22 Ton 6x4 Rigid	Solenoid	2ST	(24 V)	8360	1969-70	SRB321
500 K2213T 22 Ton 6x4 Rigid	Solenoid	4ST	(12 V)	8360	1971-78	SRB341
500 K2213T 22 Ton 6x4 Rigid	Solenoid	4ST	(24 V)	8360	1971-78	SRB351
500 K2413P 24 Ton 6x4 Tractor Unit	Solenoid	2ST	V8.510 (12 V)	8360	1969-70	SRB319
500 K2413P 24 Ton 6x4 Tractor Unit	Solenoid	2ST	V8.510 (24 V)	8360	1969-70	SRB321

RELAY SWITCHES – APPLICATION LIST





MODEL	TYPE	FUNCTION	ENGINE INFO	CC	YEAR	PART NO.
<b>RVI (RTI) CONTINUED</b>						
500 K2413P 24 Ton 6x4 Tractor Unit	Solenoid	4ST	V8 (12 V)	8360	1971-78	SRB341
500 K2413P 24 Ton 6x4 Tractor Unit	Solenoid	4ST	V8.510 (24 V)	8360	1971-78	SRB351
500 K2413R 24 Ton 6x4 Rigid	Solenoid	2ST	V8.510 (12 V)	8360	1969-70	SRB319
500 K2413R 24 Ton 6x4 Rigid	Solenoid	2ST	V8.510 (24 V)	8360	1969-70	SRB321
500 K2413R 24 Ton 6x4 Rigid	Solenoid	4ST	V8 (12 V)	8360	1971-78	SRB341
500 K2413R 24 Ton 6x4 Rigid	Solenoid	4ST	V8 (24 V)	8360	1971-78	SRB351
500 K2413T 24 Ton 6x4 Rigid	Solenoid	2ST	V8.510 (12 V)	8360	1969-70	SRB319
500 K2413T 24 Ton 6x4 Rigid	Solenoid	2ST	V8.510 (24 V)	8360	1969-70	SRB321
500 K2413T 24 Ton 6x4 Rigid	Solenoid	4ST	V8 (12 V)	8360	1971-78	SRB341
500 K2413T 24 Ton 6x4 Rigid	Solenoid	4ST	V8 (24 V)	8360	1971-78	SRB351
500 K2813P 28 Ton 6x4 Tractor Unit	Solenoid	2ST	V8.510 (12 V)	8360	1969-70	SRB319
500 K2813P 28 Ton 6x4 Tractor Unit	Solenoid	2ST	V8.510 (24 V)	8360	1969-70	SRB321
500 K2813P 28 Ton 6x4 Tractor Unit	Solenoid	4ST	V8 (12 V)	8360	1971-78	SRB341
500 K2813P 28 Ton 6x4 Tractor Unit	Solenoid	4ST	V8 (24 V)	8360	1971-78	SRB351
500 K3820D 38 Ton 6x4 Tractor Unit	Solenoid	2ST	(12 V)		1969-70	SRB319
500 K3820D 38 Ton 6x4 Tractor Unit	Solenoid	2ST	(24 V)		1969-70	SRB321
500 K3820D 38 Ton 6x4 Tractor Unit	Solenoid	4ST	(12 V)		1971-78	SRB341
500 K3820D 38 Ton 6x4 Tractor Unit	Solenoid	4ST	(24 V)		1971-78	SRB351
500 K3820P 38 Ton 6x4 Tractor Unit	Solenoid	4ST	(12 V)	11946	1973-76	SRB341
500 K3820P 38 Ton 6x4 Tractor Unit	Solenoid	4ST	(24 V)	11946	1973-76	SRB351
500 K850 4x2 Rigid, Truck	Solenoid	2ST	(12 V)		1969-70	SRB319
500 K850 4x2 Rigid, Truck	Solenoid	2ST	(24 V)		1969-70	SRB321
500 K850 4x2 Rigid, Truck	Solenoid	4ST	(12 V)		1971-78	SRB341
500 K850 4x2 Rigid, Truck	Solenoid	4ST	(24 V)		1971-78	SRB351
500 K950 4x2 Rigid, Truck	Solenoid	2ST	(12 V)		1969-70	SRB319
500 K950 4x2 Rigid, Truck	Solenoid	2ST	(24 V)		1969-70	SRB321
500 K950 4x2 Rigid, Truck	Solenoid	4ST	(12 V)		1971-78	SRB341
500 K950 4x2 Rigid, Truck	Solenoid	4ST	(24 V)		1971-78	SRB351
500 KL500, KL600 Truck	Solenoid	2ST	(12 V)	5800	1969-70	SRB319
500 KL500, KL600 Truck	Solenoid	2ST	(24 V)	5800	1969-70	SRB321
500 KL500, KL600 Truck	Solenoid	4ST	(12 V)	5800	1971-78	SRB341
500 KL500, KL600 Truck	Solenoid	4ST	(24 V)	5800	1971-78	SRB351
500 KP1000 28 Ton 6x2 Tractor Unit	Solenoid	2ST	(12 V)		1969-70	SRB319
500 KP1000 28 Ton 6x2 Tractor Unit	Solenoid	2ST	(24 V)		1969-70	SRB321
500 KP1000 28 Ton 6x2 Tractor Unit	Solenoid	4ST	(12 V)		1971-78	SRB341
500 KP1000 28 Ton 6x2 Tractor Unit	Solenoid	4ST	(24 V)		1971-78	SRB351
500 KP700 20 Ton 4x2 Tractor Unit	Solenoid	2ST	(12 V)		1969-70	SRB319
500 KP700 20 Ton 4x2 Tractor Unit	Solenoid	2ST	(24 V)		1969-70	SRB321
500 KP700 20 Ton 4x2 Tractor Unit	Solenoid	4ST	(12 V)		1971-78	SRB341
500 KP700 20 Ton 4x2 Tractor Unit	Solenoid	4ST	(24 V)		1971-78	SRB351
500 KP850, 950 22 Ton 4x2 Tractor Unit	Solenoid	2ST	(12 V)		1969-70	SRB319
500 KP850, 950 22 Ton 4x2 Tractor Unit	Solenoid	2ST	(24 V)		1969-70	SRB321
500 KP850, 950 22 Ton 4x2 Tractor Unit	Solenoid	4ST	(12 V)		1971-78	SRB341
500 KP850, 950 22 Ton 4x2 Tractor Unit	Solenoid	4ST	(24 V)		1971-78	SRB351
500 KR900 22 Ton 6x2 Rigid	Solenoid	2ST	(12 V)		1969-70	SRB319
500 KR900 22 Ton 6x2 Rigid	Solenoid	2ST	(24 V)		1969-70	SRB321
500 KR900 22 Ton 6x2 Rigid	Solenoid	4ST	(12 V)		1971-78	SRB341
500 KR900 22 Ton 6x2 Rigid	Solenoid	4ST	(24 V)		1971-78	SRB351
500 KT900 22 Ton 6x4 Rigid	Solenoid	2ST	(12 V)		1969-70	SRB319
500 KT900 22 Ton 6x4 Rigid	Solenoid	2ST	(24 V)		1969-70	SRB321
500 KT900 22 Ton 6x4 Rigid	Solenoid	4ST	(12 V)		1971-78	SRB341
500 KT900 22 Ton 6x4 Rigid	Solenoid	4ST	(24 V)		1971-78	SRB351
CE8	Solenoid	2ST	(12 V)		1969-70	SRB319
CE8	Solenoid	2ST	(24 V)		1969-70	SRB321
CE8	Solenoid	4ST	(12 V)		1971-73	SRB341
CE8	Solenoid	4ST	(24 V)		1971-73	SRB351
Commando (100) G1111, G1175, G1185 11.2 Ton	Solenoid	4ST	(12 V)	5800	1974-75	SRB341
Commando (100) G1111, G1175, G1185 11.2 Ton	Solenoid	4ST	(24 V)	5800	1974-75	SRB351
Commando (100) G1190 11.2 Ton	Solenoid	4ST	(12 V)	5680	1974-75	SRB341
Commando (100) G1190 11.2 Ton	Solenoid	4ST	(24 V)	5680	1974-75	SRB351
Commando (100) G1195 11.2 Ton	Solenoid	4ST	(Petrol) (12 V)		1975	SRB341
Commando (100) G1195 11.2 Ton	Solenoid	4ST	(Truck) (24 V)		1975	SRB351
Commando (100) G1385 13 Ton	Solenoid	4ST	(12 V)	5800	1974-75	SRB341
Commando (100) G1385 13 Ton	Solenoid	4ST	(24 V)	5800	1974-75	SRB351
Commando (100) G1390 13 Ton	Solenoid	4ST	(12 V)	5680	1975	SRB341
Commando (100) G15 90 14.5 Ton Truck	Solenoid	4ST	(12 V)	5680	1974-75	SRB341
Commando (100) G15 90 14.5 Ton Truck	Solenoid	4ST	(24 V)	5680	1974-75	SRB351
Commando (100) G1511 14.5 Ton	Solenoid	4ST	(12 V)	5800	1974-75	SRB341
Commando (100) G1511 14.5 Ton	Solenoid	4ST	(24 V)	5800	1974-75	SRB351



MODEL	TYPE	FUNCTION	ENGINE INFO	CC	YEAR	PART NO.
<b>RVI (RTI) CONTINUED</b>						
Commando (100) G1585 14.5 Ton	Solenoid	4ST	(12 V)	5800	1974-75	SRB341
Commando (100) G1585 14.5 Ton	Solenoid	4ST	(24 V)	5800	1974-75	SRB351
Commando (100) G1590 14.5 Ton	Solenoid	4ST	(12 V)	5680	1974-75	SRB341
Commando (100) G1590 14.5 Ton	Solenoid	4ST	(24 V)	5680	1974-75	SRB351
Commando (100) G1611 16.0 Ton	Solenoid	4ST	(12 V)	5800	1974-75	SRB341
Commando (100) G1611 16.0 Ton	Solenoid	4ST	(24 V)	5800	1974-75	SRB351
Commando (100) G1685 16.0 Ton	Solenoid	4ST	(12 V)	5800	1974-75	SRB341
Commando (100) G1685 16.0 Ton	Solenoid	4ST	(24 V)	5800	1974-75	SRB351
Commando (100) G1690 16.0 Ton	Solenoid	4ST	(12 V)	5680	1974-75	SRB341
Commando (100) G1690 16.0 Ton	Solenoid	4ST	(24 V)	5680	1974-75	SRB351
Commando (100) G1811P 18.0 Ton Tractor Unit	Solenoid	4ST	(12 V)	5800	1974-75	SRB341
Commando (100) G1811P 18.0 Ton Tractor Unit	Solenoid	4ST	(24 V)	5800	1974-75	SRB351
Commando (100) G7560 7.38 Ton	Solenoid	4ST	(12 V)	3860	1974-75	SRB341
Commando (100) G7560 7.38 Ton	Solenoid	4ST	(24 V)	3860	1974-75	SRB351
Commando (100) G7575 7.38 Ton	Solenoid	4ST	(12 V)	5800	1974-75	SRB341
Commando (100) G7575 7.38 Ton	Solenoid	4ST	(24 V)	5800	1974-75	SRB351
Commando (100) G7595 7.38 Ton	Solenoid	4ST	(12 V)	5211	1974-75	SRB341
Commando (100) G7595 7.38 Ton	Solenoid	4ST	(24 V)	5211	1974-75	SRB351
Commando (100) G8660 8.5 Ton	Solenoid	4ST	(12 V)	3860	1974-75	SRB341
Commando (100) G8660 8.5 Ton	Solenoid	4ST	(24 V)	3860	1974-75	SRB351
Commando (100) G8675, G8685 8.5 Ton	Solenoid	4ST	(12 V)	5800	1974-75	SRB341
Commando (100) G8675, G8685 8.5 Ton	Solenoid	4ST	(24 V)	5800	1974-75	SRB351
Commando (100) G8695 8.5 Ton	Solenoid	4ST	(Petrol) (12 V)	5211	1974-75	SRB341
Commando (100) G8695 8.5 Ton	Solenoid	4ST	(Petrol) (24 V)	5211	1974-75	SRB351
KC Walk-Thru 1 1/2, 2, 3 Ton, Diesel	Solenoid	4ST			1969-76	SRB325
PB 1500, 2000, 2500 (Spacevan) Diesel	Solenoid	2ST		1724	1969-70	SRB319
PB 1500, 2000, 2500 (Spacevan) Diesel	Solenoid	4ST		1724	1971-76	SRB341
PB 1500, 2000, 2500 (Spacevan) Diesel	Solenoid	4ST		1724	1976-81	SRB325
VC4, 5, 7	Solenoid	4ST			1969-70	SRB325
VC4, 5, 7	Solenoid	2ST			1970-71	SRB319
VC4, 5, 7	Solenoid	4ST			1971-73	SRB341
VC8	Solenoid	4ST		5800	1969-70	SRB325
VC8	Solenoid	2ST		5800	1970-71	SRB319
VC8	Solenoid	4ST		5800	1971-73	SRB341
<b>SEAT</b>						
Ibiza (II) 1.5i	Fuelling Relay		S/Porsche	1461	1989-93	FDB505
Ibiza 1.5i	Fuelling Relay		S/Porsche	1461	1987-90	FDB505
Malaga 1.5i	Fuelling Relay			1461	1987-91	FDB505
<b>SEDDON ATKINSON</b>						
200 (R16N358) Series	Solenoid	4ST	(24 V)	5870	1976-82	SRB351
200 (R16N358) Series	Solenoid	4ST	(12 V)	5870	1978-82	SRB341
<b>TALBOT (MATRA, SIMCA)</b>						
Alpine 1.3	Solenoid	4ST		1294	1975-85	SRB325
Alpine 1.5	Solenoid	4ST		1442	1975-82	SRB325
Alpine Coupe	Solenoid	4ST		1725	1971-75	SRB325
Avenger 1250	Solenoid	4ST	Estate	1248	1970-73	SRB325
Avenger 1300	Solenoid	4ST	Estate	1295	1973-81	SRB325
Avenger 1500, GT, Tiger, Estate	Solenoid	4ST		1498	1972-73	SRB325
Avenger All Models	Solenoid	4ST		1598	1973-81	SRB325
Hunter All Models	Solenoid	4ST		1725	1966-79	SRB325
Imp, California, Husky, Sports, Van	Solenoid	4ST		875	1965-76	SRB325
Rapier, H 120	Solenoid	4ST		1725	1967-76	SRB325
<b>TVR</b>						
3000M	Solenoid	4ST	Turbo	2994	1972-80	SRB325
3000S, Turbo	Solenoid	4ST		2994	1979-80	SRB325
<b>VAUXHALL</b>						
Astra 1800 GTE	Fuelling Relay		4 Cyl OHC	1796	1983-84	FDB501
Astra 2 1.8i	Fuelling Relay		OHC	1796	1986-91	FDB504
Astra 2 1.8i GTE	Fuelling Relay		OHC	1796	1984-86	FDB501
Astra 2 2.0i GTE	Fuelling Relay		OHC	1998	1987-91	FDB504
Astra 2 2.0i GTE 16v (DOHC)	Fuelling Relay		16v	1998	1988-91	FDB504
Astra 2 Convertible 2.0i	Fuelling Relay		OHC	1998	1991-93	FDB504
Astra 2 Convertible 2.0i GTE	Fuelling Relay		OHC	1998	1987-91	FDB504
Astra 3 2.0 GSi 16v	Fuelling Relay			1998	1991-94	FDB504





MODEL	TYPE	FUNCTION	ENGINE INFO	CC	YEAR	PART NO.
<b>VAUXHALL CONTINUED</b>						
Astra 3 2.0i	Fuelling Relay		DOHC	1998	1991-93	FDB504
Astra 3 2.0i 16v	Fuelling Relay			1998	1994-98	FDB504
Astra 3 Convertible 2.0i	Fuelling Relay		DOHC	1998	1993-94	FDB504
Astra Belmont 1.8i	Fuelling Relay		OHC	1796	1989-91	FDB504
Belmont 1.3, 1.6, 1.6D, 1.8i	Fuelling Relay		(1.8i) OHC	1796	1986-89	FDB504
Calibra 2.0i, 2.0i 16v, 4x4, Turbo	Fuelling Relay		4 Cyl OHC	1998	1990-97	FDB504
Carlton 3 1.8, 1.8i, 2.0i	Fuelling Relay		(Not 1.8)		1986-92	FDB504
Carlton II 2.0i	Fuelling Relay			1998	1990-95	FDB504
Carlton II 2.6i	Fuelling Relay			2594	1990-94	FDB504
Cavalier III 2.0 SRi	Fuelling Relay			1998	1988-92	FDB504
Cavalier III 2.0 SRi	Fuelling Relay		OHC	1998	1990-94	FDB504
Cavalier III 2.0i	Fuelling Relay			1998	1988-95	FDB504
Cavalier III 2.0i 16v (ECOTEC-4)	Fuelling Relay			1998	1994-95	FDB504
Cavalier III 2.0i 4x4	Fuelling Relay		OHC	1998	1988-92	FDB504
Cavalier III 2.0i Turbo 4x4	Fuelling Relay			1998	1992-94	FDB504
Chevette 1300,	Solenoid	4ST		1256	1975-79	SRB335
Cresta (PC),	Solenoid	4ST		3294	1969-72	SRB335
Frontera 2.0i, 2.4i	Fuelling Relay				1991-97	FDB504
Magnum 1800,	Solenoid	4ST		1759	1973-77	SRB335
Magnum 2300, Coupe,	Solenoid	4ST		2279	1973-77	SRB335
Nova (Facelift) 1.6 GSi	Fuelling Relay			1598	1990-93	FDB504
Senator 2 2.5i	Fuelling Relay			2490	1987-90	FDB501
Senator 2 3.0i	Fuelling Relay			2969	1987-92	FDB501
Senator 2 3.0i 24v	Fuelling Relay			2969	1989-94	FDB504
Senator 2.5i, 3.0i	Fuelling Relay				1984-87	FDB501
Ventora FE 3300	Solenoid	4ST		3294	1972-76	SRB335
Victor FD 3300	Solenoid	4ST		3294	1968-72	SRB335
Victor FD 1600	Solenoid	4ST		1599	1969-72	SRB335
Victor FE 2300,	Solenoid	4ST		2279	1972-76	SRB335
Viscount 3300	Solenoid	4ST		3294	1969-72	SRB335
Viva HA	Solenoid	4ST		1057	1963-66	SRB335
Viva HB 1100, 90/SL	Solenoid	4ST		1159	1966-70	SRB335
Viva HB 1100, 90/SL, Brabham	Solenoid	4ST		1159	1966-70	SRB335
Viva HB 1600	Solenoid	4ST		1599	1968-70	SRB335
Viva HB 2000 GT	Solenoid	4ST		1975	1968-70	SRB335
Viva HC 1100, SL90	Solenoid	4ST		1159	1970-71	SRB335
Viva HC 1256,	Solenoid	4ST		1256	1971-79	SRB335
Viva HC 1300	Solenoid	4ST		1256	1971-79	SRB335
Viva HC 1600	Solenoid	4ST		1599	1970-72	SRB335
Viva HC 1800,	Solenoid	4ST		1759	1973-79	SRB335
Viva HC 2300,	Solenoid	4ST		2279	1972-73	SRB335
Viva HC Coupe 1256 E	Solenoid	4ST		1256	1971-75	SRB335
VX 1800	Solenoid	4ST		1759	1976-78	SRB335
VX 2000 4/90	Solenoid	4ST		1975	1969-71	SRB335
VX 2300, 4/90	Solenoid	4ST		2279	1972-78	SRB335
<b>VOLVO LEYLAND (AEC)</b>						
National II	Solenoid	4ST			1973-75	SRB346
National II	Solenoid	4ST			1976-78	SRB351
Titan	Solenoid	4ST			1979	SRB351
<b>VW</b>						
All Models	Fuelling Relay		1.9TDi		10/88-11/96	FDB516
Corrado 1.8 G60	Fuelling Relay		4 Cyl DOHC	1781	10/88-94	FDB507
Golf (II) 1.8	Fuelling Relay		4 Cyl OHC GX	1781	1984-07/85	FDB509
Golf (II) 1.8 GT/Xi	Fuelling Relay		4 Cyl OHC	1781	08/85-04/87	FDB511
Golf (II) 1.8 GT/Xi	Fuelling Relay		4 Cyl OHC	1781	1984-07/85	FDB509
Golf (II) 1.8 GT/Xi	Fuelling Relay		{CH} 4 Cyl OHC	1781	1984-07/85	FDB509
Golf (II) 1.8 GTi G60	Fuelling Relay		4 Cyl DOHC 16v	1781	04/90-07/91	FDB507
Golf (II) 1.8 Rallye	Fuelling Relay		4 Cyl DOHC 16v	1763	08/90-10/91	FDB507
Golf (II) 1.8 Syncro	Fuelling Relay		4 Cyl OHC	1781	02/86-07/88	FDB509
Jetta (II) 1.8	Fuelling Relay		4 Cyl OHC	1781	1984-07/85	FDB509
Jetta (II) 1.8	Fuelling Relay		{CH} 4 Cyl OHC	1781	1984-07/85	FDB509
Jetta (II) 1.8 GT/X	Fuelling Relay		4 Cyl OHC	1781	08/85-04/87	FDB511
Jetta (II) 1.8 GT/X	Fuelling Relay		{CH} 4 Cyl OHC	1781	08/85-07/86	FDB511
Jetta (II) 1.8 Syncro	Fuelling Relay		4 Cyl OHC	1781	02/86-07/88	FDB509
Jetta 1800i	Fuelling Relay		4 Cyl OHC	1781	08/82-07/83	FDB510
Passat (II) 2.0i Syncro	Fuelling Relay		5 Cyl OHC	1994	08/85-02/88	FDB510
Passat (II) 2.2i	Fuelling Relay		5 Cyl OHC	2226	08/85-03/88	FDB510





## TERMINATIONS GUIDE

LUCAS TERMINALS		ALTERNATIVE MARKINGS
Markings	Connections	
B, X, +, 49	Ignition Controlled Supply	1, 15, 2, 4, +49, +15, 14A, 15X, 153, H, 15A
P, C	Vehicle Pilot Light	R, KP, 1P, 8, REP, T, KBC, 5, KBL
L, 49a	Direction Indicator Switch	C, 2, 5, S54, 1L, 49S, 6, COM, 54L, L54, 0, CL, S
C2	Trailer Pilot Light	P2, Lead
-, 31	Earth (Ground)	1, 5, 31, E, Masse, $\Sigma$

### To produce synchronised flashing lamps

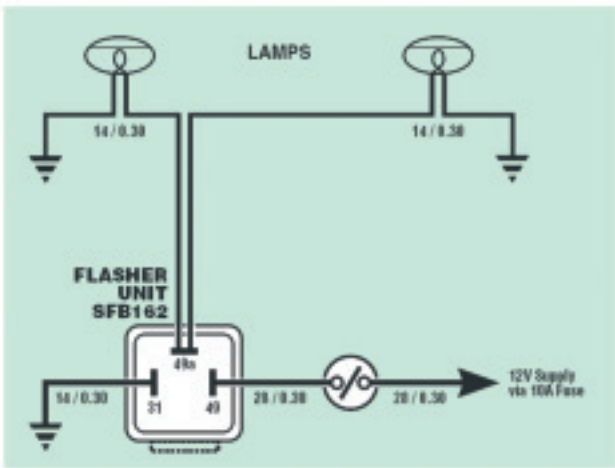

### Lucas Relays Terminations Guide

Terminal designation	Recommended Polarity	Terminal definition		
W2	1	85	+	Start of winding
W1	2	85	-	End of winding to negative
C1	5	87	-	NO contacts
C2	3	30	-	Switch input
C3	4	87a	-	NC contacts
		87b	-	NO double contacts
		87c	-	NO double contacts
		80a	-	Start of winding or 1st winding
		80b	-	Winding Tap or 2nd winding
		88	-	Relay input (make-contact side)
		88a	-	1st Output (make-contact side)
		88b, c, d, e, f	-	Other outputs (make-contact side)
		88c	-	1st Input (make-contact)
		88d, e	-	2nd & 3rd Input (make-contact)
		15	-	Switched + from Battery (output of ignition or start switch)
		1	-	Ignition coil – Low voltage side
		30	+	Starter control circuit
		31	-	Returns to battery –ve (ground)
		70	-	12 V square wave input from ECU
		51	+	Positive output from Generator / Alternator
		85b	-	End of second winding



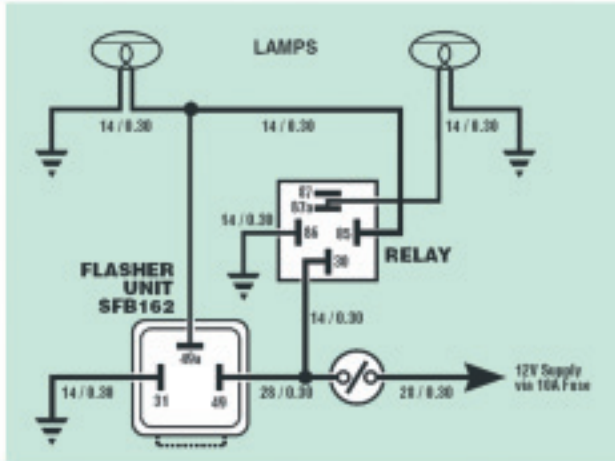











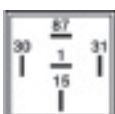

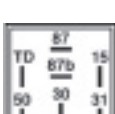

### To produce alternating flashing lamps

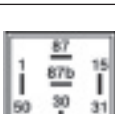

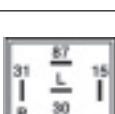
#### Key for Contacts

- Normally Open Contacts
- Normally Closed Contacts
- Double Contacts
- Changeover Relay

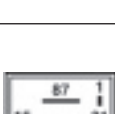

PART NO.	DESCRIPTION	PRODUCT	FUNCTION	TECHNICAL ILLUSTRATION	TERMINATION	VOLTS	AMPS/ WATTS	SPECIFICATION	APPLICATION
<b>FUELLING RELAYS</b>									
FDB501	Fuelling Relay					12V	16A	PRIME TIME: N/A FALL TIME: 0,5 sec max.	GM, VAUXHALL, OPEL
FDB502	Fuelling Relay					12V	16A	PRIME TIME: 0,8 - 0,9 sec FALL TIME: 0,5 - 0,9 sec	FORD
FDB503	Fuelling Relay					12V	16A	PRIME TIME: N/A FALL TIME: 0,7 - 1,1 sec	FORD
FDB504	Fuelling Relay					12V	7,5A	PRIME TIME: N/A	GM, VAUXHALL, OPEL
FDB505	Fuelling Relay					12V	16A	PRIME TIME: N/A FALL TIME: 0,1 - 0,5 sec	CITROEN, FERRARI, FIAT, LANCIA, PEUGEOT, SEAT
FDB506	Fuelling Relay					12V	16A	PRIME TIME: N/A FALL TIME: 0,2 - 0,6 sec	CITROEN
FDB507	Fuelling Relay					12V	16A	DELAY TIME: 120 sec min after 'turn off' of terminal 15 with L&P connected	VAG, VW
FDB508	Fuelling Relay + max rpm control					12V	16A	PRIME TIME: N/A FALL TIME: 0,8 - 1,2 sec, LIMIT: 6500 rpm (4cyl)	VAG, VW
FDB509	Fuelling Relay + max rpm control					12V	16A	PRIME TIME: N/A FALL TIME: 0,8 - 1,2 sec, LIMIT: 6500 rpm (5cyl)	VAG, VW, AUDI
FDB510	Fuelling Relay + max rpm control					12V	16A	PRIME TIM : N/A FALL TIME: 0,8 - 1,2 sec, LIMIT: 7100 rpm (5cyl)	VAG, VW, AUDI























PART NO.	DESCRIPTION	PRODUCT	FUNCTION	TECHNICAL ILLUSTRATION	TERMINATION	VOLTS	AMPS/WATTS	SPECIFICATION	APPLICATION
<b>FUELLING RELAYS CONTINUED</b>									
FDB511	Fuelling Relay + max rpm control					12V	16A	PRIME TIME: N/A FALL TIME: 0,8 - 1,2 sec, LIMIT: 6700 rpm (4cyl)	VAG, VW, AUDI
FDB516	Fuelling Relay					12V	40A		VAG
<b>FLASHER UNITS</b>									
SFB100	Flasher Unit					12V	42W	(2 x 21 W)	
SFB105	Flasher Unit					12V	42W	(2 x 21 W)	FIAT, JAGUAR, LOTUS, SKODA, TRIUMPH
SFB106	Flasher Unit					24V	51W	(2 x 24 W) + (2.8 W)	BEDFORD, DENNIS EAGLE, DODGE COMM, RENAULT TRUCKS
SFB108	Flasher Unit					24V	51W	(2 x 24 W) + (2.8 W)	IVECO FORD, LANVER BROS, LEYLAND DAF, TEREX
SFB114	Flasher Unit					12V	42W	(2 x 21 W) + (5 W)	ASTON MARTIN, BEDFORD, BENTLY, FORD, JAGYAR, LAND ROVER, LDV, LOTUS, MORGAN, RELIANT, ROLLS ROYCE, ROVER, TALBOT, TVR
SFB130	Flasher Unit					12V	89W	(4 x 21 W) + (5 W)	ASTON MARTIN, BEDFORD, BENTLY, CARBODIES, FORD, JAGYAR, LAND ROVER, LDV, LOTUS, MORGAN, RELIANT, ROLLS ROYCE, ROVER, TALBOT, TVR
SFB153	Flasher Unit					12V	98W	(2 x 21 W) + (5 W), (4 x 21 W) + (5 W) WSL THEN SFB190	BEDFORD, FORD
SFB156	Flasher Unit					12V	98W	(2 x 21 W) + (5 W), (4 x 21 W) + (5 W) WSL THEN SFB190	ROVER

RELAY SWITCHES – PRODUCT SPECIFICATION

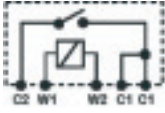

PART NO.	DESCRIPTION	PRODUCT	FUNCTION	TECHNICAL ILLUSTRATION	TERMINATION	VOLTS	AMPS/ WATTS	SPECIFICATION	APPLICATION
<b>FLASHER UNITS CONTINUED</b>									
SFB161	Flasher Unit					12V	98W	(2 x 21 W) + (5 W), (4 x 21 W) + (5 W)	DAIHATSU, HONDA, HYUNDAI, ISUZU, MAZDA, MITSUBISHI, NISSAN, SAO, SUBARU, SUZUKI, TOYOTA
SFB162	Flasher Unit					12V	98W	(2 x 21 W) + (5 W), (4 x 21 W) + (5 W) WSL THEN SFB190	ASTON MARTIN, AUDI, BEDFORD, BMW, FIAT, FORD, HYUNDAI, IVECO FORD, LADA, LANCIA, LDV, LOTUS, MERCEDES BENZ, OPEL, PORSCHE, RELIANT, ROVER, SAAB, TOYOTA, TVR, VAUXHALL, VOLVO, VOLOV TRUCK, VW, YUGO
SFB163	Flasher Unit					12V	140W	(2 x 21 W) + (5 W), (4 x 21 W) + (5 W)	ALFA ROMEO, CITROEN, FIAT, FSO, LADA, PEUGEOT, RENAULT, SEAT, SKODA, TALBOT
SFB164	Flasher Unit					12V	140W	(2 x 21 W) + (5 W), (6 x 21 W) + (5 W)	ALFA ROMEO, ASTON MARTIN, AUDI, BEDFORD, BMW, CITROEN, FIAT, FORD, HYUNDAI, IVECO FORD, LANCIA, LAND ROVER, LDV, LOTUS, MERCEDES BENZ, OPEL, PORSCHE, RELIANT, ROVER, SAAB, TOYOTA, TVR, VAUXHALL, VOLVO, VW, YUGO
SFB165	Flasher Unit					12V	140W	(3 x 21 W) + (5 W), (6 x 21 W) + (5 W)	ALFA ROMEO, CITROEN, FIAT, FSO, LADA, LAND ROVER, PEUGEOT, RENAULT, SEAT, SKODA, TALBOT
SFB166	Flasher Unit					24V	98W	(2 x 21 W) + (5 W), (4 x 21 W) + (5 W)	AVELING BARFORD, BEDFORD, JCB, FORD
SFB167	Flasher Unit					24V	140W	(3 x 21 W) + (5 W), (6 x 21 W) + (5 W)	BEDFORD, DENNIS, ERF, FORD, LEYLAND
SFB170	Flasher Unit					12V	98W	(2 x 21 W) + (5 W) + (1.2 W), (4 x 21 W) + (2 x 5 W) + (2 x 2.1 W) WSL THEN SFB190	HONDA, ROVER
SFB171	Flasher Unit					12V	140W	(3 x 21 W) + (5 W) + (1.2 W), (6 x 21 W) + (2 x 5 W) + (2 x 2.1 W)	HONDA, ROVER
SFB182	Flasher Unit					12V	98W	(2 x 21 W) + (5 W), (4 x 21 W) + (5 W) WSL THEN SFB190	ALFA ROMEO, CITROEN, FORD, JAGUAR, PEUGEOT, PROTON, TVR, VOLVO

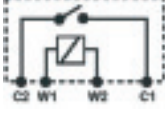

PART NO.	DESCRIPTION	PRODUCT	FUNCTION	TECHNICAL ILLUSTRATION	TERMINATION	VOLTS	AMPS/WATTS	SPECIFICATION	APPLICATION
<b>FLASHER UNITS CONTINUED</b>									
SFB190	Flasher Unit					12V	98W	(2 x 21 W) + (5 W), (4 x 21 W) + (5 W)	ALFA ROMEO, ASTON MARTIN, AUDI, BEDFORD, BMW, CITROEN, FIAT, FORD, HONDA, HYUNDAI, IVECO FORD, JAGUAR, LADA, LANCIA, LDV, LOTUS, MERCEDES BENZ, OPEL, PEUGEOT, PORSCHE, PROTON, RELIANT, ROVER, SAAB, TOYOTA, TVR, VAUXHALL, VOLVO, VW, YUGO
SFB191	Flasher Unit					12V		2 + (1 x 21 W) (6 x 21 W)	
<b>COMMERCIAL</b>									
SFB200	Commercial					24V		3+1(8) x 21W Hella 4WM003215154	
SFB210	Commercial					24V		2+1(6) x 21W + 0-5W Hella 4WM003944041	DAF, IVECO, MERCEDES, MAN, RENAULT, VOLVO
SFB211	Commercial					24V		2+1(6) x 21W Hella 4WM003474017	LEYLAND, RENAULT, SEDDIN, ATKINSON
SFB212	Commercial					24V		2+1(6) x 21W Hella 4WM003474027	
<b>CLASSIC RELAYS</b>									
33292	Classic Relay					12v			LAND ROVER
SRB111	Classic Relay					12V	20A	NEOPRENE	
SRB113	Classic Relay					12V	20A	NEOPRENE	

RELAY SWITCHES – PRODUCT SPECIFICATION















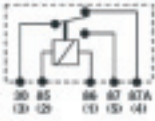



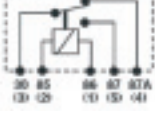



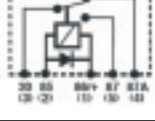



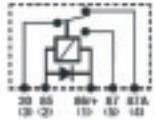



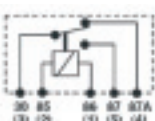



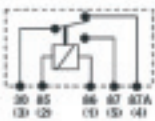



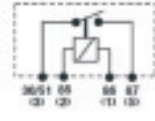

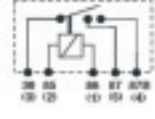

PART NO.	DESCRIPTION	PRODUCT	FUNCTION	TECHNICAL ILLUSTRATION	TERMINATION	VOLTS	AMPS/WATTS	SPECIFICATION	APPLICATION
<b>CLASSIC RELAYS CONTINUED</b>									
SRB143	Classic Relay					12V	20A	STANDARD	
SRB146	Classic Relay					12V	20A	STANDARD	
SRB220	Classic Relay					24V	10A	NEOPRENE	
SRB301	Classic Relay								
SRB303	Classic Relay								
<b>2ST / 4ST</b>									
SRB319	2ST					12V	2.3 Ohms	INSULATED EARTH RETURN Surge Current 600amps, Carrying & Breaking Current 200amps	
SRB321	2ST					24V	10.0 Ohms	INSULATED EARTH RETURN Surge Current 250amps, Carrying & Breaking Current 100amps	
SRB325	4ST					12V	2.3 Ohms	EARTH RETURN Surge Current 600amps, Carrying & Breaking Current 200amps	
SRB333	4ST					12V	2.3 Ohms	EARTH RETURN For use with Ballasted Ignition Coil Surge Current 600amps, Carrying & Breaking Current 200amps	

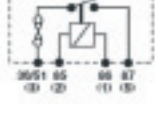

PART NO.	DESCRIPTION	PRODUCT	FUNCTION	TECHNICAL ILLUSTRATION	TERMINATION	VOLTS	AMPS/WATTS	SPECIFICATION	APPLICATION
<b>2ST / 4ST CONTINUED</b>									
SRB335	4ST					12V	2.3 Ohms	EARTH RETURN For use with Ballasted Ignition Coil Surge Current 600amps, Carrying & Breaking Current 200amps	
SRB341	4ST					12V	2.3 Ohms	INSULATED EARTH RETURN Surge Current 600amps, Carrying & Breaking Current 200amps	
SRB346	4ST					24V	10.0 Ohms	EARTH RETURN Surge Current 250amps, Carrying & Breaking Current 100amps	
SRB351	4ST					24V	10.0 Ohms	INSULATED EARTH RETURN Surge Current 250amps, Carrying & Breaking Current 100amps	
<b>26RA / 28RA</b>									
SRB400	26RA					12V	20A	STANDARD	
SRB402	26RA					12V	20A	STANDARD	
SRB411	26RA					12V	20A	STANDARD	
SRB420	26RA					24V	10A	STANDARD	
SRB500	28RA					12V	20/30A		

RELAY SWITCHES – PRODUCT SPECIFICATION

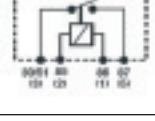

PART NO.	DESCRIPTION	PRODUCT	FUNCTION	TECHNICAL ILLUSTRATION	TERMINATION	VOLTS	AMPS/ WATTS	SPECIFICATION	APPLICATION
<b>26RA / 28RA CONTINUED</b>									
SRB501	28RA					12V	20/30A	OPTIONAL BRACKET	
SRB502	28RA					12V	20/30A	Consists of: 1 x SRB500 relay 1 x Relay mounting block 5 x 1/4" Lucas connectors	
SRB506	28RA					12V	20/30A	DIODE OPTIONAL BRACKET	
SRB507	28RA					24V	10/20A	DIODE OPTIONAL BRACKET	
SRB510	28RA					24V	10/20A		
SRB511	28RA					24V	10/20A	OPTIONAL BRACKET	
SRB520	28RA					12V	30A	OPTIONAL BRACKET	
SRB521	28RA					12V	2x20A	OPTIONAL BRACKET	
SRB522	28RA					12V	15A	FUSED OPTIONAL BRACKET	
SRB523	28RA					12V	30A	OPTIONAL BRACKET	



PART NO.	DESCRIPTION	PRODUCT	FUNCTION	TECHNICAL ILLUSTRATION	TERMINATION	VOLTS	AMPS/WATTS	SPECIFICATION	APPLICATION
<b>26RA / 28RA CONTINUED</b>									
SRB525	28RA					12V	20/30A	RESISTOR OPTIONAL BRACKET	
SRB526	28RA					12V	2x30A	OPTIONAL BRACKET	
SRB527	28RA					12V	30/40A	OPTIONAL BRACKET	
SRB528	28RA					12V	2x15A	OPTIONAL BRACKET	
SRB529	28RA					12V	2x20A	RESISTOR	
SRB530	28RA					24V	20A	OPTIONAL BRACKET	
SRB531	28RA					24V	2x10A	OPTIONAL BRACKET	
SRB532	28RA					24V	15A	FUSED OPTIONAL BRACKET	
SRB533	28RA					24V	20A	OPTIONAL BRACKET	
SRB535	28RA					24V	10/20A	RESISTOR OPTIONAL BRACKET	

RELAY SWITCHES – PRODUCT SPECIFICATION



PART NO.	DESCRIPTION	PRODUCT	FUNCTION	TECHNICAL ILLUSTRATION	TERMINATION	VOLTS	AMPS/WATTS	SPECIFICATION	APPLICATION
<b>26RA / 28RA CONTINUED</b>									
SRB537	28RA					12V	40A	RESISTOR OPTIONAL BRACKET	
SRB538	28RA					24V	2x10A	OPTIONAL BRACKET	
SRB539	28RA					12V	70A	OPTIONAL BRACKET	
SRB540	28RA					12V	70A	RESISTOR	
SRB541	28RA					24V	40A	OPTIONAL BRACKET	
<b>33RA – SPLIT CHARGE RELAYS</b>									
SRB600	33RA					12V	60A	STANDARD CONTINUOUS	
SRB601	33RA					24V	40A	STANDARD CONTINUOUS	
SRB630	33RA					12V	60A	STANDARD CONTINUOUS	
<div style="border: 1px solid black; padding: 5px;"> <p><b>SRB630 is suitable for charging two independent batteries from a single source. Extra terminal for multipole operation.</b></p> <ul style="list-style-type: none"> <li>1 Select a split free area to mount the SRB630 relay preferably in the engine compartment.</li> <li>2 Identify source of each connection of existing battery and link or earth the similar terminal of the additional battery.</li> <li>3 Using the cable sizes specified connect the SRB630 relay as shown in the diagram.</li> </ul> <p>Keep cable runs as short as possible, particularly main charging leads. Ensure insulation above any fibro-well connectors. Load-over 20A (connects to the additional battery). Should not be collected on when the engine is running.</p> <ol style="list-style-type: none"> <li>1 Alternator - Running Light Terminal</li> <li>2 Main battery</li> <li>3 Additional battery</li> <li>4 Multipole terminal</li> </ol> </div>									

RELAY SWITCHES – PRODUCT SPECIFICATION



PART NO.	DESCRIPTION	PRODUCT	FUNCTION	TECHNICAL ILLUSTRATION	TERMINATION	VOLTS	AMPS/WATTS	SPECIFICATION	APPLICATION
<b>33RA – SPLIT CHARGE RELAYS CONTINUED</b>									
SRB631	33RA					12V	60A	STANDARD INTERMITTENT	
SRB632	33RA					24V	40A	NEOPRENE INTERMITTENT	
<b>MISCELLANEOUS</b>									
SCB312	Dim Dip Relay					12V		13DA	
SCB314	Dim Dip Relay					12V		13DA	ROVER
SCB316	Wiper Relay					12V		13DA	LDV - 02/88 - 11/95
SCB318	Wiper Relay					12V		13DA	
SCB400	Resister					12V		RESISTANCE: 1.3 - 1.4 Ohms	
SRB542	Relay					12V	40A		
SRB901	In Line Diode								

RELAY SWITCHES – PRODUCT SPECIFICATION





# 3

## Accessories

Application List

Page 3.106

Product Specification

Page 3.107









# Accessories



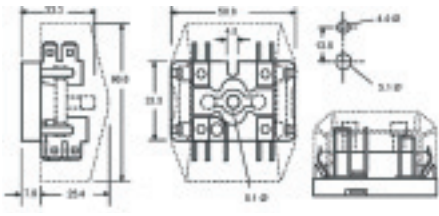

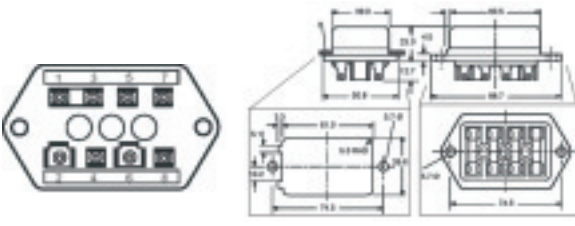
MODEL	TYPE	FUNCTION	ENGINE INFO	CC	YEAR	PART NO.
<b>JAGUAR</b>						
Daimler Limousine	Body Switch	Foot dip	6 Cyl	4235	1969-73	<b>34790</b>
<b>JONES CRANES</b>						
Iron Fairy Garnet, Opal Mobile Crane	Body Switch	Foot dip			1971-78	<b>34790</b>
Iron Fairy Sapphire 6, 7, 8 Ton Mobile Crane	Body Switch	Foot dip			1971-78	<b>34790</b>
Iron Fairy Six 6, 8, 10 Ton Mobile Crane	Body Switch	Foot dip			1971-80	<b>34790</b>
Iron Fairy Tourmaline	Body Switch	Foot dip			1973-78	<b>34790</b>
<b>LEYLAND DAF</b>						
J4 180 1500 Diesel, 1600	Body Switch	Foot dip			1969-74	<b>34790</b>
J4 190 1500 Diesel, 1600	Body Switch	Foot dip	4 Cyl OHV		1969-74	<b>34790</b>
J4 200 1500 Diesel	Body Switch	Foot dip		1489	1969-74	<b>34790</b>
J4 200 1600	Body Switch	Foot dip		1622	1969-74	<b>34790</b>
<b>ROLLS ROYCE</b>						
Camargue	Body Switch	Foot dip	V8 OHV	6750	1979-86	<b>34790</b>
Corniche	Body Switch	Foot dip	V8 OHV	6750	1979-84	<b>34790</b>
Corniche T	Body Switch	Foot dip	V8 OHV	6750	1979-82	<b>34790</b>
Mulsanne	Body Switch	Foot dip	V8 OHV	6750	1981-84	<b>34790</b>
Mulsanne Turbo	Body Switch	Foot dip	V8 OHV	6750	1982-84	<b>34790</b>
Silver Shadow II	Body Switch	Foot dip	V8 OHV	6750	1979-80	<b>34790</b>
Silver Spirit	Body Switch	Foot dip	V8 OHV	6750	1981-84	<b>34790</b>
Silver Spur	Body Switch	Foot dip	V8 OHV	6750	1981-84	<b>34790</b>
T2 Series	Body Switch	Foot dip	V8 OHV	6750	1979-80	<b>34790</b>
<b>ROVER</b>						
MGB	Body Switch	Foot dip	B Series	1798	1969	<b>34790</b>
MGB GT	Body Switch	Foot dip		1798	1969	<b>34790</b>
MGC, GT	Body Switch	Foot dip	6 Cyl OHV	2912	1969	<b>34790</b>
Triumph TR6 PI (125 bhp)	Body Switch	Foot dip		2498	1972-75	<b>34790</b>
Triumph TR6 PI (132/150 bhp)	Body Switch	Foot dip		2498	1969-72	<b>34790</b>
<b>VOLVO LEYLAND (AEC)</b>						
Atlantean	Body Switch	Foot dip			1969-83	<b>34790</b>
Fleet Line 30, 33	Body Switch	Foot dip		10450	1972-81	<b>34790</b>
Fleet Line 36	Body Switch	Foot dip		10450	1972-81	<b>34790</b>
Reliance 6MU2L, R, 6MU3L, R, 6MU4R	Body Switch	Foot dip			1969-78	<b>34790</b>
Reliance 6U2R (AV691/6)	Body Switch	Foot dip			1969-76	<b>34790</b>
Reliance 6U2R (AV760/6)	Body Switch	Foot dip			1969-78	<b>34790</b>
Reliance 6U3L/ZRE	Body Switch	Foot dip			1969-76	<b>34790</b>
Reliance 6U3ZL/ZRE	Body Switch	Foot dip			1969-78	<b>34790</b>
Reliance 8U3ZL/ZR (AV691/6)	Body Switch	Foot dip			1969-76	<b>34790</b>
Reliance 8U3ZL/ZR (AV760/6)	Body Switch	Foot dip			1969-78	<b>34790</b>
Victory (Gardner 6LX) (Leyland 680)	Body Switch	Foot dip			1971-73	<b>34790</b>
Victory J (Gardner 6LX)	Body Switch	Foot dip		10450	1971-73	<b>34790</b>
Victory, J (Gardner 6LXB)	Body Switch	Foot dip		10450	1974-77	<b>34790</b>

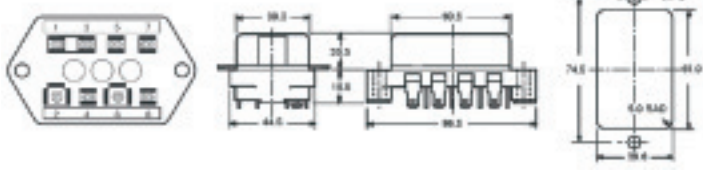

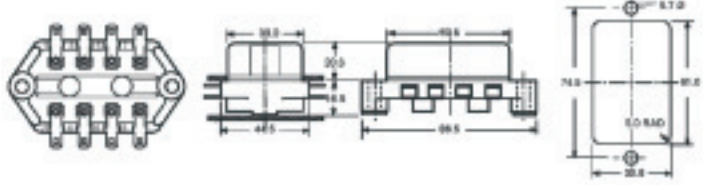
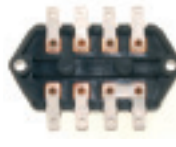
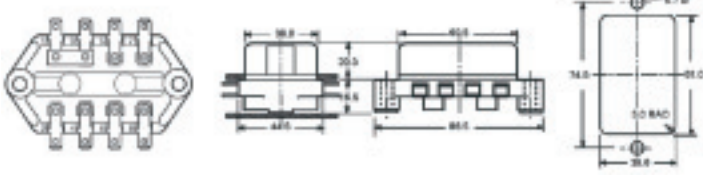

PART NO.	PRODUCT	TERMINATION	COMMENT
<b>DIP SWITCH</b>			
31284	Foot operated dip switch 		
34790	Foot operated dip switch 		
<b>FUSE BOXES</b>			
54038068	4FJ Fuse Box 		Surface mounted fuse box with detachable cover. Suitable for car and light commercial vehicles. 12/24V applications, not marine. All terminals are 6.35mm, 17.5 A Lucar blades. Accepts glass cartridge fuses 29.4mm long. Built-in positions for spare fuses. Supplied less fuses.
37409	6FJ Fuse Box 		General purpose fuse box suitable for car, agricultural, industrial and commercial vehicle. 12/24V applications, excluding marine. Designed for mounting through vehicle bulkhead, detachable cover. All terminals are 6.35mm, 17.5A Lucar blades. Accepts glass cartridge fuses 29.4mm long. Built-in positions for 2 spare fuses. Supplied less fuses.
37416	7FJ Fuse Box 		General purpose fuse box suitable for car, agricultural, industrial and commercial vehicle. 12/24V applications, excluding marine. Surface or through bulkhead mounting, detachable cover. All terminals are 6.35mm, 17.5A Lucar blades. Accepts glass cartridge fuses 29.4mm long. Built-in positions for 2 spare fuses. Supplied less fuses.
37420	7FJ Fuse Box 		General purpose fuse box suitable for car, agricultural, industrial and commercial vehicle. 12/24V applications, excluding marine. Surface or through bulkhead mounting, detachable cover. All terminals are 6.35mm, 17.5A Lucar blades. Accepts glass cartridge fuses 29.4mm long. Built-in positions for 2 spare fuses. Supplied less fuses.
37552	7FJ Fuse Box 		General purpose fuse box suitable for car, agricultural, industrial and commercial vehicle. 12/24V applications, excluding marine. Surface or through bulkhead mounting, detachable cover. All terminals are 6.35mm, 17.5A Lucar blades. Accepts glass cartridge fuses 29.4mm long. Built-in positions for 2 spare fuses. Supplied less fuses.



PART NO.	PRODUCT	TERMINATION	COMMENT
<b>FUSE BOXES CONTINUED</b>			
37564	Fuse Box 		
<b>FUSE BOX COVERS</b>			
54380114	Fuse Box Cover 		
54382781	Fuse Box Cover 		
<b>BULBHOLDER</b>			
54363860	Bulbholder 		



# Cross Reference 4



CROSS REFERENCE FROM	TO LUCAS PART NUMBER
<b>COMMERCIAL IGNITION</b>	
XFL102	SFB162
XFL104	SFB161
XFL105	SFB163
XFL106	SFB164
XFL107	SFB165
XRL101	SRB520
XRL102	SRB530
XRL103	SRB523
XRL105	SRB501
XRL105	SRB525
XRL106	SRB511
XRL106	SRB535
<b>DAIHATSU</b>	
8198087101	SFB182
8198087705	SFB161
<b>DURITE</b>	
32654	SPB208
33500	SRB325
33501	SRB335
33503	SRB333
33504	SRB321
33505	SRB319
33508	SRB351
35106	35670
35107	35630
60500	SSB112
60545	SSB201
60550	SSB111
60560	SSB200
60565	SSB202
60570	SSB203
60599	SSB113
72311	FDB503
72313	FDB502
72322	FDB501
72323	FDB504
72331	FDB508
72333	FDB510
72342	FDB506
72624	SRB532
72712	SRB520
72724	SRB530
72732	SRB528
72740	SRB541
72744	SRB538
72762	SRB523
72770	SRB539
72771	SRB540
72774	SRB533
72812	SRB501
72814	SRB506
72815	SRB525
72824	SRB511
72826	SRB507
72827	SRB535
74413	SFB161
74424	SFB166
74436	SFB165
74438	SFB163
74444	SFB210
74445	SFB211

CROSS REFERENCE FROM	TO LUCAS PART NUMBER
74454	SFB200
85605	LBM12500
85615	LBM122000
85655	LBM24500
85660	LBM241000
85665	LBM242000
085601A	LBM12150
085602A	LBM12300
085610A	LBM121000
3350	SRB325
33500	SRB325
33502	SRB335
33503	SRB333
33504	SRB321
33505	SRB319
3351	SRB335
3352	SRB335
3353	SRB333
3354	SRB321
3355	SRB319
34901	SPB358
48500	SPB353
49600	SPB359
53105	SPB350
60300	SPB351
60350	SPB352
60600	SFB105
60612	SFB114
60902	SPB356
60904	SPB355
60905	SPB354
60910	SPB357
60962	SPB363
60964	SPB361
60965	SPB360
60970	SPB362
64550	SPB364
68700	SPB365
72612	SRB522
72624	SRB532
72712	SRB520
72722	SRB521
72724	SRB530
72732	SRB528
72734	SRB531
72740	SRB601
72744	SRB538
72762	SRB523
72770	SRB600
72774	SRB533
72812	SRB501
72812	SRB525
72824	SRB511
72824	SRB535
72862	SRB527
74412	SFB153
74413	SFB161
74422	SFB182
74424	SFB166
74436	SFB165
74438	SFB163
74462	SFB164

CROSS REFERENCE FROM	TO LUCAS PART NUMBER
<b>FEBI</b>	
10551	SQB352
17116	SQB353
19054	SQB355
19723	SQB385
19725	SQB386
<b>FENDT</b>	
X830250007	SRB500
X830250007	SRB525
X830250020	SRB521
X830250021	SRB501
X830250021	SRB525
<b>FERRARI</b>	
62370600	FDB505
<b>FIAT</b>	
4320625	SRB521
4320625	SRB528
4320629	SRB521
4320629	SRB528
60534316	FDB505
7573490	SFB162
7576067	FDB505
7628059	FDB505
82430021	SFB162
<b>FORD</b>	
1007910	SPB314
1021784	SQB365
1027139	SQB353
1027144	SQB353
1027166	SQB352
1027167	SQB352
1027172	SQB355
1041412	SQB366
1052252	SQB385
1072657	SQB367
1097541	SQB364
6058163	SFB200
6993548	SQB386
7061446	SQB353
7107010	SQB353
7107012	SQB352
7195082	SPB316
7248362	SPB315
2002E11450A	SRB351
302E10A376A	SRB111
6107322	FDB503
6145938	FDB502
6161570	FDB502
674E11523	SSB106
69DB-13350-AA	SFB108
69UB-13350-AA	SFB114
69VB-13350-AA	SFB114
73AB11450AA	SRB333
73NB14K032AA	SPB106
74VB11450BA	SRB333
755F11450AA	SRB341
76LB9L448AA	SRB402
77FG-13350-CA	SFB153
78LB9L448AA	SRB402
81AB15040AA	SRB501
81AB15040AA	SRB525

CROSS REFERENCE FROM	TO LUCAS PART NUMBER
81DB14K032AB	SPB106
81VB9P70AA	SRB411
82GG9P704AA	FDB503
83BG-13350-AA	SFB153
85AG9P704AA	FDB502
85GG-13350-AA	SFB182
85GG9P704AA	FDB502
92939524	SSB100
A700X11450AA	SRB325
A710X11450BA	SRB335
D5NN11N501A	30810
E34NG2	SRB111
6082593	SPB310
81DB13A350AA	SPB310
<b>GM</b>	
9181010	SQB225
9287211	SRB523
1238539	FDB504
1238540	FDB504
1238542	FDB501
1238549	FDB504
1238563	FDB501
1238566	FDB501
1238587	SRB522
1238621	SRB523
1238966	FDB504
1241132	SQB224
1241212	SQB225
2684388	SRB335
2696459	31270
6331286	31780
6342826	31743
6344788	SRB111
6390704	SFB106
7212406	SRB335
7212463	SRB325
8819242	SRB325
8819243	SRB325
8824563	SFB114
8824608	SFB130
8824849	SFB106
8862228	SFB164
90008100	SRB522
90124673	FDB501
90158189	FDB501
90158443	FDB501
90191753	SRB500
90213542	FDB501
90225811	FDB504
90230894	FDB504
90240698	FDB504
90243395	SQB224
91005213	SFB162
91011800	30669
91031694	35476
91042458	SRB351
91053846	SRB402
91075124	34775
91079279	SRB420
91093257	SRB402
91095654	SRB501
91095654	SRB525
91096557	SFB153







CROSS REFERENCE FROM	TO LUCAS PART NUMBER
<b>LUCAS CONTINUED</b>	
35423	SQB113
35436	SQB114
35441	SQB704
35455	SQB705
35461	SQB222
35462	SQB223
35483	SQB115
35485	SQB116
36520	SQB940
36602	SQB407
36603	SQB409
36606	SQB140
36610	SQB141
36611	SQB143
36619	SQB106
36620	SQB122
36623	SQB135
36634	SQB108
36644	SQB136
36648	SQB718
36658	SQB421
36659	SQB425
36663	SQB160
36664	SQB161
36668	SQB109
36702	SQB964
36710	SQB803
36722	SQB707
36750	SQB420
36752	SQB423
36788	SQB175
36789	SQB176
36798	SQB417
36860	SQB183
36886	SCB316
36907	SQB500
36908	SQB134
36909	SQB709
36943	SQB426
36944	SQB427
36945	SQB428
36970	SQB710
36971	SQB711
36972	SQB712
36973	SQB713
37826	SRB500
37872	SCB314
37934	SQB714
38832	SQB716
39384	SQB168
39553	SQB118
39664	SQB967
39897	SQB119
47222	SCB400
54006277	SFB300
54006501	SFB300
54033230	SPB104
54033585	SFB300
54033623	SPB107
54033732	SQB968
54033733	SQB126
54033922	35670
54034003	SSB100

CROSS REFERENCE FROM	TO LUCAS PART NUMBER
54034005	SSB102
54034007	SSB101
54038095	SFB114
54038121	SRB400
54038130	SRB411
54038131	SRB420
54038134	SRB500
54038138	SRB402
54362147	SFB300
54362978	SFB130
60033012	SFB300
60604011	SQB803
6211-650	SRB631
6211-651	SRB632
6400-222	SRB501
6400-223	SRB511
6400-305	SRB533
76205	SPB160
76411	SRB325
76415	SRB325
76417	SRB325
76425	SRB325
76427	SRB311
76438	SRB312
76443	SRB325
76445	SRB325
76449	SRB325
76453	SRB325
76460	SRB325
76464	SRB325
76468	SRB325
76469	SRB325
76470	SRB325
76471	SRB325
76485	SRB325
76486	SRB325
76550	SRB341
76605	SSB103
76606	SSB106
76707	SRB351
76711	SRB335
76715	SRB325
76718	SRB351
76722	SRB325
76725	SRB351
76731	SRB319
76732	SRB321
76734	SRB341
76735	SRB351
76766	SRB325
76767	SRB325
76768	SRB341
76770	SRB335
76771	SRB335
76772	SRB325
76773	SRB325
76775	SRB351
76776	SRB325
76777	SRB335
76783	SRB351
76787	SRB341
76788	SRB351
76789	SRB335
76791	SRB341

CROSS REFERENCE FROM	TO LUCAS PART NUMBER
76792	SRB346
76795	SRB335
76797	SRB351
76798	SRB335
76799	SRB335
76819	SRB346
76843	SRB341
76844	SRB351
76858	SRB335
76871	SRB351
76914	SRB335
76958	SRB333
76968	SRB351
76972	SRB333
76990	SRB341
76999	SRB335
77006	SRB325
77063	SRB351
77099	SRB335
77117	SRB335
77126	SRB335
8FL36	SFB114
9FL12	SFB130
FL51	SFB105
FL54	SFB100
FL55	SFB106
FL59	SFB108
SFB150	SFB166
SFB151	SFB162
SFB152	SFB162
SFB155	SFB162
SFB158	SFB162
SFB180	SFB164
SFB181	SFB167
SFB400	SFB163
SQB104	SQB106
SQB122	SQB106
SQB123	SQB109
SQB402	SQB420
SQB962	SQB106
SRB108	SRB111
SRB120	SRB402
SRB121	SRB111
SRB130	SRB501
SRB130	SRB525
SRB140	SRB501
SRB140	SRB525
SRB200	SRB420
SRB202	SRB511
SRB202	SRB535
SRB203	SRB511
SRB203	SRB535
SRB210	SRB511
SRB210	SRB535
SRB221	SRB511
SRB221	SRB535
SRB318	SRB341
SRB320	SRB341
SRB322	SRB351
SRB323	SRB351
SRB330	SRB335
SRB331	SRB335
SRB334	SRB335
SRB339	SRB341

CROSS REFERENCE FROM	TO LUCAS PART NUMBER
SRB342	SRB341
SRB345	SRB346
SRB349	SRB351
SRB350	SRB351
SRB352	SRB351
YWC10050	SCB314
33997	SPB325
34680	SPB501
36604	SQB411
36605	SQB413
36781	SPB327
36792	SQB511
36796	SPB326
36811	SPB337
36853	SQB404
36877	SPB328
36877	SPB330
36904	SQB142
36905	SQB144
36940	SQB406
36946	SPB335
36946	SPB336
54353271	SPB329
33832	SPB311
54034354	SPB229

**MAGIRUS**

0 116 1143	SRB501
0 116 1143	SRB525
0 116 4015	SRB528
0 116 4016	SRB538
0 116 4017	SRB501
0 116 4017	SRB525
0 116 4018	SRB511
0 116 4018	SRB535
0 116 4648	SRB511
0 116 4648	SRB535
0 116 4678	SRB511
0 116 4678	SRB535
0 117 2944	SRB501
0 117 2944	SRB525

**MAGNETI MARELLI**

RR-38	SRB520
RR-39	SRB530
RR-41	SRB521
RR-82	SRB526
RR-96	SRB522

**MAI**

IE02	SFB162
IE04	SFB165
IE07	SFB165
IE35	SFB162
IE55	SFB165

**MAN**

8125100034	SFB210
81253106038	SFB210
81259020056	SRB501
81259020056	SRB525
81259020102	SRB511
81259020102	SRB535
81259020111	SRB511
81259020111	SRB535









CROSS REFERENCE FROM	TO LUCAS PART NUMBER
<b>RENAULT CONTINUED</b>	
0055 442 300	35703
0071 277 474	30608
1046994	SFB105
1800381	SPB200
1800864	SFB106
1801585	SFB114
36058000	SPB106
37300700	SSB101
37415900	SSB102
77 00 638 976	SFB163
77 00 738 864	SFB163
77 00 810 927	SRB506
77 00 810 928	SRB500
SAV.5000409318	SRB501
SAV.5000409318	SRB525
SAV.5000560865	SRB538
SAV.5516038407	SRB501
SAV.5516038407	SRB525
<b>ROLLS ROYCE</b>	
RD5273	SPB104
RH7261	31284
RH8312	SRB325
UD 11654	SRB511
UD 11806	SRB501
UD 11806	SRB525
UD1511	SFB100
UD18214	SFB130
UD18215	SFB130
UD19431	SFB114
UD22560	34790
UD4653	34790
<b>ROVER</b>	
121269	SRB325
126796	SRB325
13H1606	SRB351
13H2395	SFB106
13H5773	SRB341
13H5952	SRB335
13H6081	30365
13H6342	39314
13H6343	39315
13H7761	39748
13H9603	30771
147277	SQB126
148576	SFB300
148644	SFB114
154577	SFB130
154807	54033632
1601224	SRB325
218498	SQB119
21A2658	SQB189
37H8050	SQB118
537142	SRB351
579085	39415
579202	SRB325
818418	SRB321
83H1010	SFB164
86586550029	SFB162
86786700119	SFB162
AAU1687	SRB351
AAU2186	SRB351

CROSS REFERENCE FROM	TO LUCAS PART NUMBER
AAU3201	30924
AAU3202	30926
AAU3203	30928
AAU4938	SRB335
AAU6936	SFB167
ACU3180	SSB101
ADU1208	SRB335
ADU4938	SRB335
ADU5260	SFB162
ADU5728	SRB335
ADU5827	SRB501
ADU5827	SRB525
AFU4106	SPB248
ATJ8880	SFB130
BAU1022	SQB127
BAU5346	SQB116
BHA5111	39737
BHA5184	39915
BMK1728	SRB325
BMK1736	SFB114
BMK622	SPB106
DRC1424	30713
DRC1820	SRB500
DRC2151	SFB114
DRC2156	SFB130
DRC3160	SQB113
DRC8626	SFB162
EEF100050	SPC100
EO2091	SRB325
EPE100380	SQB154
FBN100020	SPC102
FBU4797	SFB167
FBU7669	SFB164
MBU1101	SFB114
MBU1189	SFB105
MBU1205	SFB300
RG20340	SPB259
RTC430A	SPB200
RTC432A	34790
TKC1112	30563
TKC5089	34224
UKC2416	SRB411
UKC4784	SRB400
UKC7219	SRB400
VKC4379	30731
XPB000040	SQB157
XPB000050	SQB158
XPB000060	SQB159
XPB000280	SQB155
XPB000300	SQB156
XPB10016	SQB106
XPB10021	SQB122
XPB10032	SQB108
XPB101600	SQB175
XPC10003	SQB140
XPC10004	SQB160
XPC100050	SPC101
XPC100140	SQB427
XPC100150	SQB426
XPC100200	SQB183
XPE10006	SQB135
XPE10012	SQB143
XPE10014	SQB141
XPE10015	SQB161

CROSS REFERENCE FROM	TO LUCAS PART NUMBER
XPE10018LNF	SQB109
XPE100320	SQB428
XPE10430	SQB176
XPL100001	SPB228
XUT000020	SPB263
XUT100130	SPB261
XUT100190	SPB262
YUD000660	SPB223
YUD101010	SPB247
YUD101100	SPB224
YUD101120	SPB225
YUE100520	SPB244
YUE100570	SPB222
YUF000360	SPB240
YUF101060	SPB221
YUF101070	SPB226
YUF101080	SPB227
YUF101210	SPB233
YUF101230	SPB229
YUF101380	SPB238
YUF101820	SPB258
YUF101980	SPB232
YUG101570	SPB234
YUG101640	SPB245
YUG101650	SPB256
YUG101660	SPB254
YUG101870	SPB255
YUG101890	SPB253
YUG101900	SPB257
YUG101971	SPB241
YUG101980	SPB243
YUG102030	SPB242
YUG102060	SPB265
YUG103220	SPB266
YUH100250	SPB239
YWB10012	SRB542
YWC10050	SCB314
YWT10002	SFB171
YWT10003	SFB170
YXJ100130	SPB264
YXL100080	SPB235
YXL100100	SPB237
YXL100110	SPB236
<b>RVI</b>	
1801573	SRB325
1802511	SRB341
1802512	SRB351
38141400	SRB351
71801575	SRB335
73163547	SRB346
1801573	SRB325
1802511	SRB341
3062847	35288
36058000	SPB106
36278591	34245
5059108	31788
5430023695	35414
73163547	SRB346
<b>SAAB</b>	
85 83 627	SFB162

CROSS REFERENCE FROM	TO LUCAS PART NUMBER
<b>SAAB-SCANIA</b>	
24 38 79	SRB511
24 38 79	SRB535
<b>SCHIER</b>	
07 0100 10	SRB521
07 0500 10	SRB521
07 1000 10	SRB520
07 1100 10	SRB520
07 3000 00	SRB521
07 3000 00	SRB528
07 3100 00	SRB521
07 3200 00	SRB501
07 3200 00	SRB525
07 3300 00	SRB501
07 3300 00	SRB525
07 3700 00	SRB521
07 3800 00	SRB521
07 4000 00	SRB531
07 4100 00	SRB531
07 4200 00	SRB511
07 4200 00	SRB535
07 4300 00	SRB511
07 4300 00	SRB535
07 4400 00	SRB531
07 7200 00	SRB531
11 0700 00	SRB600
11 0800 00	SRB600
11 0900 00	SRB601
11 1000 00	SRB601
12 0500 00	SRB601
12 0600 00	SRB601
<b>SEAT</b>	
SE022959000A	SFB163
<b>SEDDON ATKINSON</b>	
20707	SPB104
212215S1	SQB223
212218	35476
212738S1	SQB222
21363591	SPB203
21471591	SRB341
215078S1	SRB351
23465	SFB100
63422	SSB101
64000	SRB113
6762151	SRB511
6762151	SRB535
<b>SEV</b>	
EFU14	SFB163
EFU3	SFB161
EFU3	SFB162
HD12	SFB161
<b>SEV MARCALL</b>	
915000012	SRB522
915000022	SRB532
915000112	SRB520
915000312	SRB501
915000312	SRB525
915000322	SRB511
915000322	SRB535







The power to SWITCH

CROSS REFERENCE FROM	TO LUCAS PART NUMBER
<b>UNIPART CONTINUED</b>	
GTM8003	SRB143
GTM8004	SRB146
GTM8011	SRB400
GTM8012	SRB402
GTM8013	SRB411
GTM8015	SRB506
GTM8028	SRB520
GTM8029	SRB522
GTM8030	SRB528
GTM8031	SRB529
GTM8036	SRB537
GTM8038	SRB539
GTM8039	SRB540
GTM8041	SRB600
GTM8043	SRB630
GTM8044	SRB631
GTM8055	SRB502
GTM8056	SRB500
GTM8057	SRB501
GTM8058	SRB521
GTM8059	SRB523
GTM8061	SRB526
GTM8062	SRB527
MBK622	SPB106
MBU1205	SFB300
MBU2068	SPB120
MBU2128	35476
PRC2124	SRB420
PRC2278	35367
PRC2497	35283
PRC2734	35288
PRC2735	35289
PRC2956	SQB128
PRC3430	SQB129
PRC3875	SQB965
PRC3900	SQB130
PRC4155	33940
PRC5610	34889
PTIS100	SPB108
RTC0431	SRB111
RTC0432	34790
RTC430A	SPB200
RTC430D	SPB200
RTC432	34790
RTC432A	34790
RTC432J	34790
SAC1028D	SRB411
TKC1112	30563
TKC5089	34224
UKC2416	SRB411
UKC4379	30731
UKC7219	SRB400
XPB10016	SQB106
XPB10021	SQB122
XPB10047LNF	SQB108
XPC10003	SQB140
XPC10004	SQB160
XPE10006	SQB135
XPE10012	SQB143
XPE10014	SQB141
XPE10015	SQB161
XPE10018LNF	SQB109

CROSS REFERENCE FROM	TO LUCAS PART NUMBER
<b>UNIPOINT</b>	
LR-1111	SRB520
LR-1112	SRB530
LR-1221	SRB528
LR-1222	SRB538
LR-1331	SRB500
LR-1332	SRB510
LR-2111	SRB520
LR-2112	SRB530
LR-2221	SRB528
LR-2222	SRB538
LR-2331	SRB501
LR-2331	SRB525
LR-2332	SRB511
LR-2332	SRB535
<b>VAG</b>	
141 951 253 A	SRB520
183 951 253	SRB530
1J0 906 381A	FDB516
321 906 059 E	FDB510
321 906 059 F	FDB510
321 906 059 G	FDB511
321 906 059 H	FDB508
321 906 363	FDB507
357 906 381	FDB516
431 951 253	SRB520
431 951 253 C	SRB529
433 906 059	FDB510
443 906 059 A	FDB510
443 907 385	FDB510
443 907 385 B	FDB511
443 907 385 C	FDB509
443 907 385 F	FDB509
443 907 385 G	FDB508
443 907 385 H	FDB508
443 907 385 J	FDB509
X03 952 671	FDB505
<b>VALEO</b>	
2474	FDB506
251570	SQB511
641403	SFB163
641408	SFB166
643102	SRB501
643102	SRB525
643105	SRB511
643105	SRB535
643283	SRB507
643501	SRB500
643501	SRB525
643504	SRB501
643504	SRB525
643507	SRB501
643507	SRB525
643508	SRB501
643508	SRB525
643512	SRB506
643514	SRB501
643514	SRB525
643518	SRB500
643518	SRB525
643523	SRB510
643523	SRB535

CROSS REFERENCE FROM	TO LUCAS PART NUMBER
643526	SRB511
643526	SRB535
643601	SRB520
643607	SRB520
643608	SRB520
643701	SRB528
643702	SRB528
91500112	SRB520
91500122	SRB530
91500312	SRB520
91500322	SRB511
91500322	SRB535
<b>VAUXHALL</b>	
914850	SPB108
<b>VITRON</b>	
73365	SFB163
<b>VOLKSWAGEN</b>	
191 953 227 A	SFB162
431 953 231	SFB164
<b>VOLVO</b>	
1578869	SFB210
4787201	SFB210
1096413	SQB737
1235893	SRB521
1235893	SRB528
1323317-6	SFB164
1324492	SRB506
1363786-3	SFB162
1501833	SRB531
1501833	SRB538
1504951	SRB511
1504951	SRB535
1579255	SQB732
1579255	SQB733
263230	SRB523
268774	SRB523
268775	SRB527
3172171	SQB737
3273203-4	SFB162
3456040-9	SFB182
70351704	SQB738
8154792	SQB732
8154792	SQB733
8158723	SQB738
839 424	SRB538
<b>VOLVO LEYLAND</b>	
108653321	SRB511
108653321	SRB535
10901658	39798
10903725	31780
143804	SPB140
1699444	SPB203
204045	SPB105
238110	31284
35RF8884	SPB160
505182	SPB104
6866679	SSB100
8226396-3	SRB511
8226396-3	SRB535
AAU8403	SRB420

CROSS REFERENCE FROM	TO LUCAS PART NUMBER
ABU3311	54033632
ACU3180	SSB101
AFU2883	SRB511
AFU2883	SRB535
BBU1363	33888
BMK0622	SPB106
CAL3434	33838
<b>WEHRLE</b>	
20 200 100	SRB520
20 200 111	SRB600
20 201 000	SRB525
20 206 100	SRB526
20 207 100	SRB528
20 210 000	SRB523
20 211 100	SRB527
20 400 111	SRB601
20 401 000	SRB535
20 403 100	SRB531
20 410 100	SRB533
50205002	FDB504
50205603	FDB504
51204003	FDB503
51223908	FDB501
51223909	FDB501
54201001	SFB162
54201003	SFB164
54201006	SFB164
54201101	SFB162
54201103	SFB164
54201108	SFB165
54203001	SFB162
54204002	SFB165
54401101	SFB166
54401102	SFB166
<b>WIPAC</b>	
WFL12	SFB182
WFL16	SFB167
WFL18	SFB166
WFL22	SFB170
WFL3	SFB114
WFL4	SFB153
WFL5	SFB105
WFL6	SFB163
WFL8	SFB165
WFL9	SFB161





A large, empty rectangular box with a thin black border, intended for handwritten notes.





A large, empty rectangular box with a thin black border, intended for taking notes.



# The power of EXCELLENCE

Lucas



The power of EXCELLENCE



- UK aftermarket's number one bulb supplier
- High quality standard complying with EU legislation
- Traditional Lucas Switchgear available including Ignition switches, Panel switches, Relays, Flashers, Solenoids and Column Switchgear

+44 (0) 1675 466 999

Lucas



The power of VISION



- Extensive range of Headlamps, Signal Lamps and Rear lamps
- Best in market range of complete Door Mirrors, Covers and Mirror glass
- UK specific range
- All products 'E' approved

+44 (0) 1543 495 555

Lucas



The power of PERFORMANCE



- Range targets 98% coverage of the UK parc for car and light commercial vehicles
- Coverage on key heavy goods vehicles, agricultural and off-road applications
- First major brand to market with a nationwide two-year warranty
- Pro-active 'First to Market' approach

+45 (0) 7010 1313

Lucas



The power to ALERT



- Redesigned Rotating Beacons programme now features an ultra-low profile for maximum impact protection and improved light output
- Extended and updated Mini Lightbar programme
- Improved Reverse Alarms range, includes standard, night silent, night reduced and self-adjusting Smart Alarm models

+44 (0) 113 237 5555

Lucas



The power of ENERGY



- With 99% vehicle parc coverage, the Lucas branded battery programme is the top choice for the UK aftermarket
- **Supreme Lucas Battery Range**  
High power units, built to cope with the increasing electrical demands of modern cars
- **Premium Lucas Battery Range**  
OE quality for cars and commercial vehicles offering three year and two year guarantees respectively

+44 (0) 1536 408 901

Lucas



The power to CONTROL



- Switches and sensors, fuelling and emissions components, ignition parts and HT leads
- Comprehensive All-makes Lambda Sensors range offering both universal and direct fit applications
- Comprehensive All Makes programme backed by detailed customer advice
- All parts are manufactured to exact original equipment specification

+44 (0) 115 964 6789

*The World's most durable and highly respected name in the automotive industry*

# *The World's most durable and highly respected name in the automotive industry*

Today, the philosophy behind Lucas is to drive continued brand quality, leadership and evolution, maintaining the philosophy of superior engineering and excellent service that the brand represents. It is our goal to maintain the aftermarket leadership of all the Lucas branded programmes and continue "first-to-market" range extensions, whilst offering superior cataloguing and the most effective, responsive customer support in the sector.



*The power of EXCELLENCE*

Lucas Electrical  
27 Roman Way, Coleshill, Birmingham B46 1HQ  
Tel: +44 (0) 1675 466999 Fax: +44 (0) 1675 466686  
[www.lucaselectrical.co.uk](http://www.lucaselectrical.co.uk)